



DIGITAL CAMERA

OM SYSTEM

OM-5

Instruction Manual

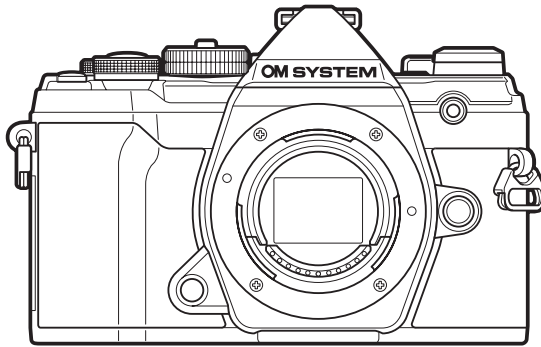

EN

Model No. : IM030

- Thank you for purchasing our digital camera. Before you start to use your new camera, please read these instructions carefully to enjoy optimum performance and a longer service life.
- **Be sure you have read and understood the contents of “SAFETY PRECAUTIONS”, before using this product. Keep these instructions available for future reference.**
- We recommend that you take test shots to get accustomed to your camera before taking important photographs.
- The screen and camera illustrations shown in this manual were produced during the development stages and may differ from the actual product.
- If there are additions and/or modifications of functions due to firmware update for the camera, the contents will differ. For the latest information, please visit our website.

Table of Contents

Introduction	14
Before You Begin	14
User Registration	14
Installing PC Software/Apps	15
About This Manual	16
How to find what you want to know	16
How to read this manual	17
Names of parts	18
Preparation	20
Unpacking the box contents	20
Attaching the Strap	21
Inserting and removing the battery	22
Inserting the battery	22
Removing the battery	23
Charging the Battery using the supplied USB-AC adapter	24
Charging the Battery Using an Optional BCS-5 Battery Charger	26
Inserting and Removing Memory Cards	27
Inserting the card	27
Removing the card	28
Usable cards	28
Attaching and removing lenses	29
Attaching a lens to the camera	29
Removing Lenses	30
Using the monitor	31
Turning the camera on	32
Sleep Mode	33
Initial setup	34
What to Do If You Can't Read the Display	36
Shooting	37
Information displays while shooting	37

Switching between displays.	40
Switching the information display.	41
Shooting still pictures.	43
Types of shooting modes.	43
Shooting with touch screen operations.	46
Letting the camera choose aperture and shutter speed (P : Program AE).	48
Program Shift.	50
Choosing aperture (A : Aperture-Priority AE).	51
Choosing shutter speed (S : Shutter-Priority AE).	53
Choosing aperture and shutter speed (M : Manual Exposure).	55
Using Exposure Compensation in Mode M.	57
Long Exposures (B : Bulb/Time).	58
Bulb/Time Photography.	58
Lighten Blending (B : Live Composite Photography).	62
Letting the camera choose the settings (AUTO mode).	64
Shooting in scene mode (SCN mode).	67
Types of scene modes.	68
Shooting a Panorama.	71
Using art filters (ART mode).	73
Types of art filters.	74
Using [Partial Color].	76
Saving Custom Settings to the Mode Dial (C Custom mode).	77
Saving Settings (Assign to Custom Mode).	77
Using Custom Modes (C).	79
Recording Movies.	82
Recording movies in photo shooting modes.	82
Recording movies in movie mode ().	83
Touch Controls (Silent Controls).	84
Shooting Settings.	86
Shooting Settings.	86
Direct Buttons.	87

Direct Buttons.	87
Controlling exposure (Exposure Compensation).	89
Adjusting Exposure Compensation.	90
Resetting Exposure Compensation.	90
Choosing an AF Target Mode (AF Target Mode).	91
AF Target Modes.	91
Choosing a Focus Target (AF Target Point).	95
Zoom frame AF/Zoom AF (Super Spot AF).	96
Changing ISO sensitivity (ISO).	98
Locking Exposure (AE Lock).	100
Performing the sequential/self-timer shooting.	101
Self-Timer Options (⌚ Custom Self-timer).	104
Shooting without the vibration caused by shutter button operations (Anti-Shock [⬢]).	105
Shooting without shutter sound (Silent [♥]).	106
Shooting without a release time lag (Pro Capture shooting).	107
Pro Capture Photography.	108
Shooting still pictures in a higher resolution (High Res Shot).	109
The Super Control/LV Super Control Panel.	111
The Super Control and LV Super Control Panels.	111
Using the Super Control and LV Super Control panels.	113
Settings Available in the Super Control/LV Super Control Panel.	115
Changing ISO sensitivity (ISO).	117
Choosing a focus mode (AF Mode).	118
Adjusting Focus Manually During Autofocus.	120
Using Starry Sky AF.	121
Setting a focus position for PreMF.	122
Positioning and Sizing the AF Target (AF Area).	123
Choosing how the camera measures brightness (Metering).	124
Face priority AF/Eye priority AF (☺ Face Priority).	126
Adjusting color (WB (white balance)).	129
One-touch white balance.	131
WB AUTO Keep Warm Color.	132

Making fine adjustments to white balance (WB Compensation)	133
Reducing camera shake (Image Stabilizer)	134
Performing the sequential/self-timer shooting	137
Setting the image aspect	138
Photo File and Image Size Options (📷🔌).	139
Frame Size, Rate, and Compression (📺🔌).	141
The Movie Quality Icon	142
Filming High-Speed Movies	144
Filming Slow- or Fast-Motion Movies (Slow- and Fast-Motion Movies)	146
Using a flash (Flash photography)	147
Attaching Compatible Flash Units	147
Removing Flash Units	148
Choosing a Flash Mode (Flash Mode)	149
Flash Modes	150
Flash Mode and Shutter Speed	151
Adjusting flash output (Flash intensity control)	153
Processing options (Picture Mode)	154
Picture mode options	154
Adjusting overall color (Color Creator)	157
Making fine adjustments to sharpness (Sharpness)	158
Making fine adjustments to contrast (Contrast)	159
Making fine adjustments to saturation (Saturation)	160
Making fine adjustments to tone (Gradation)	161
Applying filter effects to monochrome pictures (Color Filter)	162
Adjusting the tone of a monochrome image (Monochrome Color)	163
Adjusting i-Enhance effects (Effect)	164
Setting the color reproduction format (Color Space)	165
Changing the brightness of highlights and shadows (Highlight&Shadow Control)	166
Assigning functions to buttons (Button Function)	167
Customizable Controls	167
Available Roles	169
Using multi function options (Multi Function)	176



















































Adjusting Zoom During Filming (Movie ).....	177
Playback.....	179
Information display during playback.....	179
Playback image information.....	179
Switching the information display.....	181
Viewing photographs and movies.....	182
Viewing photographs.....	182
Watching movies.....	183
Finding Pictures Quickly (Index and Calendar Playback).....	185
Zooming In (Playback Zoom).....	186
Rotating Pictures (Rotate).....	187
Protecting Pictures ().....	188
Deleting Pictures (Erase).....	189
Selecting Pictures for Sharing (Share Order).....	190
Selecting RAW+JPEG Pictures for Sharing.....	190
Selecting Multiple Pictures (Share Order Selected,  , Erase Selected).....	192
Print order (DPOF).....	193
Creating a print order.....	193
Removing all or selected pictures from the print order.....	194
Adding Audio to Pictures ().....	196
Audio Playback.....	197
Playback Using Touch Controls.....	198
Full-Frame Playback.....	198
Index/Calendar Playback.....	199
Other Functions.....	199
Menu Functions.....	200
Basic menu operations.....	200
Using Shooting Menu 1/Shooting Menu 2.....	203
Shooting Menus 1 and 2.....	203
Restoring Default Settings (Reset).....	204
Saving Settings (Assign to Custom Mode).....	205
Processing options (Picture Mode).....	206





Photo File and Image Size Options (📷🔍).	207
Digital Zoom (Digital Tele-converter).	208
Shooting automatically with a fixed interval (Intrvl. Sh./Time Lapse).	209
High Resolution Shooting Settings (High Res Shot).	212
Slowing the Shutter in Bright Light (Live ND Shooting).	213
Varying settings over a series of photographs (Bracketing).	216
Using Bracketing.	221
Taking HDR (High Dynamic Range) images (HDR).	224
Recording multiple exposures in a single image (Multiple Exposure).	227
Keystone correction and perspective control (Keystone Comp.).	230
Setting anti-shock/silent shooting (Anti-Shock [🔊]/Silent [🔇]).	232
Using the Video Menu.	233
The Video Menu.	233
Choosing an Exposure Mode (📽 Mode (Movie Exposure Mode)).	238
Reducing Flicker Under LED Lighting (📽 Flicker Scan).	240
Frame Size, Rate, and Compression (📽🔍).	242
Assigning Roles to the Front and Rear Dials (📽 Dial Function).	244
Sound Recording Options (Movie 🎙).	246
Using the Playback Menu.	248
The Playback Menu.	248
Automatically Rotating Portrait-Orientation Pictures for Playback (📷🔄).	249
Retouching Pictures (Edit).	250
Retouching RAW Pictures (RAW Data Edit).	250
Retouching JPEG Pictures (JPEG Edit).	253
Combining Pictures (Image Overlay).	256
Creating Movie Stills (In-Movie Image Capture).	257
Trimming movies (Movie Trimming).	258
Removing Protection from All Pictures (Reset Protect).	260
Cancelling a share order (Reset share Order).	261
Using the Setup Menu.	262
The Setup Menu.	262
Formatting the card (Card Setup).	264

Deleting all images (Card Setup)	265
Using “My Menu”	266
My Menu	266
Adding Items to My Menu	266
Managing “My Menu”	268
Using the Custom Menus	269
The Custom Menus	269
A1 A2 A3 A4 AF/MF	270
A1 AF/MF	270
A2 AF/MF	271
A3 AF/MF	273
A4 AF/MF	273
B Button/Dial	275
B Button/Dial	275
C1 C2 Release/  /Image Stabilizer	277
C1 Release/  /Image Stabilizer	277
C2 Release/  /Image Stabilizer	277
D1 D2 D3 D4 Disp/  /PC	279
D1 Disp/  /PC	279
D2 Disp/  /PC	280
D3 Disp/  /PC	281
D4 Disp/  /PC	282
E1 E2 E3 Exp/ISO/BULB/ 	284
E1 Exp/ISO/BULB/ 	284
E2 Exp/ISO/BULB/ 	285
E3 Exp/ISO/BULB/ 	286
F  Custom	287
F  Custom	287
G  /WB/Color	288
G  /WB/Color	288

H1 H2 Record/Erase	290
H1 Record/Erase	290
H2 Record/Erase	292
I EVF	293
I EVF	293
J1 J2  Utility	295
J1  Utility	295
J2  Utility	296
Combined Auto and Manual Focus ( AF+MF)	298
Setting Focus and Exposure with the AEL/AFL Button ( AEL/AFL)	299
C-AF Tracking Sensitivity ( C-AF Sensitivity)	302
C-AF Starting Focus Target ( C-AF Center Start)	303
C-AF Center Target Priority ( C-AF Center Priority)	304
Choosing the AF Home Position ( Set Home)	305
AF-Target Selection ( Select Screen Settings)	307
Enabling AF-Target Selection Wrap ( Loop Settings)	308
AF Target Size and Positioning ( Target Mode Settings)	309
Matching AF-Target Selection to Camera Orientation ( Orientation Linked )	310
Lens Focus Range (AF Limiter)	312
Fine-Tuning Autofocus (AF Focus Adj.)	313
Deleting Saved Values	315
Enabling Fine-Tuning	316
Manual Focus Assist (MF Assist)	317
Adjusting Focus During Exposures (Bulb/Time Focusing)	318
Assigning Roles to the Front and Rear Dials ( Dial Function)	319
Customizing the Fn Lever ( Fn Lever Function)	321
Burst Shooting Options ( L Settings/  H Settings)	322
Reducing Flicker (Flicker Reduction)	325
Reducing Flicker in Live View (Anti-Flicker LV)	325
Reducing Flicker in Photographs (Anti-Flicker Shooting)	327
Choosing the control panel displays ( Control Settings)	329

Displaying On-Screen Controls.	330
Live Controls.	331
Adding information displays ( /Info Settings).	332
 Info (Playback information displays).	332
  Info (Magnified playback information display).	333
LV-Info (Shooting information displays).	333
LV OFF-Info (Shooting information displays).	333
 Settings (Index/calendar display).	334
Choosing the Playback Zoom Ratio (  Default Setting).	335
Selfie Assist (Selfie Assist).	336
Viewing camera images on TV (HDMI).	337
Choosing a USB Connection Mode (USB Mode).	339
Live Bulb Update Frequency (Live Bulb).	340
Live Time Update Frequency (Live Time).	341
Choosing the Shutter Speed (Composite Settings).	342
Reducing Flicker Under LED Lighting ( Flicker Scan).	343
Fine-Tuning Exposure (Exposure Shift).	345
Shutter speeds when the flash fires ( X-Sync./  Slow Limit).	346
Combinations of JPEG image sizes and compression rates ( Set).	347
Saving lens info (Lens Info Settings).	348
Selecting the display style of the viewfinder (EVF Style).	349
Viewfinder display when shooting using the viewfinder (Style 1/Style 2).	350
Viewfinder Info Display Options ( Info Settings).	351
Button Hold Options (Press-and-hold Time).	352
Correcting Fisheye Distortion (Fisheye Compensation).	353
Connecting the Camera to External Devices.	355
Connecting to External Devices.	355
Precautions for Using Wi-Fi and Bluetooth [®]	356
Disabling the Camera's Wireless Functions.	357
Connecting the Camera to a Smartphone.	358
Connecting to Smartphones.	358
Pairing the Camera and Smartphone.	359

Wireless Connection Standby Setting for When the Camera Is On.	361
Wireless Settings for When the Camera Is Off.	362
Select.	363
Transferring images to a smartphone.	364
Automatically uploading images while the camera is off.	365
Shooting remotely with a smartphone (Live View).	366
Shooting remotely with a smartphone (Remote Shutter).	367
Adding position information to images.	368
Resetting wireless LAN/ Bluetooth ® settings.	369
Changing the password.	370
Connecting the Camera to a Computer.	371
Copying pictures to a computer.	371
Installing the PC software.	373
Using the Camera as a Webcam (Webcam).	374
Using the Remote Control.	376
Names of parts.	376
Connection.	377
Wired connection.	377
Wireless connection.	377
Deleting pairing.	379
Shooting from the remote control.	380
Data transfer indicator of the remote control.	381
MAC address of the remote control.	382
Precautions for using the remote control.	383
Connecting to TVs or External Displays via HDMI.	384
Connecting the Camera to TVs or External Displays (HDMI).	384
Viewing Pictures on a TV (HDMI).	385
HDMI Output.	385
Connecting the Camera to a TV.	387
Using a TV Remote (HDMI Control).	388
Default Settings.	390
Default Settings.	390

Live Controls/LV Super Control Panel.	391
 Shooting Menus.	396
 Video Menu.	400
 Playback Menu.	404
 Setup Menu.	405
 Custom Menus.	406
Memory Card Capacity.	422
Memory Card Capacity: Photos.	422
Memory Card Capacity: Movies.	424
Cautions.	425
Information about Dust and Water Resistant Features.	425
Precautions.	425
Maintenance.	425
Batteries.	426
Using your USB-AC adapter abroad.	427
Information.	428
Interchangeable lenses.	428
Lens and camera combinations.	428
MF Clutch Lenses.	429
Camera Displays for Lens SET and CALL Functions.	430
Optional Accessories.	431
Grip (ECG-5).	431
Designated External Flash Units.	432
Wireless remote control flash photography.	434
Other external flash units.	437
Principal Accessories.	438
Accessories.	439
Cleaning and storing the camera.	443
Cleaning the camera.	443
Storage.	443
Inspecting and Cleaning the Image Sensor.	444
Pixel Mapping - Checking the image processing functions.	444

Shooting tips and information.	445
The camera does not turn on even when a battery is loaded.	445
A dialog prompting you to choose a language is displayed.	445
No picture is taken when the shutter button is pressed.	445
The number of AF targets is reduced.	446
The date and time has not been set.	447
Set functions are restored to their factory default settings.	447
Pictures are "washed out".	447
Unknown bright dot(s) appear on the subject in the picture taken.	448
Functions that cannot be selected from menus.	448
Functions that cannot be set from the super control panel.	448
The subject appears distorted.	448
Lines appear in photographs.	448
Only the subject is displayed and no information is shown.	449
Focus mode cannot be changed from MF (manual focus).	449
Nothing is displayed on the monitor.	449
Error codes.	450
Specifications.	452
Camera.	452
Lithium-ion battery.	457
USB-AC adapter.	457
SAFETY PRECAUTIONS.	459
SAFETY PRECAUTIONS.	459
General Precautions.	459
⚠ WARNING.	460
⚠ CAUTION.	462
⚠ NOTICE.	462
Trademarks.	465

Introduction

Before You Begin

Read and Follow Safety Precautions

To prevent incorrect operation resulting in fire or other damage to property or harm to yourself or to others, read [“SAFETY PRECAUTIONS” \(P. 459\)](#) in its entirety before using the camera.

While using the camera, consult this manual to ensure safe and correct operation. Be sure to keep the manual in a safe place once it is read.

Our company will not be held liable for violations of local regulations arising from use of this product outside the country or region of purchase.

Wireless LAN and Bluetooth®

The camera features built-in wireless LAN and **Bluetooth®**. Use of these features outside the country or region of purchase may violate local wireless regulations; be sure to check with local authorities before use. Our company will not be held liable for the user's failure to comply with local regulations.

Disable wireless LAN and **Bluetooth®** in areas where their use is prohibited.  [“Disabling the Camera's Wireless Functions” \(P. 357\)](#)

User Registration

Be sure to register your purchase. Visit our website for information on registering your products.

Installing PC Software/Apps

OM Workspace

This computer application is used to download, view, and edit photos and movies recorded with the camera. It can also be used to update the camera firmware. The software can be downloaded from our website. Be prepared to provide the camera serial number when downloading the software.



OM Image Share

Download pictures marked for sharing to your smartphone. You can also operate the camera remotely and take pictures from a smartphone. Visit our website for information about the application.

About This Manual

How to find what you want to know







You can use the following methods to find what you want to know in this manual.

Search method	Where to look
Search based on what you want to do	 "Table of Contents"
Search based on names of buttons and parts of the camera	 "Names of parts" (P. 18)
Search based on menus and terms displayed on the monitor	 "Default Settings" (P. 390)

How to read this manual

Symbols in this manual

The following symbols are used throughout this manual.

	Indicates an operation performed using the front dial (a).
	Indicates an operation performed using the rear dial (b).
	Indicates an operation performed by pressing the buttons (respectively the up, down, left, and right arrow buttons) on the arrow pad (c).
	Cautions and limitations.
	Tips and other helpful information for using the camera.
	References to other pages in this manual.

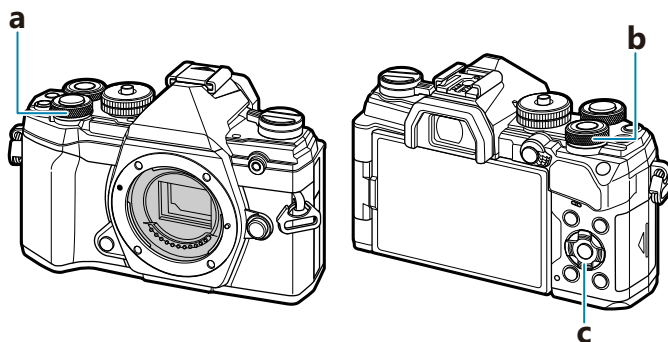

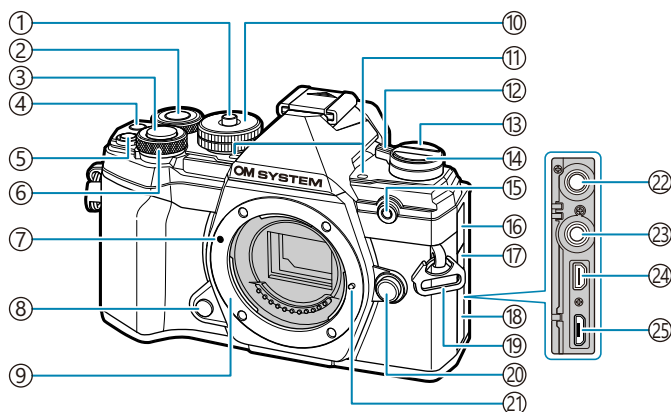

Names of parts

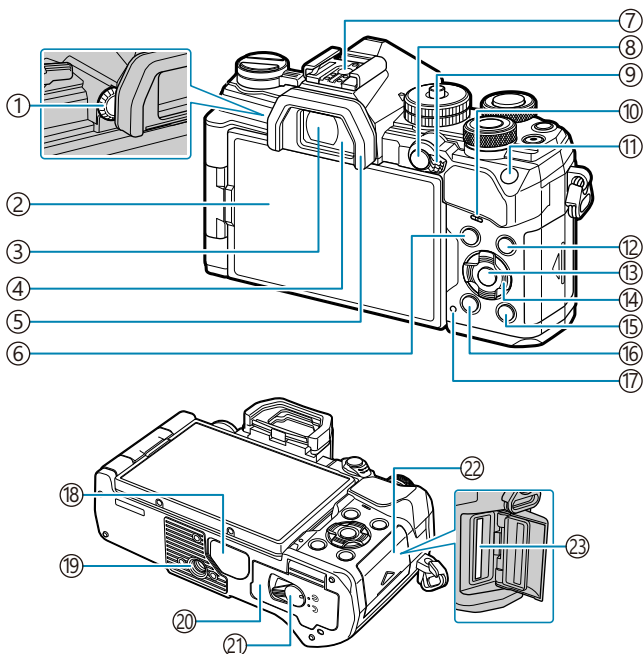

- ① Mode dial lock (P. 43)
- ② Rear dial (P. 182, P. 244, P. 275, P. 319)
- ③ Shutter button (P. 43)
- ④ / button (P. 82, P. 192, P. 233, P. 275)
- ⑤ (exposure compensation) button (P. 89)
- ⑥ Front dial (P. 182, P. 244, P. 275, P. 319)
- ⑦ Lens attachment mark (P. 29)
- ⑧ Preview button (P. 169)
- ⑨ Mount (Remove the body cap before attaching the lens.)
- ⑩ Mode dial (P. 43)
- ⑪ Stereo microphone (P. 196, P. 246)
- ⑫ **ON/OFF** lever (P. 22)
- ⑬ (**LV**) (P. 40)
- ⑭ (sequential shooting/self-timer) button (P. 101)
- ⑮ Self-timer lamp/AF illuminator (P. 101, P. 273)
- ⑯ Microphone jack cover
- ⑰ Remote cable terminal cover
- ⑱ Connector cover
- ⑲ Strap eyelet (P. 21)
- ⑳ Lens release button (P. 30)
- ㉑ Lens lock pin
- ㉒ Microphone jack (A commercially available microphone can be connected. ø3.5 stereo mini plug) (P. 246)
- ㉓ Remote cable terminal (P. 439)
- ㉔ HDMI connector (type D) (P. 233, P. 337)
- ㉕ Micro-USB connector (P. 24, P. 371)



- ① Diopter adjustment dial (P. 40)
- ② Monitor (touch screen) (P. 37, P. 40, P. 46, P. 179, P. 198, P. 295)
- ③ Viewfinder (P. 40, P. 349)
- ④ Eye sensor (P. 40, P. 293)
- ⑤ Eyecup (P. 438)
- ⑥ **MENU** button (P. 200)
- ⑦ Hot shoe (P. 147, P. 432)
- ⑧ **AEL/AFL/O-m** (protect) button (P. 100, P. 299, P. 188)
- ⑨ **Fn** lever (P. 233, P. 321)
- ⑩ Speaker
- ⑪ **ISO** button (P. 98)
- ⑫ **INFO** button (P. 41, P. 181)
- ⑬ **OK** button (P. 111, P. 182, P. 200)
- ⑭ Arrow pad (P. 182)
- ⑮  (playback) button (P. 182)
- ⑯  (erase) button (P. 189)
- ⑰ **CHARGE** (battery charge) lamp (P. 24)
- ⑱ Connector cover
- ⑲ Tripod socket
- ⑳ Battery compartment cover (P. 22)
- ㉑ Battery compartment lock (P. 22)
- ㉒ Card compartment cover (P. 27)
- ㉓ Card slot (P. 27)

Preparation

Unpacking the box contents

At purchase, the package contains the camera and the following accessories.
If anything is missing or damaged, contact the dealer from whom you purchased the camera.



Camera



Body cap ¹



EP-15 eyecup ¹



Hot shoe cover ¹



Strap

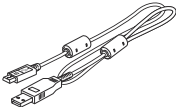

USB cable CB-USB12



Lithium-ion battery BLS-50

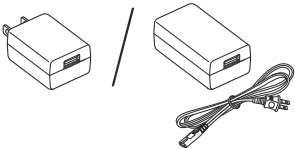

USB-AC adapter F-5AC

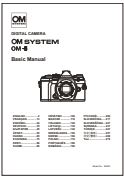

Basic Manual

Warranty Card

¹ The body cap, eyecup, and hot shoe cover come attached to or inserted in the camera.

 The battery will not be fully charged at the time of purchase. Charge the battery before use ([P. 24](#)).

Attaching the Strap

1. Before attaching the strap, remove the end from the keeper loop and loosen the strap as shown.

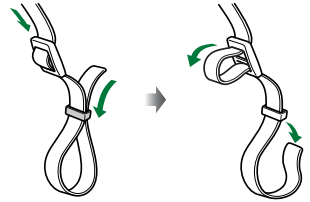

2. Pass the end of the strap through the strap eyelet and back through the keeper loop.

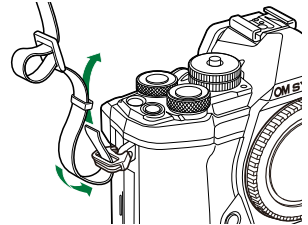

3. Pass the end of the strap through the buckle and tighten as shown.

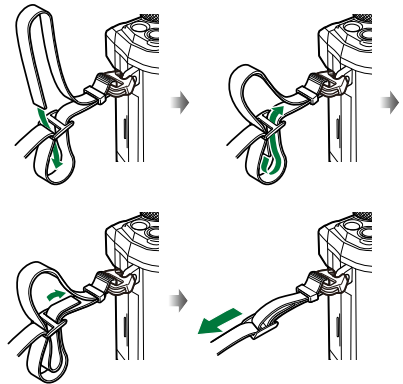

- Attach the other end of the strap to the other eyelet.
- After attaching the strap, pull on it firmly to ensure that it will not come loose.

Inserting and removing the battery

Inserting the battery

1. Confirm that the **ON/OFF** lever is in the **OFF** position.

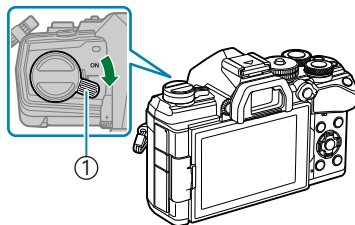

① ON/OFF lever

2. Open the battery compartment cover.

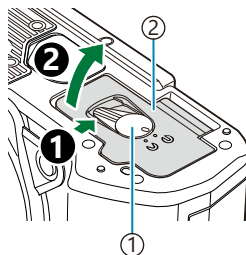

① Battery compartment lock
② Battery compartment cover

3. Insert the battery.
 - Use only BLS-50 batteries (P. 20, P. 439).

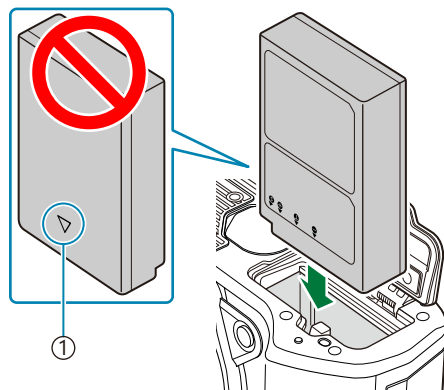

① Direction indicating mark

4. Close the battery compartment cover.

🔧 It is recommended to set aside a backup battery for prolonged shooting in case the battery in use drains.

🔧 See also ["Batteries" \(P. 426\)](#).

Removing the battery

Turn off the camera before opening or closing the battery compartment cover. To remove the battery, first push the battery lock knob in the direction of the arrow and then remove.

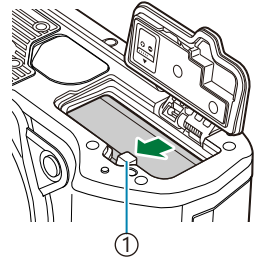

① Battery lock knob

- ⚠ Contact an authorized distributor or service center if you are unable to remove the battery. Do not use force.
- ⚠ Never remove batteries or memory cards while the card write indicator ([P. 37](#)) is displayed.

Charging the Battery using the supplied USB-AC adapter

⚠ The battery will not be fully charged at the time of purchase. Charge the battery before use.

1. Confirm that the **ON/OFF** lever is in the **OFF** position.

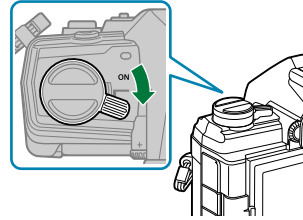

2. Connect the USB cable and USB-AC adapter and plug the adapter in.

⚠ Refrain from using anything other than the USB cable (CB-USB12) supplied with the camera or sold separately.

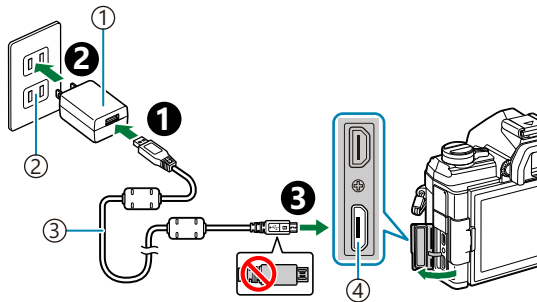

- ① USB-AC adapter (supplied)
- ② AC outlet
- ③ USB cable (supplied)
- ④ Micro-USB connector

- The CHARGE lamp lights while charging is in progress. Charging takes about 4 hours. The lamp goes out as the batteries reach full charge. Remove the USB cable from the camera.

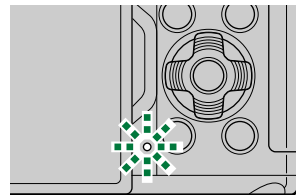

- ⚠ If a charging error occurs, the CHARGE lamp will blink. Disconnect and reconnect the USB cable.

⚡ Charging stops when the battery temperature is too high. It will resume after the battery temperature falls.

⚡ For safety reasons, charging may take longer, or the battery may not reach full charge, when the battery is charged in a high-temperature environment.

ⓘ **The USB-AC Adapter**

Be sure to unplug the USB-AC adapter for cleaning. Leaving the USB-AC adapter plugged in during cleaning could result in injury or electric shock.

Charging the Battery Using an Optional BCS-5 Battery Charger

1. Charge the battery.

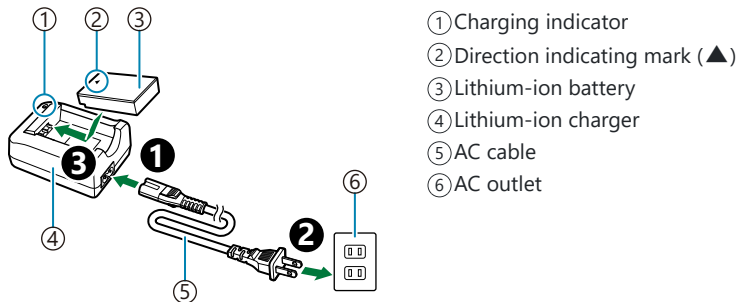

- ① Charging indicator
- ② Direction indicating mark (▲)
- ③ Lithium-ion battery
- ④ Lithium-ion charger
- ⑤ AC cable
- ⑥ AC outlet

Charging indicator

Charging in progress	Lights orange
Charging complete	Off
Charging error	Blinks orange

(Charging time: Approximately 3 hours 30 minutes)

- Unplug the charger when charging is complete.

Inserting and Removing Memory Cards

Inserting the card

In this manual, all storage devices are referred to as “cards”. The following types of SD memory card (commercially available) can be used with this camera: SD, SDHC, and SDXC.

Cards must be formatted with this camera before first use or after being used with other cameras or computers.  [“Formatting the card \(Card Setup\)” \(P. 264\)](#)

1. Confirm that the **ON/OFF** lever is in the **OFF** position.

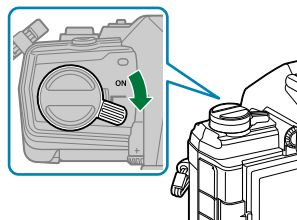

2. Open the card compartment cover.

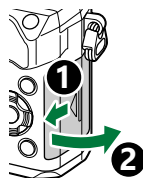

3. Insert the card.
 - Slide the card in until it locks into place.

 Do not forcibly insert a damaged or deformed card. Doing so may damage the card slot.

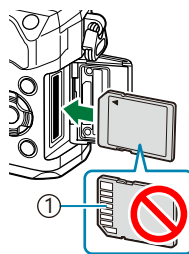

① Terminal area

4. Close the card compartment cover.
 - Close it securely until you hear it click.

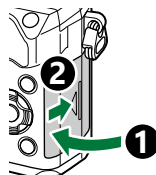

Removing the card

Press the card in to eject it. Pull out the card.

- ⓘ Never remove batteries or memory cards while the card write indicator (P. 37) is displayed.

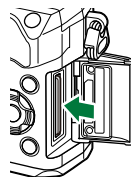

Usable cards

In this manual, all storage devices are referred to as “cards”. The following types of SD memory card (commercially available) can be used with this camera: SD, SDHC, and SDXC. For the latest information, please visit our website.



SD card write protect switch

The SD card body has a write protect switch. Setting the switch to “LOCK” prevents data being written to the card. Return the switch to the unlock position to enable writing.



- ⓘ When recording movies, use an SD card that supports an SD speed class of 10 or higher.
- ⓘ A UHS-II or UHS-I card with a UHS speed class of 3 or better is required when:
 - a resolution of **[4K]** or **[C4K]** is selected in the **[⊞ ◀]** menu, or
 - a bit rate of **[A-I]** (All-Intra) is selected in the **[⊞ ◀]** menu.
- 🔒 The data in the card will not be erased completely even after formatting the card or deleting the data. When discarding, destroy the card to prevent leakage of personal information.
- 🔒 Access to some playback functions and the like may be restricted when the write-protect switch is in the “LOCK” position.

Attaching and removing lenses

Attaching a lens to the camera

For information on interchangeable lenses, see “Interchangeable lenses” (P. 428).

1. Confirm that the **ON/OFF** lever is in the **OFF** position.

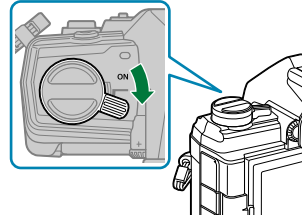

2. Remove the rear cap of the lens and the body cap of the camera.

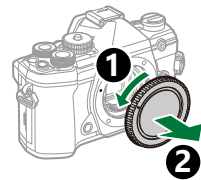
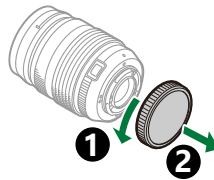

3. Align the lens attachment mark (red) on the camera with the alignment mark (red) on the lens, then insert the lens into the camera's body.

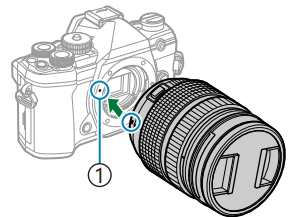

① Lens attachment mark

4. Rotate the lens clockwise until it clicks into place.

- ⚠ Do not press the lens release button.
- ⚠ Do not touch internal portions of the camera.

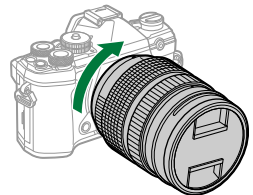

5. Remove the front lens cap.

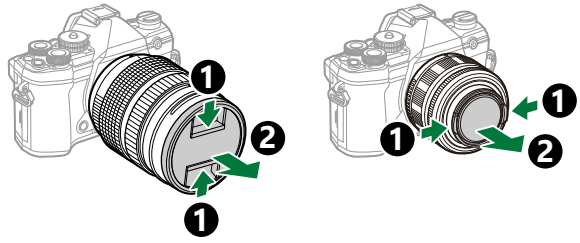

Removing Lenses

1. Confirm that the **ON/OFF** lever is in the **OFF** position.

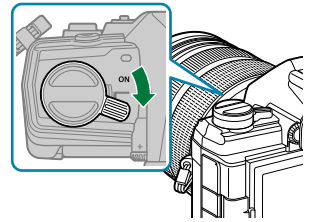

2. Hold the lens release button and rotate the lens as shown.

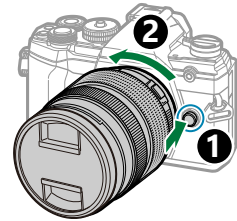

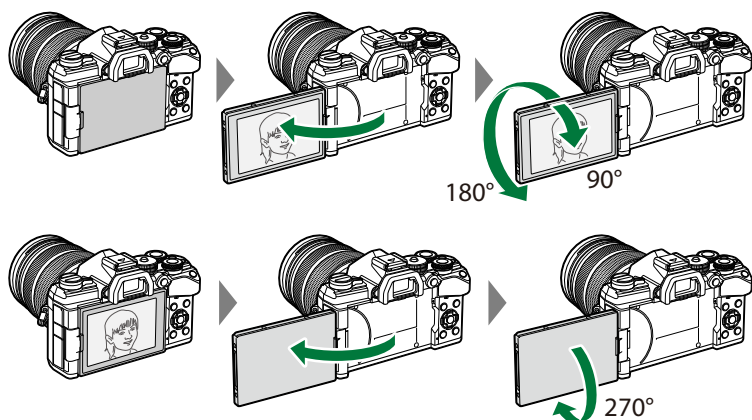

Using the monitor

Rotate the monitor for ease of viewing. The angle of the monitor can be adjusted according to conditions at the time of shooting.

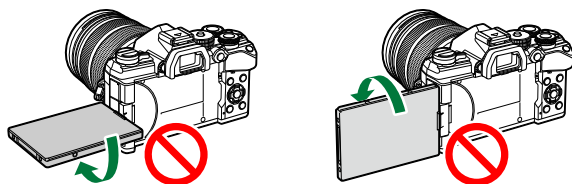

- Gently rotate the monitor within its range of motion. Attempting to rotate the monitor beyond the limits shown below could damage the connectors.



- The camera can be configured to display a mirror image of the view through the lens or automatically zoom power zoom lenses all the way out when the monitor is rotated for self portraits.  ["Selfie Assist \(Selfie Assist\)"](#) (P. 336)

Turning the camera on

1. Set the **ON/OFF** lever to the **ON** position.

- When the camera is turned on, the monitor will turn on.
- To turn the camera off, return the lever to the **OFF** position.

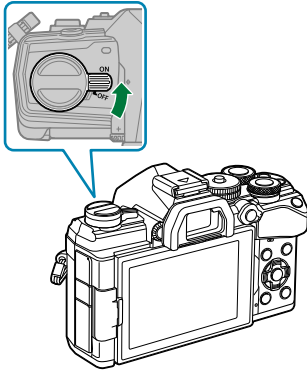

Battery level

Battery icon and battery level are displayed.

▣ (green): The camera is ready to shoot.

▣ (green): The battery is not full.

▣ (green): The battery is low.





▣ (blinks red): Charge the battery.



🔊 The **Fn** lever can be configured to turn the camera on and off. 🖱️ ⚙️ **Custom Menu B** > **[Fn Lever/Power Lever]** (P. 275)

Sleep Mode

If no controls are used for a set period, the camera will automatically enter suspend operation to reduce the drain on the batteries. This is referred to as “sleep mode”.

- When the camera enters sleep mode, the monitor will turn off and operation will be suspended. Pressing the shutter or  button reactivates the camera.
 - If no operations are performed for a set period after the camera enters sleep mode, the camera will turn off automatically. The camera can be reactivated by turning it on again.
- ⓘ The camera may require additional time to recover from sleep mode when **[On]** (enabled) is selected for **[Wi-Fi/Bluetooth Settings] > [Power-off Standby]**.  [“Wireless Settings for When the Camera Is Off” \(P. 362\)](#)
- ⓘ The delay before the camera goes to sleep or turns off automatically can be selected in the  Custom Menu. At default settings, the camera will go to sleep after one minute and turn off automatically after four hours.   [Custom Menu **\[2\]** > \[Sleep\], \[Auto Power Off\]](#) (P. 296)

Initial setup

After turning the camera on for the first time, perform the initial setup by choosing a language and setting the camera clock.

- ⓘ The file name is also included with the date and time information. Be sure to set the correct date and time before using the camera. Some functions cannot be used if the date and time have not been set.

1. Press the **OK** button when the initial setup dialog is displayed prompting you to choose a language.

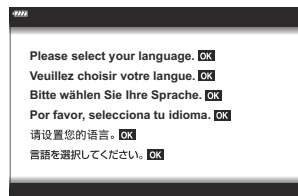

2. Highlight the desired language using the front or rear dial or the Δ ∇ \triangleleft \triangleright buttons.



3. Press the **OK** button when the desired language is highlighted.



- If you press the shutter button before pressing the **OK** button, the camera will exit to shooting mode and no language will be selected. You can perform the initial setup by turning the camera off and then on again to display the initial setup dialog and repeating the process from Step 1.
- The language can be changed at any time from the menu. 📖 "What to Do if You Can't Read the Display" (P. 36)

4. Set the date, time, and date format.

- Use the ◀▶ buttons to highlight items.
- Use the ▲▼ buttons to change the highlighted item.
- The time is displayed using a 24-hour clock.

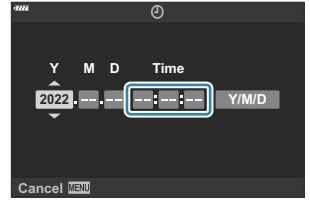

- The clock can be adjusted at any time from the menu. 🖱️ [▶ Setup Menu > \[⌚ Settings\]](#) (P. 262)

5. Press the **OK** button.

6. Highlight a time zone using the ▲▼ buttons and press the **OK** button.

- Press the **INFO** button to enable or disable daylight saving time.

7. Press the **OK** button to set the clock.

🌀 Date and time information is recorded on the card together with the images.

🌀 If the battery is removed from the camera and the camera is left for a while, the date and time may be reset. If this happens, set the date and time using the menu. 🖱️ [▶ Setup Menu > \[⌚ Settings\]](#) (P. 262)

🌀 You may also need to adjust the frame rate before shooting movies. 🖱️ “[Frame Size, Rate, and Compression \(📷 ⚙️\)](#)” (P. 141)

What to Do If You Can't Read the Display

If you see unfamiliar characters or words in other languages, you may not have selected the language you intended. Follow the steps below to choose another language.

1. Press the **MENU** button to view the menus.

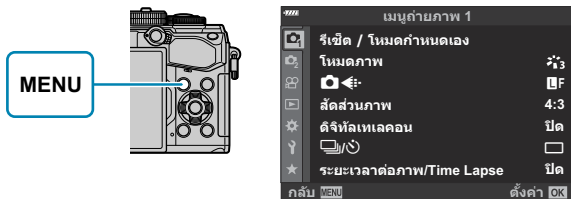

2. Highlight the **Y** (setup) tab using the Δ ∇ buttons and press the **OK** button.

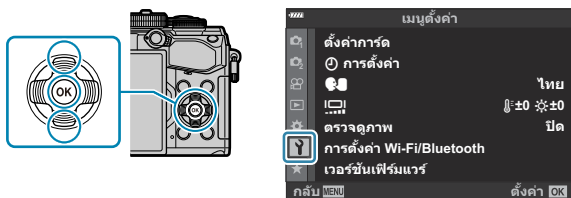

3. Highlight [**🇹🇹**] using the Δ ∇ buttons and press the **OK** button.

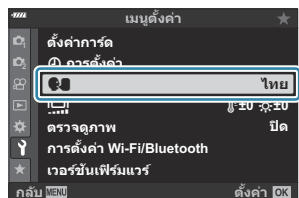

4. Highlight the desired language using the Δ ∇ \triangleleft \triangleright buttons and press the **OK** button.



Shooting



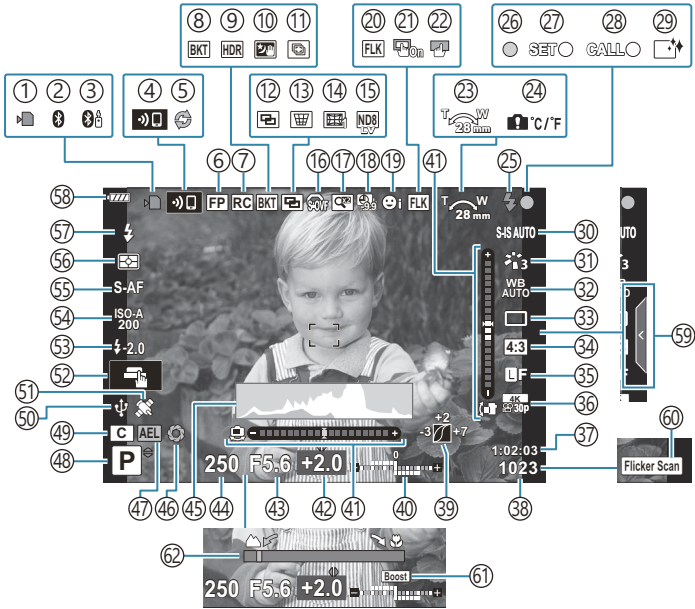

Information displays while shooting

Monitor display during still photography

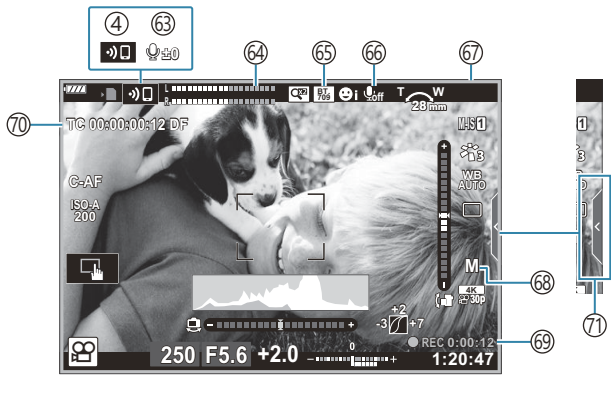







Monitor display during movie mode



- ① Card write indicator (P. 23, P. 28)
- ② Active **Bluetooth**® connection (P. 359)
- ③ Active connection to remote control (P. 377)
- ④ Wireless LAN connection (P. 359)
- ⑤ Pro Capture active (P. 107)
- ⑥ Super FP flash (P. 432)
- ⑦ RC mode (P. 434)
- ⑧ Bracketing (P. 216)
- ⑨ HDR (P. 224)
- ⑩ Handheld starlight (P. 68)
- ⑪ Multi focus shot (P. 68)
- ⑫ Multiple exposure (P. 227)
- ⑬  Keystone compensation (P. 230)
- ⑭ Fisheye Compensation (P. 353)
- ⑮ Live ND shooting (P. 213)
- ⑯  S-OVF ¹ (P. 169, P. 176)
- ⑰ Digital tele-converter (P. 208)
- ⑱ Time lapse shooting (P. 209)
- ⑲ Face priority/Eye priority (P. 126)
- ⑳ Anti-flicker shooting (P. 325)
- ㉑ AF Targeting Pad
 -   Custom Menu **A3** > **[AF Targeting Pad]** (P. 273)
- ㉒ Touch screen lock (P. 169)
- ㉓ Zoom operation direction/focal length
- ㉔ Internal temperature warning (P. 450)
- ㉕ Flash (blinks: charging in progress, lights up: charging completed) (P. 147)
- ㉖ AF confirmation mark (P. 43)
- ㉗ SET Function (P. 430)
- ㉘ CALL Function (P. 430)
- ㉙ Dust reduction (P. 444)
- ㉚ Image stabilizer (P. 134)
- ㉛ Picture Mode (P. 154, P. 206)
- ㉜ White balance (P. 129)
- ㉝ Drive mode (single-frame/sequential shooting/self-timer/vibration reduction/silent photography/Pro Capture/High Res Shot) (P. 101, P. 137)
- ㉞ Aspect ratio (P. 138)
- ㉟ Image quality (photos) (P. 139, P. 207)
- ㊱ Record mode (movies) (P. 141, P. 242)
- ㊲ Available recording time (P. 424)
- ㊳ Number of storable still pictures (P. 422)
- ㊴ Highlight & shadow control (P. 166)
- ㊵ Top: Flash intensity control (P. 153)
Bottom: Exposure compensation (P. 89)
- ㊶ Level gauge (P. 42)
- ㊷ Exposure compensation value (P. 89)
- ㊸ Aperture value (P. 48, P. 51, P. 53, P. 55)
- ㊹ Shutter speed (P. 48, P. 51, P. 53, P. 55)
- ㊺ Histogram (P. 42)
- ㊻ Preview (P. 167)
- ㊼ AE lock (P. 100, P. 299)
- ㊽ Shooting mode (P. 43)
- ㊾ Custom mode (P. 79, P. 77)
- ㊿ Active connection to webcam (P. 374)
- 1 **Bluetooth** location tracking active (P. 374)
- 2 Touch operation (P. 46)
- 3 Flash intensity control (P. 153)
- 4 ISO sensitivity (P. 98, P. 117)
- 5 AF mode (P. 118)
- 6 Metering mode (P. 124)
- 7 Flash mode (P. 147, P. 149)
- 8 Battery level (P. 32)
- 9 Live guide recall (P. 64)
- 0 Flicker scan (P. 240, P. 343)
- 1 Live view boost (P. 280)
- 2 Focus distance indicator (P. 317)

1 Shown in viewfinder only.

- ⑥3 Audio recording level ² (P. 84, P. 246)
- ⑥4 Recording level meter (P. 246)
- ⑥5  View assist
 -  Video Menu > [ **Display Settings**](P. 233)
- ⑥6 Movie sound (P. 246)
- ⑥7 Recording indicator (red border)
 -  Video Menu > [**Red Frame during**
 -  **REC]** (P. 233)
- ⑥8 Movie (exposure) mode (P. 238)
- ⑥9 Recording time (displayed during recording) (P. 83)
- ⑦0 Time code
 -  Video Menu > [ **HDMI Output**](P. 233)
- ⑦1 Silent control tab (P. 84)

2 Displayed only while audio recording level is being adjusted.

Switching between displays

The camera uses an eye sensor to automatically switch between the monitor and viewfinder displays. The monitor live view display and viewfinder also show information on camera settings. Options are available for controlling display switching and choosing the information shown.

Framing photos in the monitor

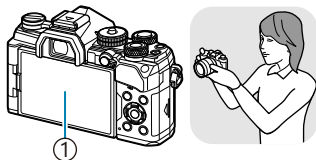

① Monitor



Live view is displayed on the monitor.

Framing photos in the viewfinder

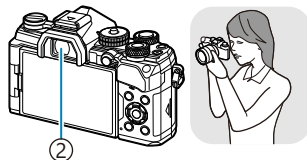

② Viewfinder



The viewfinder turns on automatically when you bring it to your eye. When the viewfinder is lit up, the monitor turns off.

- If the viewfinder is not in focus, put your eye to the viewfinder and focus the display by rotating the diopter adjustment dial.

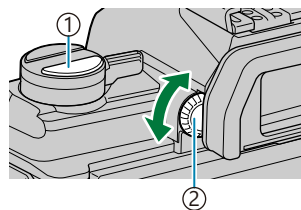

- ① **LV** button
- ② Diopter adjustment dial

- Pressing the **LV** button switches the display in the monitor from live view to the super control panel. Putting your eye to viewfinder displays the view through the lens. The monitor turns off.
- Shooting information can be viewed by pressing the **INFO** button when the super control panel is displayed (P. 41).

⚙️ Display switching and viewfinder display options are available in the camera menus.

👉 **Custom Menu** **1** > **[EVF Auto Switch], [EVF Style]** (P. 293)

Switching the information display

You can switch the information displayed in the monitor during shooting using the **INFO** button.

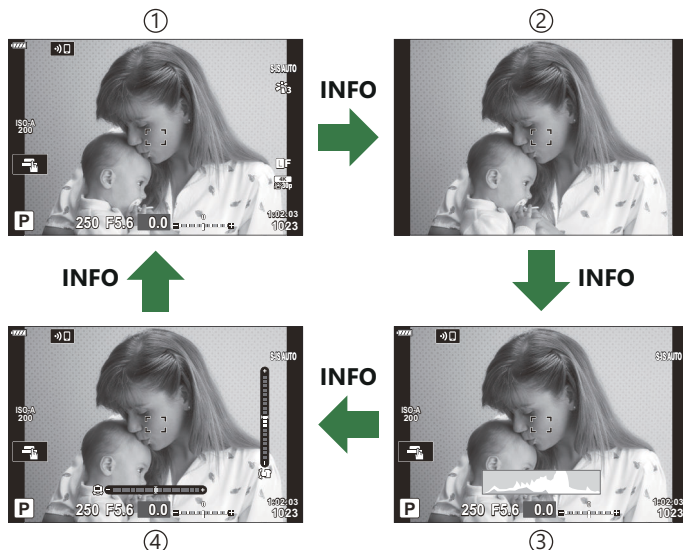
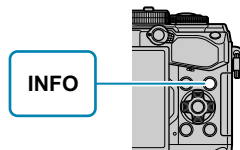

① Basic Information



② Image Only

③ Histogram display (Custom1)

④ Level Gauge display (Custom2)

- The information display screens can be switched in either direction by rotating the dial while pressing the **INFO** button.
- The items shown in the Custom 1 and Custom 2 displays can be chosen using **[INFO/Info Settings] > [LV-Info]** (P. 333).
- The information shown in movie (🎥) mode can differ from that displayed in still photography mode. **[Video Menu] > [Display Settings] > [Info Settings]** (P. 233)
- To choose the items displayed when the shutter button is pressed halfway, highlight **[Image Only]** in the **[LV-Info]** menu and press **▶**.



Histogram display

A histogram showing the distribution of brightness in the image is displayed. The horizontal axis gives the brightness, the vertical axis the number of pixels of each brightness in the image. Areas above the upper limit at shooting are displayed in red, those below the lower limit in blue, and those within the spot metering range in green. You can choose the upper and lower limits.   [Custom](#)

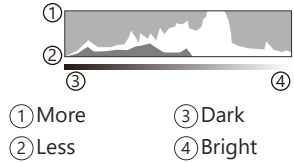
Menu  > [[Histogram Settings](#)] (P. 281)





Highlights and Shadows

Highlights and shadows, defined according to the upper and lower limits for the histogram display, are shown in red and blue. You can choose the upper and lower limits.   [Custom Menu](#)  > [[Histogram Settings](#)] (P. 281)

Level gauge display

The orientation of the camera is indicated. The “tilt” direction is indicated on the vertical bar and the “horizon” direction on the horizontal bar.

- The level gauge is intended as a guide only.
- Calibrate the gauge if you find it is no longer truly plumb or level.   [Custom Menu](#)  > [[Level Adjust](#)] (P. 295)

Shooting Information

Shooting information can be viewed by pressing the **INFO** button when the super control panel (P. 111) is displayed. Press the **INFO** button again to return to the super control panel.

- Shooting information can be hidden using the [[Info Settings](#)] > [[LV OFF-Info](#)] option in  [Custom Menu](#)  (P. 333).

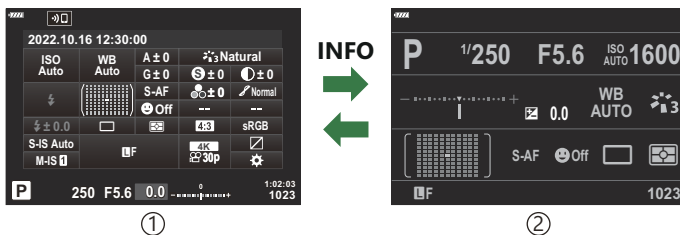

- ① Super control panel
- ② Shooting information

Shooting still pictures

Use the mode dial to select the shooting mode, and then shoot the image.

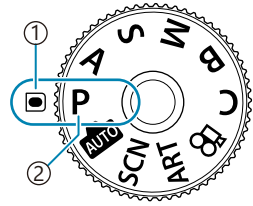



- ① Indicator
- ② Mode icon

Types of shooting modes

For how to use the various shooting modes, see the following.

P	Program AE (P. 48)
A	Aperture-priority AE (P. 51)
S	Shutter-priority AE (P. 53)
M	Manual exposure (P. 55)
B	Bulb/time (P. 58)
	Live composite (P. 62)
	AUTO (P. 64)
SCN	Scene (P. 67)
ART	Art filter (P. 74)
C	Custom (P. 79)

For information on the  position on the mode dial, see “Recording movies in movie mode ()” (P. 83).

1. Press the mode dial lock to unlock it, and then turn to set the mode you wish to use.

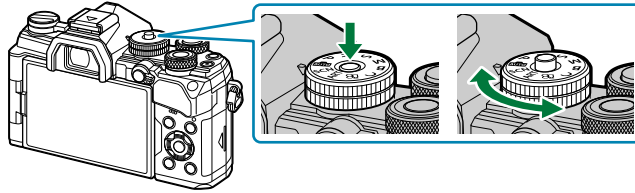

- When the mode dial lock has been pressed down, the mode dial is locked. Each time you press the mode dial lock, it switches between locked/released.

2. Frame the shot.

- ⓘ Be careful that your fingers or the camera strap do not obstruct the lens or AF illuminator.

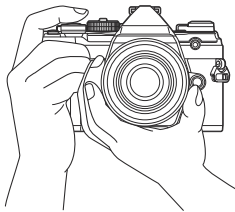

Landscape position

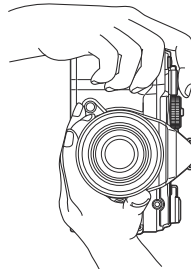

Portrait position

3. Adjust the focus.

- Position the AF frame over your subject.

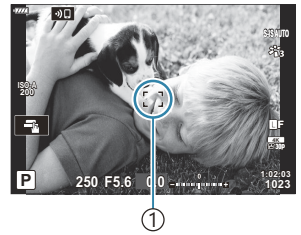

① AF frame

- Lightly press the shutter button down to the first position (press the shutter button halfway).
- The AF confirmation mark (●) will be displayed, and a green frame (AF target) will be displayed in the focus location.

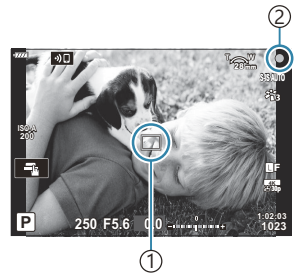

① AF target
② AF confirmation mark

- ⓘ If the camera is unable to focus, the AF confirmation mark will flash (P. 445).
- ⓘ The AF frame varies with the option chosen for AF-target mode. Change the area (P. 91) and position (P. 95) of the AF target as required.
- ⓘ The AF frame is not displayed when [ALL] is chosen for AF-target mode (P. 91).

4. Release the shutter.

- Press the shutter button all the way (fully).
- The camera will release the shutter and take a picture.









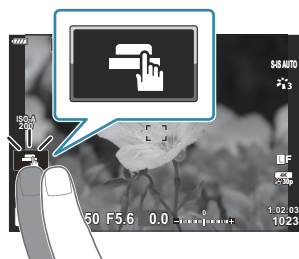





👉 You can focus and take pictures using touch controls. 👉 “Shooting with touch screen operations” (P. 46)

Shooting with touch screen operations

You can tap the subject to focus and take a photograph.



	Tap a subject to focus and automatically release the shutter. This option is not available in mode B (bulb), in  (movie) mode, or when [] AF] or [] AF ME] is selected for AF mode (P. 118).
	Shooting with touch screen operations is disabled.
	Tap to display an AF target and focus on the subject in the selected area. You can use the touch screen to choose the position and size of the focus frame. Photographs can be taken by pressing the shutter button.
	Tap to choose the subject used for focus when multiple portrait subjects are detected.  is displayed when an option other than [Off] is selected for [] Face Priority] (P. 126). Subject selection is not available when [] (high-speed movie recording) is selected for [] in  (movie) mode (P. 141).

- Tapping an icon switches the settings.

- ⚠ Do not touch the display with your fingernails or other sharp objects.
- ⚠ Gloves or monitor covers may interfere with touch screen operation.

Previewing the subject ()

1. Tap the subject in the display.

- An AF target will be displayed.
- Use the slider to choose the size of the frame.

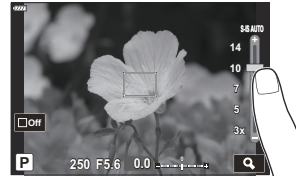

- Tap  to turn off the display of the AF target.

2. Use the slider to adjust the size of the AF target, and then tap to zoom in at the frame position.

- Use your finger to scroll the display when the picture is zoomed in.

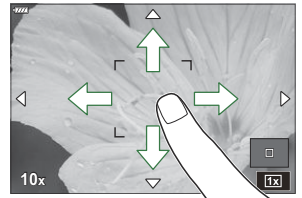

- Tap  to cancel the zoom display.

- The situations in which touch screen operations are not available include the following.
 - When buttons or dials are in use

- You can disable the touch screen operation.   Custom Menu  > [\[Touchscreen Settings\]](#) (P. 295)

Letting the camera choose aperture and shutter speed (P: Program AE)

The camera chooses the optimal aperture and shutter speed according to subject brightness.

1. Rotate the mode dial to **P**.

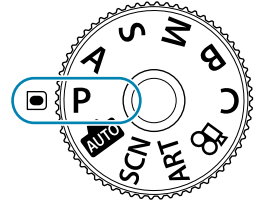



2. Focus and check the display.



- Use the front and rear dials to adjust the following settings.
Front dial: Exposure compensation (P. 89)
Rear dial: Program shift (P. 50)
- The shutter speed and aperture chosen by the camera are displayed.





- ① Exposure mode
- ② Shutter speed
- ③ Aperture

- Exposure compensation can also be adjusted using the  button. Press the  button and then rotate the front or rear dial.



3. Take pictures.

 You can choose the functions performed by the front and rear dials.  “Assigning Roles to the Front and Rear Dials ( Dial Function)” (P. 319)

 You can use the **Fn** lever to reverse the roles of the front and rear dials. The lever can also be assigned other roles.  “Customizing the Fn Lever ( Fn Lever Function)” (P. 321)

Subject Too Dark or Too Bright

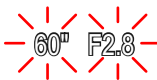
If the camera is unable to achieve optimal exposure, the shutter-speed and aperture displays will flash as shown.

Display	Problem/solution
Large aperture (low f/-number)/ slow shutter speed  60" F2.8	The subject is too dark. <ul style="list-style-type: none">• Use a flash.
Small aperture (high f/-number)/ fast shutter speed  8000 F22	The subject is too bright. <ul style="list-style-type: none">• The limits of the camera metering system have been exceeded. Use a third-party ND (Neutral Density) filter to reduce the amount of light entering the camera.• Shutter speeds as fast as 1/32000 s are available in [♥] (silent) mode.  "Shooting without shutter sound (Silent [♥])" (P. 106), "Performing the sequential/self-timer shooting" (P. 101)

 When [📷 ISO] is not set to [AUTO], optimal exposure may be achieved by changing the setting.

 ["Changing ISO sensitivity \(ISO\)"](#) (P. 98)

 The aperture value shown when the displays flash varies with the lens and focal length.



Program Shift

Without changing exposure, you can choose from different combinations of aperture and shutter speed selected automatically by the camera. This is known as program shift.

1. Rotate the rear dial until the camera displays the desired combination of aperture and shutter speed.
 - The shooting mode indicator in the display changes from **P** to **Ps** while program shift is in effect. To end program shift, rotate the rear dial in the opposite direction until only **P** is displayed.



① Program shift

 You can choose whether the display reflects the effects of exposure compensation or maintains a constant brightness for ease of viewing. At default settings, the display reflects the effects of exposure compensation.   Custom Menu **D2** > **[Live View Boost]** (P. 280)

Choosing aperture (A: Aperture-Priority AE)

In this mode, you choose the aperture (f/-number) and the camera automatically sets the shutter speed for optimal exposure according to subject brightness. Lower aperture values (larger apertures) reduce the depth of the area that appears to be in focus (depth of field), blurring the background. Higher aperture values (smaller apertures) increase the depth of the area that appears to be in focus in front of and behind the subject.



① Lower aperture values...

...reduce depth of field and increase blur.

② Higher aperture values...

...increase depth of field.

1. Rotate the mode dial to **A**.

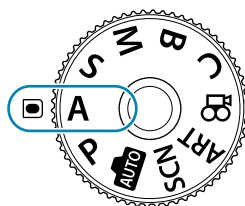



2. Choose an aperture.



- Use the front and rear dials to adjust the following settings.
Front dial: Exposure compensation (P. 89)
Rear dial: Aperture



① Aperture

- The shutter speed selected automatically by the camera will appear in the display.
- Exposure compensation can also be adjusted using the  button. Press the  button and then rotate the front or rear dial.



3. Take pictures.

 You can choose the functions performed by the front and rear dials.  “Assigning Roles to the Front and Rear Dials ( Dial Function)” (P. 319)

- ☞ You can use the **Fn** lever to reverse the roles of the front and rear dials. The lever can also be assigned other roles. 📖 [“Customizing the Fn Lever \(Fn Lever Function\)”](#) (P. 321)
- ☞ You can choose whether the display reflects the effects of exposure compensation or maintains a constant brightness for ease of viewing. At default settings, the display reflects the effects of exposure compensation. 📖 [Custom Menu D2 > \[Live View Boost\]](#) (P. 280)
- ☞ You can stop aperture down to the selected value and preview depth of field. 📖 [“Assigning functions to buttons \(Button Function\)”](#) (P. 167)

Subject Too Dark or Too Bright

If the camera is unable to achieve optimal exposure, the shutter-speed display will flash as shown.

Display	Problem/solution
Slow shutter speed 	Underexposure. <ul style="list-style-type: none"> • Choose a lower aperture value.
Fast shutter speed 	Overexposure. <ul style="list-style-type: none"> • Choose a higher aperture value. • If the subject is still overexposed at the higher value, the limits of the camera metering system have been exceeded. Use a third-party ND (Neutral Density) filter to reduce the amount of light entering the camera. • Shutter speeds as fast as 1/32000 s are available in [♥] (silent) mode. 📖 “Shooting without shutter sound (Silent [♥])” (P. 106), “Performing the sequential/self-timer shooting” (P. 101)

- ☞ When [ISO] is not set to [AUTO], optimal exposure may be achieved by changing the setting. 📖 [“Changing ISO sensitivity \(ISO\)”](#) (P. 98)

Choosing shutter speed (S: Shutter-Priority AE)

In this mode, you choose the shutter speed and the camera automatically sets aperture for optimal exposure according to subject brightness. Faster shutter speeds appear to “freeze” fast-moving subjects. Slower shutter speeds add blur to moving objects, lending them a sense of motion for a dynamic effect.

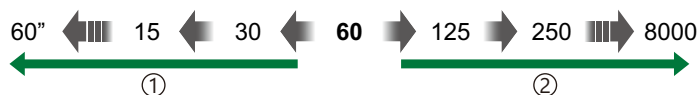

① Slower shutter speeds...

...produce dynamic shots with a sense of motion.

② Faster shutter speeds...

...“freeze” the motion of fast-moving subjects.

1. Rotate the mode dial to **S**.

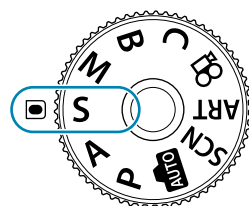

2. Choose a shutter speed.

- Use the front and rear dials to adjust the following settings.

Front dial: Exposure compensation (P. 89)

Rear dial: Shutter speed

- Choose from shutter speeds of 1/8000–60 s.
- Shutter speeds as fast as 1/32000 s are available in silent mode. “Shooting without shutter sound (Silent [♥])” (P. 106), “Performing the sequential/self-timer shooting” (P. 101)
- The aperture selected automatically by the camera will appear in the display.
- Exposure compensation can also be adjusted using the button. Press the button and then rotate the front or rear dial.





① Shutter speed

3. Take pictures.

- ☞ You can choose the functions performed by the front and rear dials. 📖 “Assigning Roles to the Front and Rear Dials (📷 Dial Function)” (P. 319)
- ☞ You can use the **Fn** lever to reverse the roles of the front and rear dials. The lever can also be assigned other roles. 📖 “Customizing the Fn Lever (📷 Fn Lever Function)” (P. 321)
- ☞ You can choose whether the display reflects the effects of exposure compensation or maintains a constant brightness for ease of viewing. At default settings, the display reflects the effects of exposure compensation. 📖 ⚙️ Custom Menu **D2** > **[Live View Boost]** (P. 280)
- ☞ To achieve the effect of a slow shutter in brightly-lit settings in which slow shutter speeds are not otherwise available, use the live ND filter. 📖 “Slowing the Shutter in Bright Light (Live ND Shooting)” (P. 213)
- ☞ Depending on the shutter speed selected, you may notice banding in the display caused by flicker from fluorescent or LED light sources. The camera can be configured to reduce the effects of flicker during live view or when pictures are taken. 📖 “Reducing Flicker in Photographs (Anti-Flicker Shooting)” (P. 327), “Reducing Flicker Under LED Lighting (📷 Flicker Scan)” (P. 343)

Subject Too Dark or Too Bright

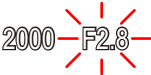
If the camera is unable to achieve optimal exposure, the aperture display will flash as shown.

Display	Problem/solution
Low aperture value 	Underexposure. <ul style="list-style-type: none"> Choose a slower shutter speed.
High aperture value 	Overexposure. <ul style="list-style-type: none"> Choose a faster shutter speed. Shutter speeds as fast as 1/32000 s are available in silent mode. If the subject is still overexposed at the higher speed, the limits of the camera metering system have been exceeded. Use a third-party ND (Neutral Density) filter to reduce the amount of light entering the camera.

- ☞ When **[ISO]** is not set to **[AUTO]**, optimal exposure may be achieved by changing the setting. 📖 “Changing ISO sensitivity (ISO)” (P. 98)
- ☞ The aperture value shown when the displays flash varies with the lens and focal length.

Choosing aperture and shutter speed (M: Manual Exposure)

In this mode, you choose the aperture and shutter speed. You can adjust settings according to your goals, for example by combining fast shutter speeds with small apertures (high f/-numbers) for increased depth of field.

1. Rotate the mode dial to **M**.

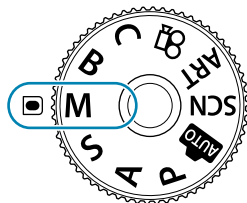

2. Adjust aperture and shutter speed.

- Use the front and rear dials to adjust the following settings.
Front dial: Aperture
Rear dial: Shutter speed
- Shutter speed can be set to values between 1/8000 and 60 s.
- Shutter speeds as fast as 1/32000 s are available in silent mode. “Shooting without shutter sound (Silent [♥])” (P. 106)
- The display shows the difference between the exposure produced by the selected aperture and shutter speed and the optimal exposure metered by the camera. The display will flash if the difference exceeds ± 3 EV.



① Difference from optimal exposure



- When **[AUTO]** is selected for **ISO**, ISO sensitivity will automatically be adjusted for optimal exposure at the selected exposure settings. **ISO** defaults to **[AUTO]**.
 “Changing ISO sensitivity (ISO)” (P. 98)

3. Take pictures.



- ☞ You can choose the functions performed by the front and rear dials. ☞ [“Assigning Roles to the Front and Rear Dials \(📷 Dial Function\)” \(P. 319\)](#)
- ☞ You can use the **Fn** lever to reverse the roles of the front and rear dials. The lever can also be assigned other roles. ☞ [“Customizing the Fn Lever \(📷 Fn Lever Function\)” \(P. 321\)](#)
- ☞ You can choose whether the display reflects the effects of exposure compensation or maintains a constant brightness for ease of viewing. At default settings, the display reflects the effects of exposure compensation. ☞ [🔧 Custom Menu **D2** > \[Live View Boost\] \(P. 280\)](#)
- ☞ Depending on the shutter speed selected, you may notice banding in the display caused by flicker from fluorescent or LED light sources. The camera can be configured to reduce the effects of flicker during live view or when pictures are taken. ☞ [“Reducing Flicker in Photographs \(Anti-Flicker Shooting\)” \(P. 327\)](#), [“Reducing Flicker Under LED Lighting \(📷 Flicker Scan\)” \(P. 343\)](#)

Subject Too Dark or Too Bright

If the camera is unable to achieve optimal exposure with **[AUTO]** selected for **[📷 ISO]**, the ISO sensitivity display will flash as shown.

Display	Problem/solution
	<p>Overexposure.</p> <ul style="list-style-type: none"> Choose a higher aperture value or faster shutter speed.
	<p>Underexposure.</p> <ul style="list-style-type: none"> Choose a lower aperture value or slower shutter speed. If the warning does not clear from the display, choose a higher value for ISO sensitivity. ☞ “Changing ISO sensitivity (ISO)” (P. 98), 🔧 Custom Menu E1 [📷 ISO-Auto Set] > [Upper Limit / Default] (P. 284)

Using Exposure Compensation in Mode M

In mode **M**, exposure compensation is available when **[AUTO]** is selected for **[ISO ISO]**. Because exposure compensation is performed by adjusting ISO sensitivity, aperture and shutter speed are not affected.  “Changing ISO sensitivity (ISO)” (P. 98),  Custom Menu  **[ISO-Auto Set]** > **[Upper Limit / Default]** (P. 284)

1. Hold the  button and rotate the front or rear dial.
 - Exposure compensation is added to the exposure difference shown in the display.



- ① Exposure compensation
- ② Exposure compensation plus exposure difference

Long Exposures (B: Bulb/Time)

Select this mode to leave the shutter open for a long exposure. You can preview the photo in live view and end the exposure when the desired results have been achieved. Use when long exposures are required, for example when photographing night scenes or fireworks.

🔔 We recommend that the camera be securely fixed to a tripod for long exposures.

“Bulb” and “Live Bulb” Photography

The shutter remains open while the shutter button is pressed. Releasing the button ends the exposure.

- The amount of light entering the camera increases the longer the shutter is open.
- When live bulb photography is selected, you can check the results in the live view display and end exposure when you want to.

“Time” and “Live Time” Photography

The exposure begins when the shutter button is pressed all the way down. To end the exposure, press the shutter button all the way down a second time.

- The amount of light entering the camera increases the longer the shutter is open.
- When live time photography is selected, you can check the results in the live view display and end exposure when you want to.

Bulb/Time Photography

1. Rotate the mode dial to **B**.

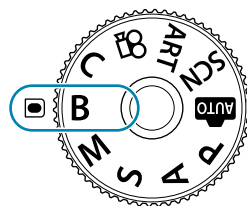

2. Select **[BULB]** (for bulb photography) or **[TIME]** (time photography).
- At default settings, the selection is made with the rear dial.

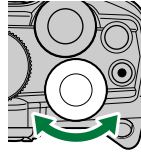

① Bulb or time photography

3. Press the **MENU** button.
- You will be prompted to choose the interval at which the preview is updated.

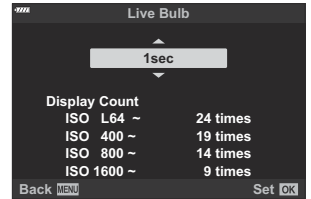

4. Highlight an interval using $\Delta \nabla$.

5. Press the **OK** button to select the highlighted option.
- The menus will be displayed.





6. Press the **MENU** button repeatedly to exit the menu.
- If an option other than **[Off]** is selected, **[LIVE BULB]** or **[LIVE TIME]** will appear in the display.











7. Adjust aperture.
- At default settings, aperture can be adjusted using the front dial.



① Aperture

8. Take pictures.

- In bulb and live bulb modes, keep the shutter button pressed. The exposure ends when the button is released.
- In time and live time modes, press the shutter button all the way down once to start the exposure and again to end it.
- During live time photography, you can refresh the preview by pressing the shutter button halfway.
- The exposure ends automatically when the time selected for **[Bulb/Time Timer]** is reached.   Custom Menu **E2** > **[Bulb/Time Timer]** (P. 285)
- **[Noise Reduct.]** is applied after shooting. The display shows the time remaining until the process is complete. You can choose the conditions under which noise reduction is performed.   Custom Menu **E1** > **[Noise Reduct.]** (P. 284)

- ⚠ Some limitations apply to the choice of ISO sensitivity settings available.
- ⚠ Bulb photography is used in place of live bulb photography when multiple exposure, keystone compensation, or fisheye correction is in effect.
- ⚠ Time photography is used in place of live time photography when multiple exposure, keystone compensation, or fisheye correction is in effect.
- ⚠ During shooting, there are limits on the settings for the following functions.
 - Sequential shooting, self-timer shooting, interval timer photography, AE bracketing, flash bracketing, focus bracketing, focus stacking, etc.
- ⚠  **[Image Stabilizer]** (P. 134) turns off automatically.
- ⚠ Depending on camera settings, the temperature, and the situation, you may notice noise or bright spots in the monitor. These may sometimes appear in pictures even when **[Noise Reduct.]** is enabled.   Custom Menu **E1** > **[Noise Reduct.]** (P. 284)
- 👉 Starry sky AF can be used for shots of the night sky.  "Choosing a focus mode (AF Mode) (P. 118), "Using Starry Sky AF" (P. 121)
- 👉 Display brightness can be adjusted during bulb/time photography.   Custom Menu **E2** > **[Bulb/Time Monitor]** (P. 285)
- 👉 During bulb/time photography, display brightness is adjusted to make even poorly-lit subjects easy to see. You can choose whether to prioritize image quality or display speed.   Custom Menu **D2** > **[Live View Boost]** (P. 280)
- 👉 In mode **B** (bulb), you can adjust focus manually while the exposure is in progress. This allows you to defocus during the exposure or focus at the end of the exposure.   Custom Menu **A4** > **[Bulb/Time Focusing]** (P. 318)

Noise

While shooting at slow shutter speeds, noise may appear on screen. These phenomena occur when the temperature rises in the image sensor or image sensor internal drive circuit, causing current to be generated in those sections of the image sensor that are not normally exposed to light. This can also occur when shooting with a high ISO setting in a high-temperature environment. To reduce this noise, the camera activates the noise reduction function.

  Custom Menu  > **[Noise Reduct.]** (P. 284)

Lighten Blending (B: Live Composite Photography)

Leave the shutter open for a long exposure. You can view the light trails left by fireworks or stars and photograph them without changing the exposure of the background. The camera combines multiple shots and records them as a single photograph.

① We recommend that the camera be securely fixed to a tripod for live composite photography.

1. Rotate the mode dial to **B**.

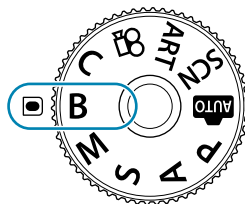

2. Select **[LIVE COMP]**.

- At default settings, the selection is made with the rear dial.



① Live composite photography

3. Press the **MENU** button.

- The **[Composite Settings]** menu will be displayed.



4. Highlight an exposure time using Δ ∇ .

- Choose an exposure time of from 1/2 to 60 s.

5. Press the **OK** button to select the highlighted option.

- The menus will be displayed.

6. Press the **MENU** button repeatedly to exit the menu.
7. Adjust aperture.
 - At default settings, aperture can be adjusted using the front dial.
8. Press the shutter button all the way down to ready the camera.
 - The camera is ready to shoot when **[Ready for composite shooting]** is displayed.



9. Press the shutter button to start shooting.
 - Live composite photography will start. The display will be updated after each exposure.
10. Press the shutter button again to end shooting.
 - Shooting ends automatically after the time selected for **[Live Composite Timer]**. Other options can be selected. **Custom Menu E2 > [Live Composite Timer]** (P. 285)
 - The maximum recording time available varies with battery level and shooting conditions.

Some limitations apply to the choice of ISO sensitivity settings available.

The following cannot be used:

- sequential shooting, the self-timer, interval-timer photography, AE bracketing, flash bracketing, focus bracketing, HDR photography, High Res Shot, focus stacking, multiple exposure, keystone compensation, the live ND filter, and fisheye correction.

[Image Stabilizer] (P. 134) turns off automatically.

Starry sky AF can be used for shots of the night sky. **"Choosing a focus mode (AF Mode)** (P. 118), **"Using Starry Sky AF"** (P. 121)

Display brightness can be adjusted during live composite photography. **Custom Menu E2 > [Bulb/Time Monitor]** (P. 285)

The exposure time for each exposure made during live composite photography can be chosen in advance using the menus. **Custom Menu E2 > [Composite Settings]** (P. 285)

Letting the camera choose the settings (AUTO mode)

The camera adjusts settings to suit the scene; all you have to do is press the shutter button. Use live guides to easily adjust such parameters as color, brightness, and background blurring.

1. Rotate the mode dial to .

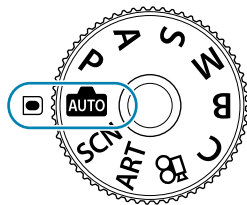

- In auto mode, the camera automatically selects the scene mode option appropriate to your subject when you press the shutter button halfway. Once the selection has been made, the  icon in the bottom left corner of the display will be replaced by the icon for the chosen scene.

2. To adjust shooting settings, display the live guide by pressing the **OK** button.

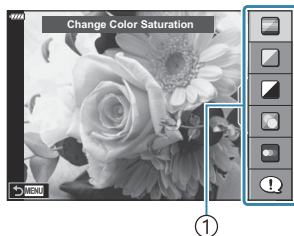

① Guide item

- Use Δ ∇ to highlight an item in the live guide and press **OK** to display a slider.

3. Use Δ ∇ to position the slider and choose a level.



① Slider

- Press the **OK** button to save changes.
- To exit, press the **MENU** button.
- When [**Shooting Tips**] is selected, use Δ ∇ to highlight the item and press the **OK** button to display the detail.
- The effect of the selected level is visible in the display.
If [**Blur Background**] or [**Express Motions**] is selected, the display will return to normal, but the selected effect will be visible in the final photograph.

4. To set multiple live guides, repeat Steps 2 and 3.



- A check is displayed on the guide item for live guides that are already set.
- To clear the live guides from the display, press the **MENU** button.

ⓘ [**Blur Background**] and [**Express Motions**] cannot be set at the same time.

5. Take pictures.

👉 Live guide settings can also be adjusted using touch controls.

👉 If [**RAW**] is currently selected for image quality, image quality will automatically be set to RAW+JPEG.

- ⓘ Live guide settings are not applied to the RAW copy.
- ⓘ Pictures may appear grainy at some live guide setting levels.
- ⓘ Changes to live guide setting levels may not be visible in the monitor.
- ⓘ Frame rates drop the closer the [**Express Motions**] slider is to [**Blurred Motion**].
- ⓘ The flash cannot be used when a live guide is set.

⚠ Choosing live guide settings that exceed the limits of the camera exposure meters may result in pictures that are overexposed or underexposed.

Shooting in scene mode (SCN mode)

The camera automatically optimizes settings for the subject or scene.

1. Rotate the mode dial to **SCN**.

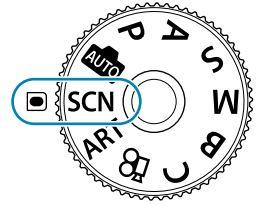

2. Use Δ ∇ \triangleleft \triangleright to highlight a scene and press the **OK** button.





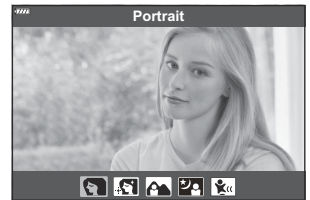

3. Use \triangleleft \triangleright to highlight a scene mode and press the **OK** button.







4. Take pictures.
 - To choose a different scene, press the **OK** button. Next, press the **MENU** button to return to the scene-selection display.

Types of scene modes

People



	Portrait	Suitable for portrait shooting. Brings out skin texture.
	e-Portrait	Smooths out skin tones and texture. The camera records two pictures: one with the effect applied and one without.
	Portrait + Landscape	Suitable for portraits featuring a landscape in the background. Blues, greens, and skin tones are captured beautifully.
	Portrait + Nightscape	Suitable for portrait shooting against a background of night view. Attach an external flash unit designed for use with the camera (P. 147). We recommend that you use a tripod and either OM Image Share or an optional remote control (P. 366, P. 380).
	Children	Suitable for photographs of children and other active subjects.

Nightscapes





	Nightscape	Suitable for tripod shooting of night scenes. We recommend that you use a tripod and either OM Image Share or an optional remote control (P. 366, P. 380).
	Portrait + Nightscape	Suitable for portrait shooting against a background of night view. Attach an external flash unit designed for use with the camera (P. 147). We recommend that you use a tripod and either OM Image Share or an optional remote control (P. 366, P. 380).
	Handheld Starlight	Suitable for shooting night scenes without a tripod. Reduces blur when shooting low light/illuminated scenes. The camera makes eight exposures and combines them into a single photograph.
	Fireworks	Suitable for shooting fireworks at night. We recommend that you use a tripod and either OM Image Share or an optional remote control (P. 366, P. 380).

	Light Trails	<p>The camera automatically shoots multiple images, takes newly bright areas only, and composites them into a single image. With normal long exposure, an image of light trace such as star trails with bright buildings tends to get too bright. You can capture them without over exposure while checking the progress. Press the shutter button to start shooting, then view the changing result in the monitor and press the shutter button again to end shooting once the desired result is achieved (maximum 3 hours). We recommend that you use a tripod and either OM Image Share or an optional remote control (P. 366, P. 380).</p> <ul style="list-style-type: none"> Advanced settings can be accessed via live composite photography (dark and light field composite) in mode B (P. 62)
--	---------------------	--

Motion







	Sport	<p>Suitable for fast action shooting. The camera will take photos while the shutter button is pressed.</p>
	Children	<p>Suitable for photographs of children and other active subjects.</p>
	Panning	<p>Choose to blur the background behind moving objects. The camera chooses the optimal shutter speed for panning shots based on camera motion.</p>

Scenery





	Landscape	<p>Suitable for landscape shooting.</p>
	Sunset	<p>Suitable for shooting the sunset.</p>
	Beach & Snow	<p>Suitable for shooting at snow-capped mountains, seascapes in the sun, and other whitish scenes.</p>
	Panorama	<p>Take photos that can afterwards be joined on a computer to create a panorama.</p> <ul style="list-style-type: none"> For information on taking photos using this feature, see “Shooting a Panorama” (P. 71).



	Backlight HDR	Suitable for high-contrast scenes. Each time the shutter button is pressed, the camera takes four shots that are automatically combined to form a single, correctly exposed image when shooting is complete.
--	----------------------	--

Indoors

	Candlelight	Suitable for shots of candlelit scenes. Warm colors are preserved.
	Silent [♥]	Disable camera sounds and lights in situations in which they may be unwelcome.
	Portrait	Suitable for portrait shooting. Brings out skin texture.
	e-Portrait	Smooths out skin tones and texture. The camera records two pictures: one with the effect applied and one without.
	Children	Suitable for photographs of children and other active subjects.
	Backlight HDR	Suitable for high-contrast scenes. Each time the shutter button is pressed, the camera takes four shots that are automatically combined to form a single, correctly exposed image when shooting is complete.

Close-ups

	Macro	Suitable for close-ups.
	Nature Macro	Suitable for vivid close-ups of flowers or insects.
	Documents	Suitable for photos of timetables or other documents. The camera heightens the contrast between the text and background.
	Multi Focus Shot	The camera takes eight photos, varying the focus distance with each shot.

 In **[Panning]**,  is displayed during panning detection, and  is displayed when nothing is detected.

 To maximize the benefits of the scene modes, some of the shooting function settings are disabled.

- ⓘ Some time may be needed to record pictures taken using **[e-Portrait]**. In addition, when the image quality mode is **[RAW]**, the image is recorded in RAW+JPEG.
- ⓘ Movies cannot be recorded using **[e-Portrait]**, **[Handheld Starlight]**, **[Panorama]**, or **[Backlight HDR]**.
- ⓘ Movie recording is not available in **[Light Trails]** mode when **FRD HS 60p** (high-speed movie recording) is selected for **[⏏ ⏪]**.
- ⓘ **[Handheld Starlight]** pictures taken with **[RAW]** selected for image quality will be recorded in RAW+JPEG format, with the first frame recorded as a RAW image and the final composite as a JPEG image.
- ⓘ **[Backlight HDR]** records HDR-processed images in JPEG format. When the image quality mode is set to **[RAW]**, the image is recorded in RAW+JPEG.
- ⓘ When using a lens with an image stabilizer switch in **[Panning]**, turn the image stabilizer switch off. Sufficient panning effects may not be obtained in bright conditions. Use a commercially available ND filter to obtain effects more easily.
- ⓘ Shooting will end if zoom is adjusted while photographs are being taken in **[Multi Focus Shot]** mode.
- ⓘ No pictures can be taken in **[Multi Focus Shot]** mode when a Four-Thirds lens is attached.

Shooting a Panorama

Pictures taken using this option can be joined together to form a panorama. You will need to install the latest version of OM Workspace on your computer to join pictures together to form a panorama.

👉 ["Installing the PC software" \(P. 373\)](#)

1. Highlight **[Panorama]** in the scene mode menu (P. 67) and press the **OK** button.
2. Use **△ ▽ ◀ ▶** to choose a pan direction.
3. Take a picture, using the guides to frame the shot.
 - Focus, exposure, and other settings are fixed at the values for the first shot.



4. Take the remaining images, framing each shot so that the guides overlap with the previous picture.



- A panorama may include up to 10 images. A warning indicator (🔔) is displayed after the tenth shot.
- ⓘ During panorama shooting, the image previously taken for position alignment will not be displayed. With the frames or other markers for display in the images as a guide, set the composition such that the edges of the overlapping images overlap within the frames.

5. After taking the last shot, press **OK** to end the series.

Using art filters (ART mode)

1. Rotate the mode dial to **ART**.

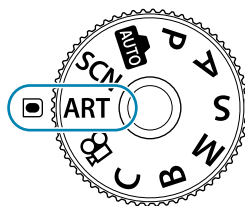

2. Use $\triangleleft \triangleright$ to highlight a filter.

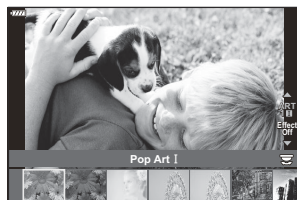

3. Press ∇ , highlight an effect using $\triangleleft \triangleright$, and press the **OK** button.

4. Take pictures.

- Press the **OK** button to choose a different art filter. If effects are displayed, press \triangle .
- The effects available vary with the selected filter (Soft Focus Effect, Pin Hole Effect, Frame Effect, White Edge Effect, Star Light Effect, Color Filter, Monochrome Color, Blur Effect, or Shade Effect).

Types of art filters

Pop Art I/II	Creates an image that emphasizes the beauty of color.
Soft Focus	Creates an image that expresses a soft tone atmosphere.
Pale&Light Color I/II	Creates an image that expresses warm light by scattering overall light and slightly overexposing the image.
Light Tone	Creates a high-quality image by softening both shadows and highlights.
Grainy Film I/II	Creates an image that expresses the roughness of black and white images.
Pin Hole I/II/III	Creates an image that looks as if it was taken using an old or toy camera by dimming the image perimeter.
Diorama I/II	Creates a miniature-like image by emphasizing saturation and contrast, and blurring unfocused areas.
Cross Process I/II	Creates an image that expresses a surreal atmosphere. Cross Process II creates an image that emphasizes magenta.
Gentle Sepia	Creates a high-quality image by drawing out shadows and softening the overall image.
Dramatic Tone I/II	Creates an image that emphasizes the difference between brightness and darkness by partially increasing contrast.
Key Line I/II	Creates an image that emphasizes edges and adds an illustrative style.
Watercolor I/II	Creates a soft, bright image by removing dark areas, blending pale colors on a white canvas, and further softening contours.
Vintage I/II/III	Expresses an everyday shot in a nostalgic, vintage tone using printed film discoloration and fading.
Partial Color I/II/III	Impressively expresses a subject by extracting colors you want to emphasize and keeping everything else monotone.

Bleach Bypass I/II	The “bleach bypass” effect, which you may recognize from motion pictures and the like, can be used to great effect in shots of streetscapes or metal objects.
Instant Film	A contemporary take on the shadow and skin tones typical of film.
ART BKT (ART bracketing)	Records images using all art filter options with a single shot. Press the INFO button on the selection screen to select a filter to record with.

II and III are altered versions of the original (I).

- ① To maximize the benefits of the art filters, some of the shooting function settings are disabled.
- ① If **[RAW]** is currently selected for image quality (P. 139), image quality will automatically be set to RAW+JPEG. Art filters apply only to the JPEG copy.
- ① Depending on the scene, the effects of some settings may not be visible, while in other cases tone transitions may be ragged or the image rendered more “grainy”.
- ① Some effects may not be visible during movie recording.
- ① Playback may differ according to the filters, effects, or movie quality settings applied.

Using [Partial Color]

Record only selected hues in color.

1. Rotate the mode dial to **ART**.
2. Select **[Partial Color I/II/III]** in the art filter menu.
3. Highlight an effect and press the **OK** button.
 - A color ring appears in the display.



4. Rotate the front or rear dial to choose a color.
 - The effect is visible in the display.
5. Take pictures.
 - To choose a different color after shooting, rotate the front or rear dial to display the color ring.

Saving Custom Settings to the Mode Dial (C Custom mode)

Frequently-used settings and shooting modes can be saved as custom modes and recalled as needed simply by rotating the mode dial. Saved settings can also be recalled directly from the menus.

- Save settings to positions **C** through **C4**.
- At default settings, custom modes are equivalent to mode **P**.

Saving Settings (Assign to Custom Mode)

1. Adjust camera settings as desired.
 - Rotate the mode dial to a setting other than **AUTO**, **SCN**, or **ART**, or movie.
 - For information on the settings that can be saved, see "Default Settings" (P. 390).
2. Press the **MENU** button to view the menus.
3. Highlight **[Reset / Custom Modes]** in  Shooting Menu 1 and press the **▷** button.

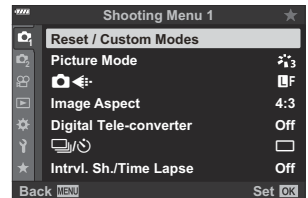

- **[Reset / Custom Modes]** options will be displayed.

4. Highlight **[Assign to Custom Mode]** using the **△** **▽** buttons and press the **▷** button.

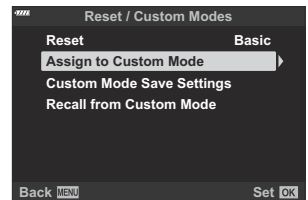

- **[Assign to Custom Mode]** options will be displayed.

5. Highlight the desired custom mode ([**Custom Mode C**]– [**Custom Mode C4**]) using Δ ∇ buttons and press the \triangleright button.
- The menu for the selected custom mode will be displayed.

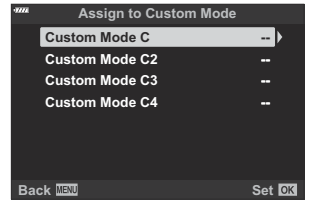

6. Highlight [**Set**] using the Δ ∇ buttons and press the **OK** button.

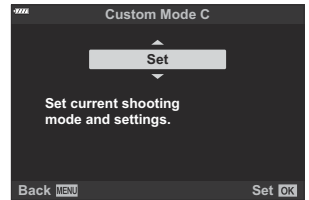

- The [**Assign to Custom Mode**] menu will be displayed again.
 - Any existing settings will be overwritten.
 - To restore default settings for the selected custom mode, highlight [**Reset**] and press the **OK** button.
7. Press the **MENU** button repeatedly to exit the menu.

Using Custom Modes (C)

To recall all saved settings, including the shooting mode:

Recalling Settings with the Mode Dial

1. Rotate the mode dial to **C**.

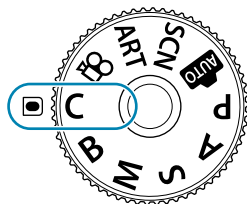

- The camera will recall the settings for **[Custom Mode C]** previously saved using **[Reset / Custom Modes]** > **[Assign to Custom Mode]** in Shooting Menu 1 (P. 77).

2. Take pictures.



- By default, changes made after recall will not be applied to the stored settings. The saved settings will be restored when next you select the custom mode with the mode dial.
- If **[Hold]** is selected for **[Custom Mode Save Settings]**, custom modes will be updated automatically to reflect any changes made to settings while the mode is selected during shooting. The changes will remain stored in the custom mode even after the mode dial is rotated to another setting. Custom modes can be used in much the same way as modes **P**, **A**, **S**, **M**, and **B**.

Recalling Saved Settings

In modes other than **AUTO**, **SCN**, **ART**, and , you can recall the settings stored in custom modes **[Custom Mode C]** through **[Custom Mode C4]** but not the shooting mode. The shooting mode remains that currently selected with the mode dial.



- Recalling settings with the mode dial rotated to **C** restores all saved settings, including the shooting mode.

1. Press the **MENU** button to view the menus.

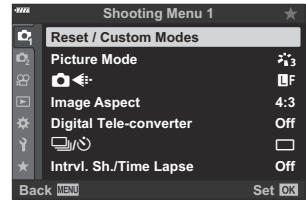
2. Highlight **[Reset / Custom Modes]** in  Shooting Menu 1 and press the  button.



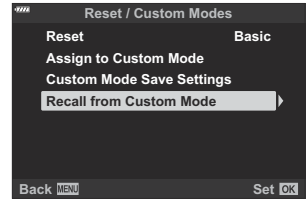

- **[Reset / Custom Modes]** options will be displayed.

3. Highlight **[Recall from Custom Mode]** using the   buttons and press the  button.



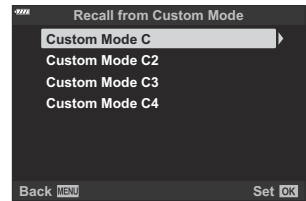

- The **[Recall from Custom Mode]** menu will be displayed.

4. Highlight the desired custom mode using the   buttons and press the  button.

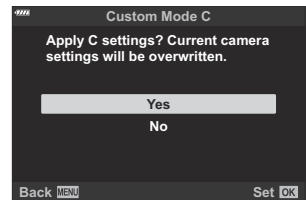

5. Highlight **[Yes]** using the   buttons and press the **OK** button.



-  Shooting Menu 1 will be displayed.

 Current settings will be saved to the selected mode, overwriting previously-saved settings.

6. Press the **MENU** button to exit the menus.

⚙️ Settings recalled by pressing a button will cease to apply if you:

- turn the camera off,
- rotate the mode dial to another setting,
- press the **MENU** button during shooting
- perform a reset, or
- save or recall custom settings.

Updating Custom Modes Automatically

Custom modes can be updated automatically to reflect any changes made to settings while the mode is selected during shooting.

1. Highlight **[Reset / Custom Modes]** in  Shooting Menu 1 and press the **OK** button.
2. Highlight **[Custom Mode Save Settings]** and press the **▷** button.
3. Highlight a custom mode (**[Custom Mode C1]**–**[Custom Mode C4]**) and press the **OK** button.
4. Highlight **[Hold]** and press the **OK** button.

Recording Movies

- ① When recording movies, use an SD card that supports an SD speed class of 10 or higher.
- ① A UHS-II or UHS-I card with a UHS speed class of 3 or better is required when:
 - a movie resolution of **[4K]** or **[C4K]** is selected in the [] menu or a bit rate of **[A-I]** (All-Intra) is selected in the [] menu
- ① If the camera is used for extended periods, the temperature of the image sensor will rise and noise and colored fog may appear in images. Turn off the camera for a short time should this occur. Noise and colored fog may also appear in images recorded at high ISO sensitivity settings. If the temperature rises further, the camera will turn off automatically.
- ① AF is not available during movie recording with Four Thirds system lenses.
- ① When (high-speed movie recording) is selected for [], movies shot with **[i-Enhance]**, **[e-Portrait]**, or an art filter selected for picture mode will be recorded in **[Natural]** mode.
- ① CMOS image sensors of the type used in the camera generate a so-called “rolling shutter” effect that can cause distortion in pictures of moving objects. This distortion is a phenomenon that occurs in pictures of fast-moving subjects or if the camera is moved during shooting. It is particularly noticeable in pictures taken at long focal lengths.
- ① When an SDXC card is used, movies over 2 hours are recorded over multiple files (depending on shooting conditions, the camera may start recording to a new file before the 2-hour limit is reached).
- ① When an SD/SDHC card is used, movies over 4 GB in size are recorded over multiple files (depending on shooting conditions, the camera may start recording to a new file before the 4 GB limit is reached).
- 📷 Camera orientation is recorded when movies are filmed in portrait (“tall”) orientation. Movies viewed on a computer or smartphone will be displayed in the orientation in which they were recorded.

Recording movies in photo shooting modes

The button can be used for movie recording even when the mode dial is not in the position.

- ① The AF frame will switch to the style selected for movie mode. Before recording, rotate the mode dial to (movie mode) and choose the desired AF frame in the AF-target selection display (P. 91).

1. Press the button to begin recording.

- A “REC” indicator, the recording time, and a red frame are displayed during movie recording.
- If you put your eye to the viewfinder, the movie you are recording will be displayed in the viewfinder.
- You can change the focus location by tapping the monitor while recording.

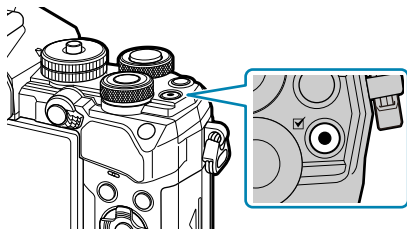





2. Press the button again to end recording.

- The “REC” indicator, recording time, and frame will clear from the display when recording ends.
- The sound of touch operations and button operations may be recorded.

 The  button cannot be used to record movies in the following instances:

- during multiple exposure (still photography also ends.), while shutter button is pressed halfway, in mode **B** (bulb), during sequential shooting, during time lapse shooting, during keystone compensation, during fisheye correction, during LV ND shooting

 Some settings, such as AF mode, can be set separately for movies and photographs.  “The Video Menu” (P. 233)

 To choose whether the display is bordered in red while recording is in progress, use  **Display Settings**] > **[Red Frame during REC]** in the  Video Menu (P. 233).



Recording movies in movie mode ()



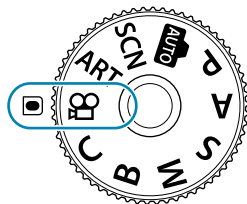

Rotate the mode dial to  (movie mode) to record movies using the effects available in **P**, **A**, **S**, and **M** modes (P. 238).

1. Rotate the mode dial to .



2. Press the  button to begin recording.

- Configuring the shutter button so that it can be used to record movies requires changes to **[ Shutter Function]**.  **Video Menu > [ Shutter Function]** (P. 233)
- A beep does not sound when the camera focuses in movie mode.
- The movie you are recording will be displayed on the monitor.
- A red frame is displayed during movie recording.
- If you put your eye to the viewfinder, the movie you are recording will be displayed in the viewfinder.
- You can change the focus location by tapping the monitor while recording.
- The camera will start the movie recording count and display the elapsed recording time.



 To choose whether the display is bordered in red while recording is in progress, use **[ Display Settings]** > **[Red Frame during  REC]** in the  Video Menu (P. 233).

Touch Controls (Silent Controls)

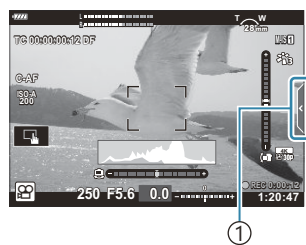
You can prevent the camera from recording operating sounds that occur due to camera operations while shooting. Tapping the silent shooting tab displays the following items. After tapping an item, tap the displayed arrows to select the settings.



① Silent shooting tab

	(power zoom)	Zoom power zoom lenses in or out.
	(recording level)	Choose the recording level.



SS	(shutter speed)	Adjust shutter speed when [S] (shutter-priority AE) or [M] (manual) is selected for [Movie Mode] (movie exposure mode; P. 238).
FNo	(aperture)	Adjust aperture when [A] (aperture-priority AE) or [M] (manual) is selected for [Movie Mode] (movie exposure mode; P. 238).
	(exposure compensation)	Adjust exposure compensation. Available when [AUTO] is selected for [ISO] (P. 98) with [M] selected for [Movie Mode] (movie exposure mode; P. 238).
ISO	(ISO sensitivity)	Adjust [ISO] (P. 98). Displayed when [M] is selected for [Movie Mode] (movie (exposure) mode; P. 238).

 Silent controls are not available during high-speed movie recording ([P. 144](#)).

Shooting Settings

Shooting Settings

The camera offers many photography-related functions. Depending on how often you use them, you can access settings via buttons, icons in the display, or menus that can be used for detailed adjustments.

Method	Description
Direct buttons	Adjust settings directly using buttons, including those listed below. Commonly-used functions are assigned to buttons for quick access during viewfinder photography (P. 87). <ul style="list-style-type: none">• The controls that can be so used include the , , , and ISO buttons.
LV super control panel/ super control panel	Choose from a list of settings showing current camera status. You can also view current camera settings (P. 111).
Live controls	Adjust settings while viewing your subject in the display (P. 331).
Menus	Adjust settings from menus displayed in the monitor (P. 200).

Direct Buttons



Direct Buttons

Frequently-used photographic functions are assigned to buttons. These are referred to as “direct buttons”.

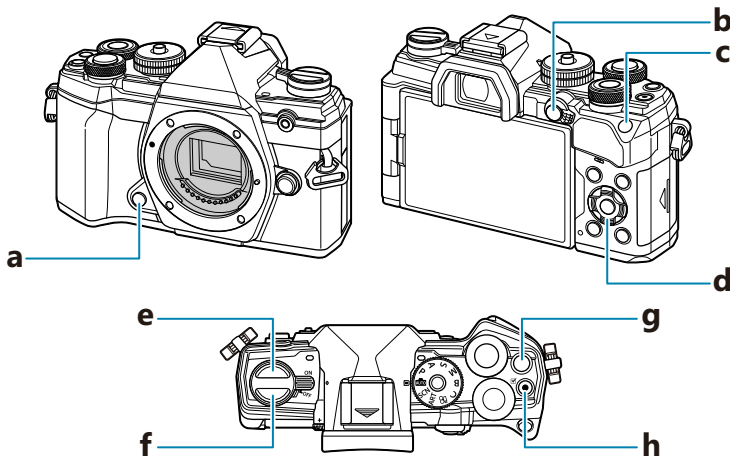
The buttons to which functions can be assigned are listed below.





Direct button		Assigned function
a	Preview button	Preview (P. 167)
b	AEL/AFL button	AEL/AFL (P. 100)
c	ISO button	ISO sensitivity (P. 98)
d	Arrow pad	[] (AF-target position; P. 91)
e	button	Sequential/self-timer shooting (P. 101)
f	(LV) button	Display (monitor/viewfinder) selection (P. 40)

Direct button		Assigned function
g	 button	Exposure compensation (P. 89)
h	 button	Movie recording (P. 82)

 Buttons can be assigned different roles.  [\[📷 Button Function\] \(P. 167\)](#)

Controlling exposure (Exposure Compensation)

The exposure selected automatically by the camera can be altered to suit your artistic intent. Choose positive values to make pictures brighter, negative values to make them darker. Exposure compensation is available in modes **P**, **A**, **S**, **ART**, and .

 To enable exposure compensation in mode **M**, select **[AUTO]** for **[ISO]** (P. 98).



- ① Negative (-)
- ② No compensation (0)
- ③ Positive (+)

- During photo shooting, exposure compensation can be adjusted by up to ± 5.0 EV. The viewfinder and live view show the effects of values not exceeding ± 3.0 EV. The exposure bar flashes when the value exceeds ± 3.0 EV.
- During movie recording, exposure compensation can be adjusted by ± 3.0 EV.







- ① Exposure compensation
- ② Exposure bar

- To preview the effects of exposure compensation in live view, select **[Off]** for **[Live View Boost]** in  **Custom Menu D2** (P. 280).
- The front and rear dials or touch controls can be used to adjust exposure during movie recording.





Adjusting Exposure Compensation

Modes P, A, and S

In movie mode, exposure compensation can be adjusted when **[P]**, **[A]**, or **[S]** is selected for **[Mode]** (movie exposure mode).  “Choosing an Exposure Mode (Mode (Movie Exposure Mode))” (P. 238)

1. Rotate the front dial to adjust exposure compensation.
 - You can also choose a value by pressing the  button and then using the   buttons.
2. Take pictures.

Mode M

In movie mode, exposure compensation can be adjusted when **[M]** is selected for **[Mode]** (movie exposure mode). You must first however select **[On]** for  Video Menu >  Specification Settings >  ISO-Auto Set >  ISO-Auto (P. 233) and **[AUTO]** for  ISO (P. 98).

1. Press the  button and then rotate the front dial or rear dial to adjust exposure compensation.
2. Take pictures.

Resetting Exposure Compensation

To reset exposure compensation, press and hold the **OK** button.

Choosing an AF Target Mode (AF Target Mode)

1. Use the Δ ∇ \triangleleft \triangleright buttons to position the AF target.
2. Use the front dial during AF target selection to choose the target's size and shape.

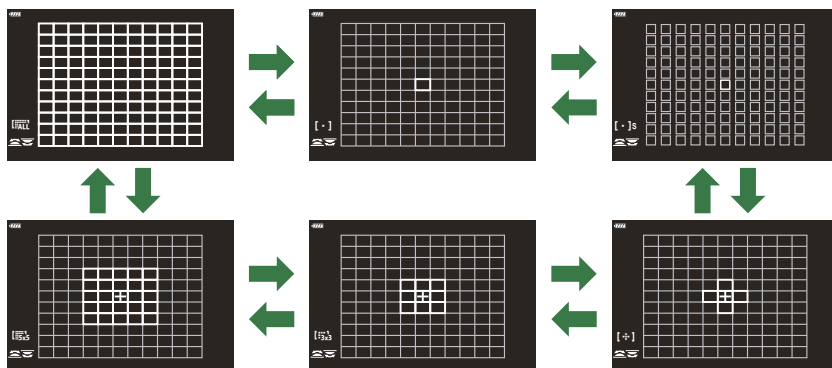

AF Target Modes

- The only modes available when \square AF is selected are single target, 9-target group (3 × 3), and 25-group (5 × 5) modes.
- The only options available during movie recording are single target, 9-target group (3 × 3), 25-target group (5 × 5), and all target (11 × 9) modes.
- Use $\left[\begin{smallmatrix} \square \\ \cdot \\ \cdot \\ \cdot \end{smallmatrix} \right]$ Mode Settings in $\left[\begin{smallmatrix} \star \\ \cdot \\ \cdot \\ \cdot \end{smallmatrix} \right]$ Custom Menu $\left[\begin{smallmatrix} \square \\ \cdot \\ \cdot \\ \cdot \end{smallmatrix} \right]$ (P. 271) to choose the AF target modes displayed.

[·] Single Target

Select a single focus target.

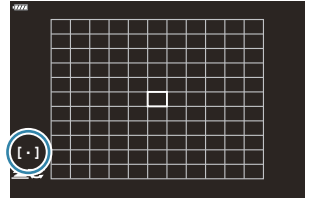

[·]s Small Target

Further reduce the target size for single-target AF-target selection. Use for pinpoint focus on small subjects.

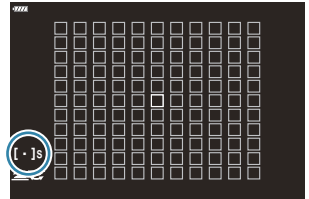

[·] 5-Target Group

Select a group of 5 targets, arranged in a cross. The camera chooses the target used for focus from within the selected group.

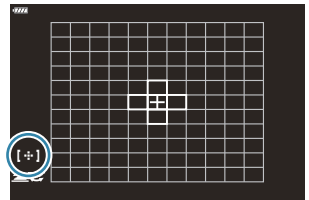

[·] 9-Target Group (3 × 3)

Select a group of 9 targets, arranged in a square. The camera chooses the target used for focus from within the selected group.

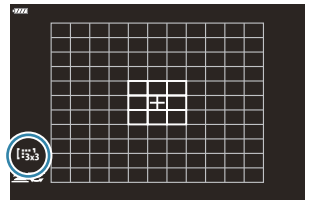

25-Target Group (5 × 5)

Select a group of 25 targets, arranged in a square. The camera chooses the target used for focus from within the selected group.

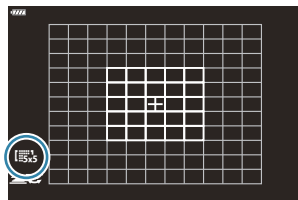



All Targets

The camera chooses the target used for focus from all available targets.

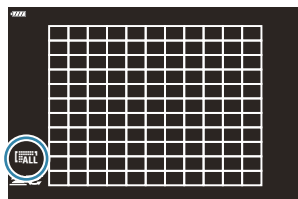



- The camera chooses from 121 (11 × 11) targets during still photography and from 99 (11 × 9) targets in movie mode.



Custom Target

Custom target modes can be displayed by going to   **Mode Settings** in  **Custom Menu A2** (P. 271) and placing checks (✓) next to the desired options.

The camera uses the AF target mode selected for  **Target Mode Settings** in  **Custom Menu A2** (P. 271). The default setting is single target.

 Separate AF target modes can be selected according to camera orientation.   **Custom Menu A2** >  **Orientation Linked [:::]** (P. 310)

 The following focus settings can be recalled simultaneously using the **Fn** lever. Separate settings can be assigned to Positions 1 and 2. Use this option to quickly adjust settings according to shooting conditions.

- **[AF Mode]** (P. 118), **[AF Target Mode]** (P. 91), and **[AF Target Point]** (P. 95)

The **Fn** lever can be configured using the  **Fn Lever Function** item in  **Custom Menu B** (P. 321) or the  **Button/Dial/Lever** >  **Fn Lever Function** item in the  **Video Menu** (P. 233).

 You can adjust AF target settings for **[C-AF]**.   **Custom Menu A1** >  **C-AF Center Start** (P. 303) and  **C-AF Center Priority** (P. 304)

 Separate options can be selected for still photography and movie mode.

 The number of AF targets available may be reduced depending on shooting settings.

To enable cluster AF targeting when **ALL** (all targets) is selected and either **[C-AF]** is chosen for **[AF Mode]** or **[S-AF]**, **[S-AF MF]**, **[C-AF]**, or **[C-AF MF]** is chosen for **[AF Mode]** (P. 118), select **[On2]** for **Custom Menu A2 > [AF Area Pointer]** (P. 271). The camera will display AF targets for all areas that are in focus.



Choosing a Focus Target (AF Target Point)

The frame showing the location of the focus point is referred to as the “AF target”. You can position the target over your subject.

1. At default settings, you can position the target using the Δ ∇ \triangleleft \triangleright buttons.
2. Position the selected target using the Δ ∇ \triangleleft \triangleright buttons.



- To select the center AF target, press and hold the **OK** button.
- You can choose whether AF-target selection “wraps around” the edges of the display (P. 308).

🔗 You can reposition the AF target during focusing when **[C-AF]** or **[C-AF MF]** is selected in still photography mode.

🔗 You can also reposition the AF target during movie recording.

🔗 When **[On]** is selected for **[AF Targeting Pad]** (P. 273), you can reposition the AF target using monitor touch controls while framing your subject in the viewfinder.

🔗 The size and number of available AF targets vary with group target settings (P. 91) and the options chosen for **[Digital Tele-converter]** (P. 208) and **[Aspect]** (P. 138).

🔗 The roles played by the dials and arrow pad during AF-target selection can be chosen using **[[:]] Select Screen Settings** in **⚙ Custom Setting Menu A2** (P. 307).

Zoom frame AF/Zoom AF (Super Spot AF)

You can zoom in on the display during shooting. For greater precision during focusing, zoom in on the focus area. At higher zoom ratios, you can focus on areas smaller than the standard focus target. You can reposition the focus area as desired during zoom.

⚠ This function is only available when [Q] is assigned to a camera control. 🖱️ ["Assigning functions to buttons \(Button Function\)" \(P. 167\)](#), ["Available Roles" \(P. 169\)](#)

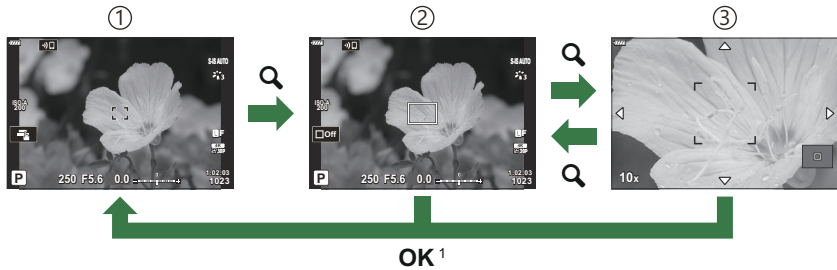

1 To return to the shooting display, you have the option of pressing and holding the control to which [Q] (magnify) is assigned instead of pressing the **OK** button.

① Shooting display

③ Zoom AF display

② Zoom frame AF display

1. Press the button to which [Q] (magnify) is assigned.

- The zoom frame will be displayed.

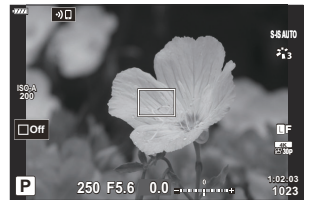

2. Position the frame using the Δ ∇ \triangleleft \triangleright buttons.

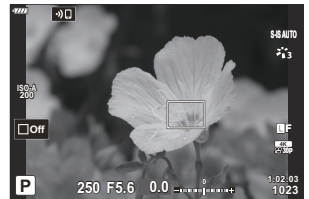

- To re-center the frame, press and hold the **OK** button.

3. Adjust the size of the zoom frame to choose the zoom ratio.

- Press the **INFO** button and then use the Δ ∇ buttons or the front or rear dial to adjust the size of the zoom frame.



- Press the **OK** button to accept and exit.

4. Press the button to which [**Q**] is assigned once more.

- The camera will zoom the selected area in to fill the display.
- Use the front or rear dial to zoom in or out.
- Use the Δ ∇ \triangleleft \triangleright buttons to scroll the display.



- In shooting mode **M** (manual) or **B** (bulb), you can press the **INFO** button during zoom to choose aperture or shutter speed.

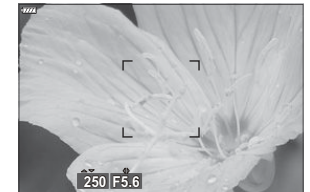

Exposure adjustment display
for modes **M** and **B**

- Press the **Q** button to return to the zoom frame.
- Press the **OK** button to end focus zoom.
- You can also end focus zoom by pressing and holding the **Q** button.

5. Press the shutter button halfway to focus using autofocus.

Focus zoom applies to the display only. Pictures taken with the camera are not affected.

Touch controls can be used for focus zoom. ["Shooting with touch screen operations" \(P. 46\)](#)

You can make the area in the zoom frame brighter for easier focus or configure the camera to exit focus zoom when the shutter button is pressed halfway to focus. [Custom Menu D2 > \[LV Close Up Settings\] \(P. 280\)](#)

Changing ISO sensitivity (ISO)

Select a value according to subject brightness. Higher values let you photograph darker scenes but also increase image “noise” (mottling). Select **[AUTO]** to let the camera adjust sensitivity according to lighting conditions.

- ISO sensitivity is fixed at **[AUTO]** during movie recording when **[P]**, **[A]**, or **[S]** is selected for **[Mode]** (movie exposure mode). Setting **[Mode]** to **[M]** allows other options to be selected.

1. Press the **ISO** button, and rotate the front or rear dial to select a value.







AUTO	<p>Sensitivity is adjusted automatically according to shooting conditions.</p> <p>Use [ISO-Auto Set] in Custom Menu (P. 284) to choose the maximum sensitivity selected by the camera and the shutter speed at which auto sensitivity control takes effect during still photography.</p> <p>During movie recording, ISO sensitivity will be set to values of from ISO 200 to 6400. You can also choose maximum and standard values for ISO sensitivity.</p>
L64, L100, 200–25600 (still photography)	<p>Choose a value for ISO sensitivity. ISO 200 offers a good balance between noise and dynamic range. Choose [L100] or [L64] for larger apertures (lower f-numbers) or slower shutter speeds. [L64] is equivalent to ISO 64, [L100] to ISO 100.</p> <ul style="list-style-type: none">• [L64] and [L100] are available at all exposure step values.• [L64] and [L100] reduce dynamic range.
200–6400 (movie recording)	<p>Choose a value for [ISO]. ISO 200 offers a good balance between noise and dynamic range. This option is available when [M] is selected for [Mode] (movie exposure mode).</p>

- ① Combining **[ISO]** values over ISO 8000 with settings that use an electronic shutter (for example, silent mode or focus bracketing) sets the flash sync speed to 1/20 s.
- ① Regardless of the value selected for ISO sensitivity, the flash sync speed for photos taken using ISO bracketing in silent mode is 1/20 s.
- ① When **[M]** is selected for **[Mode]** (movie exposure mode), ISO sensitivity can be adjusted during recording using touch controls (P. 84) or by rotating the front or rear dial.

- ⓘ If **[Dramatic Tone]** or **[Watercolor]** is chosen for picture mode during still photography, sensitivity will not exceed ISO 1600 when **[AUTO]** is selected.
- ⓘ The following restrictions apply when **[M]** is selected for **[Movie Mode]** (movie exposure mode):
 - **[OM-Log400]** selected for picture mode:
 - If the frame rate selected for **[Frame Rate]** is 24p, 25p, or 30p, **[AUTO]** is restricted to sensitivities of ISO 400–3200.
 - If the frame rate selected for **[Frame Rate]** is 50p or 60p, **[AUTO]** is restricted to sensitivities of ISO 400–6400.
 - The lowest value that can be selected manually is ISO 400.
 - **Other picture modes:**
 - If the frame rate selected for **[Frame Rate]** is 24p, 25p, or 30p, **[AUTO]** is restricted to sensitivities of ISO 200–3200.

Locking Exposure (AE Lock)

You can lock the exposure by pressing the **AEL/AFL** button. Use this when you want to adjust the focus and exposure separately or when you want to shoot several images at the same exposure.

- ⓘ AE lock is available only when **[mode1]** or **[mode2]** is selected for  **AEL/AFL** (P. 299) during still photography (note, however, that when  **AF** or  **AF ME** is selected for AF mode, AE lock is available only in **[mode1]**).
- If the **AEL/AFL** button has been assigned a different role, you will need to assign **[AEL/AFL]** to another control.  “Assigning functions to buttons (Button Function)” (P. 167), “Available Roles” (P. 169)
 - If you press the AEL/AFL button once, the exposure is locked and  is displayed.  “Setting Focus and Exposure with the **AEL/AFL** Button ( AEL/AFL)” (P. 299)
 - Press the AEL/AFL button once again to release the AE Lock.
 - The lock will be released if you operate the mode dial, **MENU** button, or **OK** button.

Performing the sequential/self-timer shooting







Adjust settings for burst or self-timer photography. Choose an option according to your subject.







🔧 Fix the camera securely on a tripod for self-timer shooting.

1. Press the  button.

2. Rotate the front or rear dial to select a value.

- Custom self-timer options can be viewed by pressing the **INFO** button.

	Single	Single-frame advance. The camera takes one photo each time the shutter button is pressed all the way down.
	Sequential High	The camera takes photos at up to about 10 fps while the shutter button is held all the way down. Focus, exposure, and white balance are locked at the values for the first shot in each series.
	Sequential Low	The camera takes photos at up to about 6 fps while the shutter button is held all the way down. You can choose the frame advance rate and the maximum number of shots in each series (P. 322). Focus and exposure conform to the options selected for [AF Mode] (P. 118) and [AEL/AFL] (P. 299). If [C-AF] or [C-AF+TR] is selected for [AF Mode] , the camera will focus before each shot.
	 12sec	The shutter is released 12 s after the shutter button is pressed all the way down. The self-timer lamp will light for about 10 s and then start to flash about 2 s before the shutter is released. The camera focuses when the shutter button is pressed halfway.
	 2sec	When the shutter button is pressed all the way down, the self-timer lamp will start to flash and a photo will be taken after about 2 seconds. The camera focuses when the shutter button is pressed halfway.



	Custom Self-Timer	Adjust self-timer settings, including the self-timer delay and the number of shots taken when the timer expires (P. 104).
 (sample icon)	Anti-Shock [◆]	Reduce the slight blur caused by shutter motion. Available in single-frame, sequential low, and self-timer modes (P. 105).
 (sample icon)	Silent [♥]	Take pictures with the electronic shutter. Use for shutter speeds faster than 1/8000 s or in settings where the sound of the shutter would be unwelcome. Available in single-frame, sequential low, sequential high, and self-timer modes. In  mode, focus, exposure, and white balance are locked at the values for the first shot in each series.
Pro CapH	Pro Capture High¹	Capture starts when the shutter button is pressed halfway. The camera starts recording pictures, including those captured while the button was pressed halfway, when the button is pressed all the way down (P. 107). In Pro CapH mode, focus, exposure, and white balance are locked at the values metered when the shutter button is pressed halfway.
Pro CapL	Pro Capture Low¹	
	High Res Shot¹	Take high-resolution photos (P. 109). Use [High Res Shot] > [Shooting Method] in  Shooting Menu 2 (P. 212) to choose a shooting method.

¹ Art filter picture modes cannot be used.







 To cancel the activated self-timer, press .

 If you stand in front of the camera to press the shutter button when using the self-timer, the picture may be out of focus.

 You can choose the frame advance rate and the maximum number of shots in each series (P. 322).



 In  and **Pro CapL** modes, the camera displays the view through the lens during shooting. In  and **Pro CapH** modes, it displays the shot immediately preceding the current frame.

 The speed of sequential shooting varies depending on the lens you are using and the zoom position.





- ⚠ During sequential shooting, if the battery level icon blinks due to low battery, the camera stops shooting and starts saving the pictures you have taken on the card. The camera may not save all of the pictures depending on how much battery power remains.
- ⚠ Use [ **Settings**] in  **Custom Menu 01** (P. 279) to choose the modes displayed.
- ⚠ In  and  modes, the frame advance rate will drop at **[ISO]** settings over ISO 8000.
- ⚠ The flash sync speed when **[Silent [♥]]** is selected is 1/50 s. It drops to 1/20 s at **[ISO]** settings over ISO 8000.
- ⚠ Photographs taken in silent and pro-capture modes may be distorted if the subject or camera moves quickly during shooting.
- ⚠ To use the flash in **[Silent [♥]]** mode, select **[Allow]** for **[Anti-Shock [♦]/Silent [♥]]** > **[Silent [♥] Mode Settings]** > **[Flash Mode]** in  Shooting Menu 2.
- ⚠ The frame advance rate may slow when **[On1]** or **[On2]** is selected for live view boost. Select **[Off]** to maintain a consistent frame rate.   **Custom Menu 02** > **[Live View Boost]** (P. 280)

Self-Timer Options (🕒 Custom Self-timer)

Adjust self-timer settings, including the shutter release delay and the number of shots taken when the timer expires.

1. Press the  button.
2. Highlight  (custom self-timer) by rotating the front or rear dial and press the **INFO** button.





3. Highlight items using   and use   to choose an option.

 Timer	Choose how long the camera waits to begin shooting after the shutter button is pressed all the way down.
Number of Frames	Choose the number of shots taken when the timer expires.
Interval Length	If the number of shots is 2 or more, choose the interval between the shots taken when the timer expires.
Every Frame AF	[Off]: If the number of shots is 2 or more, the camera will focus only before the first shot. [On]: The camera focuses before each shot.

Shooting without the vibration caused by shutter button operations (Anti-Shock [◆])

Reduce the slight blur caused by shutter motion.

Use this option when even slight camera motion can cause blur, for example during macro or telephoto photography.

ⓘ You must first enable display of this option by selecting [/🔄 **Settings**] in  **Custom Menu**  (P. 279) and placing a check (✓) next to the appropriate item.



1. Press the  button.
2. Select one of the items marked ◆ using the front or rear dial and press the **OK** button.
3. Take pictures.
 - When the set time has elapsed, the shutter is released and the picture is taken.

🔍 The delay between the shutter button being pressed all the way down and the start of shooting can be selected using [**Anti-Shock [◆]/Silent [♥]**] > [**Anti-Shock [◆]**] in  Shooting Menu 2 (P. 232).

Shooting without shutter sound (Silent [♥])

In situations where the shutter sound is a problem, you can shoot without making a sound. An electronic shutter is used to reduce the minuscule camera shake caused by the motion of the mechanical shutter, much as is the case for anti-shock photography.

1. Press the  button.
2. Select one of the items marked ♥ using the front or rear dial and press the **OK** button.
3. Take pictures.
 - When the shutter is released, the monitor screen will go dark for a moment. No shutter sound will be emitted.
 - The fastest available shutter speed is 1/32000 s.

-  The desired results may not be achieved under flickering light sources such as fluorescent or LED lamps or if the subject moves abruptly during shooting.
-  The delay between the shutter button being pressed all the way down and the start of shooting can be selected using **[Anti-Shock [♦]/Silent [♥]] > [Silent [♥]]** in  Shooting Menu 2 (P. 232).

Shooting without a release time lag (Pro Capture shooting)

Capture starts when the shutter button is pressed halfway; the moment the button is pressed the rest of the way down, the camera will start saving the last n captured pictures to the memory card, where n is a number selected before shooting begins. If the button is held all the way down, shooting will continue until the selected number of pictures is recorded. Use this option to capture moments you might otherwise miss due to your subject's reactions or shutter lag.

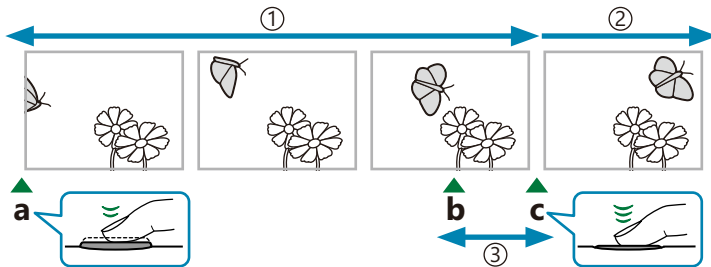

① Up to 14 frames

② Burst shooting continues

③ Shutter lag

a Shutter button pressed halfway

b Moment you want

c Shutter button pressed all the way down

Pro Capture Low (^{Pro}CapL)

Choose this option if you anticipate that the distance to the subject will change during shooting. The camera shoots at up to 10 fps. A maximum of 14 frames can be captured before the shutter button is pressed all the way down. If [C-AF] or [C-AF+TR] is selected for [AF Mode] (P. 118), the camera will focus before each shot.



① Selecting ^{Pro}CapL (Pro Capture Low) restricts aperture to values between maximum aperture and f8.0.

② Four Thirds and third-party Micro Four Thirds lenses cannot be used in ^{Pro}CapL (Pro Capture Low) mode.

Pro Capture High (^{Pro}CapH)



Choose this option if the distance to the subject is unlikely to change very much during shooting. The camera shoots at up to 30 fps. A maximum of 14 frames can be captured before the shutter button is pressed all the way down. The camera will use [S-AF] when [C-AF] or [C-AF+TR] is selected for [AF Mode] (P. 118).

Pro Capture Photography





1. Press the  button.
2. Select **Pro Cap H** (Pro Capture High) or **Pro Cap L** (Pro Capture Low) using the front or rear dial and press the **OK** button.
3. Press the shutter button halfway to start capturing.
 - When the shutter button is pressed halfway, a capture icon () will be displayed. If the button is kept pressed halfway for over a minute, capture will end and the  icon will clear from the display. Press the shutter button halfway again to resume shooting.



4. Press the shutter button all the way down to start saving pictures to the memory card.
 - Shooting will continue while the shutter button is pressed all the way down, up to the number of shots selected for **[Frame Count Limiter]**.



 **[Max fps]** (**Pro Cap H** (Pro Capture High) only), **[Pre-shutter Frames]**, and **[Frame Count Limiter]** can be adjusted using the **[L Settings]** and **[H Settings]** > **[Pro Cap]** options in  Custom Menu .

 ["Burst Shooting Options \(L Settings/H Settings\)"](#) (P. 322)

-  Flickering occurred by fluorescent lights or the large movement of the subject, etc. may cause distortions in images.
-  During capture, the monitor will not go dark and the sound of the shutter will not be heard.
-  The slowest shutter speed is limited.
-  Pro Capture is not available when the camera is connected to a smartphone via Wi-Fi.

Shooting still pictures in a higher resolution (High Res Shot)



Shoot at resolutions higher than that of the image sensor. The camera takes a series of shots while moving the image sensor and combines them to create a single high-resolution photo. Use this option to capture details that normally would not be visible even at high zoom ratios.



1. Press the  button.
2. Highlight  using the front or rear dial.
 - To choose between tripod and hand-held modes, press the **INFO** button and rotate the front or rear dial.
3. Press the **OK** button.

- A  icon will be displayed. The icon will flash if the camera is not steady. The icon stops flashing when the camera is steady and ready to shoot.



- After enabling High Res Shot, check the option selected for image quality. Image quality can be adjusted in the LV super control panel (P. 139).

4. Take pictures.
 - The  will flash to warn that shots may be blurred by camera shake. Keep the camera steady.
 - Shooting is complete when the green  icon clears from the display.
 - The camera will automatically create the composite image when shooting is complete. A message will be displayed during this process.

 Use the **[High Res Shot]** option (P. 212) in  Shooting Menu 2 to choose time between the shutter button being pressed all the way down and the shutter being released, the time allocated for the flash to charge when a flash is used in High Res Shot mode, and the shooting style (tripod-mounted or hand-held).

- ⓘ Choose from JPEG (**60M**F or **25M**F) and RAW+JPEG modes. When image quality is set to RAW+JPEG, the camera saves a single RAW image (extension “.OR1”) before combining it with the high resolution shooting. Pre-combination RAW images can be played back using the latest version of OM Workspace.
- ⓘ **[S-IS Off]** is automatically selected for **[Image Stabilizer]** (P. 134) when **[Tripod]** is chosen for **[Shooting Method]**, **[S-IS AUTO]** when **[Handheld]** is selected.
- ⓘ The maximum wait time for **[Shooting Method]** > **[Handheld]** is 1 second.
- ⓘ During RC flash photography, the maximum flash wait time is 4 seconds and the flash control mode is fixed at MANUAL.
- ⓘ This option is available in **P**, **A**, **S**, and **M** modes.
- ⓘ High Res Shot cannot be used with:
 - interval-timer photography, multiple exposure, keystone compensation, bracketing, fisheye correction, HDR, and LV ND photography.
- ⓘ Pictures taken with **[e-Portrait]** or an art filter selected for picture mode are recorded in **[Natural]** mode.
- ⓘ Image quality may drop under flickering light sources such as fluorescent or LED lamps.
- ⓘ If the camera is unable to record a composite image due to blur or other factors, only the first shot will be recorded. If **[JPEG]** is selected for image quality, the shot will be recorded in JPEG format, while if **[RAW+JPEG]** is selected, the camera will record two copies, one in RAW (.ORF) and the other in JPEG format.

The Super Control/LV Super Control Panel

The Super Control and LV Super Control Panels

The super control/LV super control panel lists shooting settings and their current values. Use the LV super control panel when framing shots in the monitor ("live view"), the super control panel when framing shots in the viewfinder.

- Pressing the **|O| (LV)** button during live view enables viewfinder photography and displays the LV super control panel in the monitor.

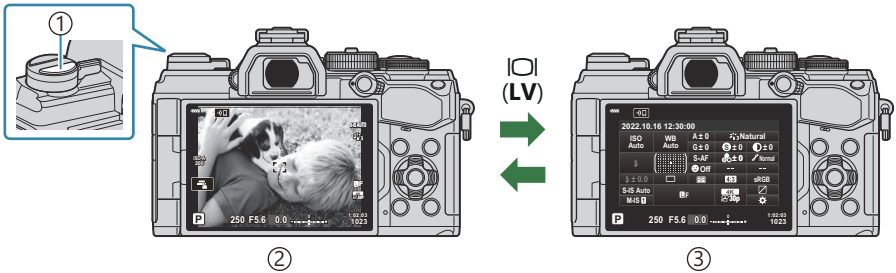

① |O| (LV) button

② Live view photography

③ Viewfinder photography (monitor turns off while viewfinder is on)

LV Super Control Panel (Live View Photography)

To display the LV super control panel in the monitor, press the **OK** button during live view.



Super Control Panel (Viewfinder Photography)

When you frame subjects in the viewfinder, the super LV control panel will be displayed in the monitor at all times. Press the **OK** button to activate the cursor.

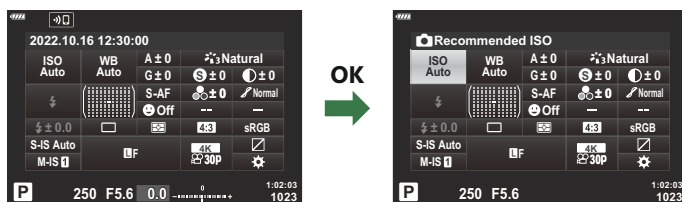

Using the Super Control and LV Super Control panels

1. Press the **OK** button.

- If you press the button during live view, the LV super control panel will be displayed in the monitor.
- The last setting used will be highlighted.

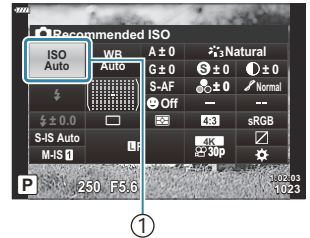

① Cursor

2. Highlight an item using the Δ ∇ \triangleleft \triangleright buttons or by rotating the rear dial.

- The selected setting will be highlighted.
- You can also highlight items by tapping them in the display.

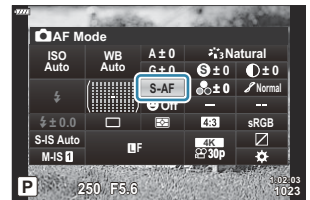
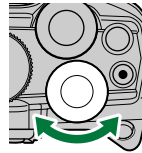

3. Rotate the front dial to change the highlighted setting.

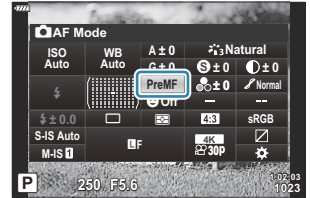
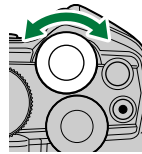

4. Press the shutter button halfway to accept current settings and exit the LV super control panel.

- If you are using the super control panel, the cursor will vanish and setting will end.

Additional Options

Pressing the **OK** button in Step 2 displays options for the highlighted setting.

In some cases, additional options can be configured.

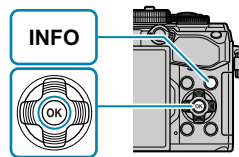

- Touch controls can be used in place of the **OK** button. Lightly tap the desired setting twice to display options.





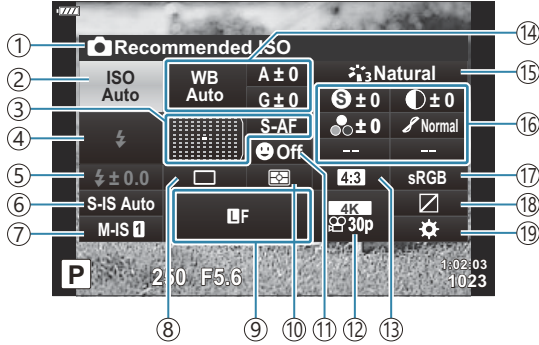



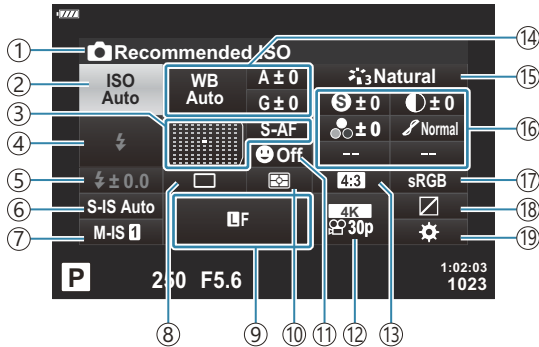





Settings Available in the Super Control/LV Super Control Panel

LV super control panel



Super control panel



- ① Currently selected option
- ② ISO sensitivity (P. 117)
- ③ AF mode (P. 118)
 - AF target (P. 123)
- ④ Flash mode (P. 149)
- ⑤ Flash intensity control (P. 153)
 - Manual flash output (P. 149)
- ⑥  Image stabilizer (P. 134)
- ⑦  Image stabilizer (P. 134)
- ⑧ Sequential shooting/self-timer (P. 137)
- ⑨  Image quality (P. 139)
- ⑩ Metering mode (P. 124)
- ⑪  Face priority (P. 126)
- ⑫  Image quality (P. 141)
- ⑬ Aspect ratio (P. 138)
- ⑭ White balance (P. 129)
 - White balance compensation (P. 133)
 - Color temperature ¹ (P. 129)
- ⑮ Picture mode (P. 154)
- ⑯  Sharpness (P. 158)
 -  Contrast (P. 159)
 -  Saturation (P. 160)
 -  Gradation (P. 161)
 -  Color filter (P. 162)
 -  Monochrome color (P. 163)
 -  Effect (P. 164)
 -  Color ² (P. 74)
 -  Color/vivid ³ (P. 157)
 - Effect ⁴ (P. 73)
- ⑰ Color space (P. 165)
- ⑱ Highlight & shadow control (P. 166)
- ⑲ Button function assignment (P. 167)

1 Displayed when CWB (custom white balance) is selected for white balance.

2 Displayed when Partial Color is set.

3 Displayed when Color Creator is set.

4 Displayed when an art filter is selected.

Changing ISO sensitivity (ISO)

Adjust ISO sensitivity.  “Changing ISO sensitivity (ISO)” (P. 98)

- Separate options can be selected for still photography and movie mode.

1. Press the **OK** button to display the LV super control panel.

2. Highlight **[ISO]** using the Δ ∇ \triangleleft \triangleright buttons.



3. Use the front dial to select an option.

Choosing a focus mode (AF Mode)

You can select a focusing method (focus mode).

- You can choose separate focusing methods for still photography mode and movie mode.

1. Press the **OK** button to display the LV super control panel.



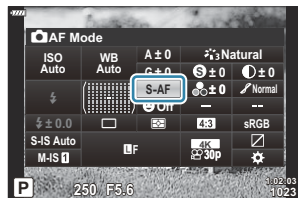



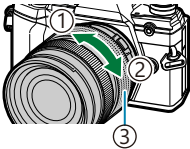

2. Highlight **[AF Mode]** using the Δ ∇ \triangleleft \triangleright buttons.





3. Use the front dial to select an option.





S-AF (Single AF)	The camera focuses once when the shutter button is pressed halfway. During still photography, a beep will sound and the in-focus indicator and AF target will light when the camera focuses. When the camera focuses in movie mode, the in-focus indicator and AF target will light. This mode is suitable for shots featuring stationary or comparatively static subjects.
C-AF (Continuous AF)	During still photography, the camera will adjust focus continuously while the shutter button is pressed halfway. The in-focus indicator is displayed when the subject is in focus. In addition, a beep will sound when the camera focuses for the first time. In movie mode, the camera will adjust focus continuously both before and during filming. Even if the subject moves or you change the composition of the picture, the camera continues trying to focus.
MF (manual focus)	This function allows you to manually focus on any position by operating the focus ring on the lens.  ① Near ② ∞ ③ Focus ring

<p>C-AF+TR (AF Tracking)</p>	<p>Press the shutter button halfway to focus; the camera then tracks and maintains focus on the current subject while the shutter button is held in this position.</p> <p>In movie mode, the camera will continue to track focus on the subject even if you release the shutter button before filming begins. Press the OK button to end focus tracking. The camera will continue to track the subject if recording is started while tracking is in progress.</p> <ul style="list-style-type: none"> • The AF target is displayed in red if the camera can no longer track the subject. Release the shutter button and then frame the subject again and press the shutter button halfway. • Autofocus does not work while the AF target is displayed in red even if the camera is tracking the subject. • Tracking AF cannot be used with: <ul style="list-style-type: none"> - keystone compensation, High Res Shot, focus stacking, focus bracketing, interval-timer photography, HDR, the live ND filter, and fisheye correction.
<p>PreMF (Preset MF)</p>	<p>The camera automatically focuses on the preset focus point when shooting.</p>
<p>☼ AF (Starry Sky AF) (still photography only)</p>	<p>Choose this mode for pictures of stars in the night sky. Press the AEL/AFL button to focus on the stars. 🖱️ “Using Starry Sky AF” (P. 121)</p>

- The camera may be unable to focus if the subject is poorly lit, obscured by mist or smoke, or lacks contrast.
- When using a Four Thirds system lens, AF will not be available during movie recording.
- **[AF Mode]** selection is not available when the lens focus ring is in the MF position and **[Operative]** is selected for **[MF Clutch]** in  **Custom Menu**  (P. 273). 🖱️ [“MF Clutch Lenses” \(P. 429\)](#)
- The **Fn** lever can be used to choose between the **[AF Mode]** settings assigned to **Fn** lever Positions 1 and 2. 🖱️  **Custom Menu**  >  **Fn Lever Function** (P. 275),  **Video Menu** >  **Button/Dial/Lever** >  **Fn Lever Function** (P. 233)

Adjusting Focus Manually During Autofocus

- Before proceeding, select **[On]** for  **AF+MF** in  Custom Menu **A1** (P. 298). **MF** will be displayed next to **[S-AF]**, **[C-AF]**, **[C-AF+TR]**, or  **AF**.

- 1.** Choose a focus mode marked with an **MF** icon (P. 118).
 - For movie recording, select **[S-AF MF]** for  **AF/IS Settings** >  **AF Mode** in the  Video Menu (P. 233).
- 2.** Press the shutter button halfway to focus using autofocus.
 - Press the **AEL/AFL** button to initiate starry sky AF when  **AF MF** is selected.
- 3.** Keeping the shutter button pressed halfway, rotate the focus ring to adjust focus manually.
 - To refocus using autofocus, release the shutter button and press it halfway again.
 - Manual focus adjustment during autofocus is not available in  **AF MF** mode.
 - Manual focus adjustment during autofocus is available via the focus ring on M.ZUIKO PRO (Micro Four Thirds PRO) lenses. For information on other lenses, see our website.
- 4.** Press the shutter button the rest of the way down to take the picture.

Using Starry Sky AF

1. Select **[AF]** for AF mode and press the **OK** button.
2. Press the **AEL/AFL** button to initiate starry sky AF.
 - To interrupt starry sky AF, press the **AEL/AFL** button again.
 - At default settings, starry sky AF does not start when the shutter button is pressed halfway. To configure the camera so that starry sky AF does start when the shutter button is pressed halfway, use **[AEL/AFL]** in **Custom Menu A1** (P. 299).
 - The camera displays **[Starry Sky AF is Running]** during starry sky AF. The in-focus indicator (●) is displayed for about two seconds after the camera focuses; if the camera is unable to focus, the in-focus indicator will instead flash for about two seconds.
3. Press the shutter button all the way down to take the picture.

☞ The **[Starry Sky AF Setting]** item in **Custom Menu A4** (P. 273) offers a choice of **[Accuracy]** and **[Speed]**. Mount the camera on a tripod before taking photographs with **[Accuracy]** selected.

☞ Your choice of AF-target modes (P. 91) is restricted to single target, 9-target group (3 × 3), and 25-target group (5 × 5).

☞ The camera will not be able to focus in bright locations.

☞ Starry sky AF cannot be used with Pro Capture.

☞ **[Orientation Linked [::]]** (P. 310), **[::] Loop Settings** (P. 308), **[AF Limiter]** (P. 312), and the **[AF Illuminator]** item in **Custom Menu A3** (P. 273) are fixed at **[Off]**, the **[Face Priority]** item in **Custom Menu A3** (P. 273) at **[Face Priority Off]**, and the **[AF Scanner]** item in **Custom Menu A1** (P. 270) at **[mode1]**.

☞ The camera automatically focuses at infinity when starry sky AF is selected.

☞ When **[On]** is selected for **[S-AF Release Priority]** in **Custom Menu C1** (P. 277), the shutter can be released even when the subject is not in focus.

☞ Manual focus is selected when a Four Thirds lens is attached.

☞ Starry sky AF is available with OM Digital and OLYMPUS Four Thirds lenses. It cannot, however, be used with lenses with a maximum aperture over f/5.6. For more information, visit our website.

Setting a focus position for PreMF

1. Select **[PreMF]** for AF mode, and press the **INFO** button.

2. Press the shutter button halfway to focus.

- Focus can be adjusted by rotating the focus ring.

3. Press the **OK** button.

- The focus distance for the preset focus point can be set using **[Preset MF distance]** in  **Custom Menu A4** (P. 273).
- The camera also focuses at the preset distance:
 - when turned on and
 - when you exit the menus to the shooting display.

Manual Focus Adjustment

When **[S-AF MF]**, **[C-AF MF]**, **[MF]**, **[C-AF+TR MF]**, **[PreMF]**, or **[* AF MF]** is selected for AF mode, focus can be adjusted manually during exposures or while pictures are being taken in **[Sequential Low]** mode.

- In mode **B** (bulb), manual focus adjustment can be performed according to the option selected for **[Bulb/Time Focusing]** (P. 318).

Positioning and Sizing the AF Target (AF Area)

Adjust AF-target settings.  “Choosing an AF Target Mode (AF Target Mode)” (P. 91), “Choosing a Focus Target (AF Target Point)” (P. 95)

1. Press the **OK** button to display the LV super control panel.
2. Highlight **[AF Area]** using the Δ ∇ \triangleleft \triangleright buttons and press the **OK** button.

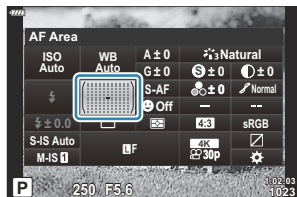

- AF-target selection options will be displayed.
3. Use the front or rear dial to choose an AF-target mode. You can position the target using the Δ ∇ \triangleleft \triangleright buttons.





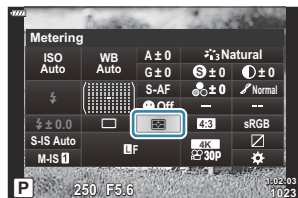

Choosing how the camera measures brightness (Metering)



You can choose how the camera meters subject brightness.

1. Press the **OK** button to display the LV super control panel.
2. Highlight **[Metering]** using the Δ ∇ \triangleleft \triangleright buttons.

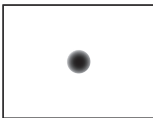

3. Use the front dial to select an option.

	Digital ESP metering	Meters exposure in 324 areas of the frame and optimizes exposure for the current scene or portrait subject (if an option other than [Off] is selected for [☺ Face Priority]). This mode is recommended for general use.	
	Center weighted averaging metering	Provides the average metering between the subject and the background lighting, placing more weight on the subject at the center.	
	Spot metering	Meters a small area (about 2% of the frame) with the camera pointed at the object you wish to meter. Exposure will be adjusted according to the brightness at the metered point.	
	Spot metering (highlight)	Increases spot metering exposure. Ensures bright subjects appear bright.	
	Spot metering (shadow)	Lowers spot metering exposure. Ensures dark subjects appear dark.	

 The spot metering position can be set at the selected AF target.  [Custom Menu](#)  >
[\[!\[\]\(ec842a413a08ae4bb76553a403ab4179_img.jpg\) Spot Metering\]](#) (P. 286)

Face priority AF/Eye priority AF (☺ Face Priority)

The camera automatically detects and focuses on the faces or eyes of portrait subjects.

1. Press the **OK** button to display the LV super control panel.
2. Highlight [**☺ Face Priority**] using the **△ ▽ ◀ ▶** buttons.

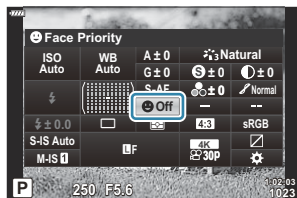

3. Use the front dial to select an option.

	Face Priority On	The camera detects and focuses on faces.
	Face Priority Off	Face priority AF off.
	Face & Eye Priority On	The camera detects faces and focuses on the eye closest to the camera.
	Face & L. Eye Priority On	The camera detects faces and focuses on the left eye.
	Face & R. Eye Priority On	The camera detects faces and focuses on the right eye.

4. Point the camera at your subject.

- Faces detected by the camera are indicated by white frames. The face chosen for focus is indicated by brackets at the corners of the frame. If eye-priority AF is enabled, a white frame will appear over one or the other of the selected subject's eyes.

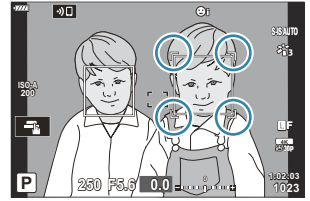

The face chosen for focus is indicated by white double brackets.

- If multiple faces are detected, the face used for focus can be selected via the control to which [☺ **Face Selection**] has been assigned. Pressing this control selects the face nearest the AF target. To choose a different face, hold the control and rotate the front or rear dial. Release the control when the desired subject is selected.  ["Assigning functions to buttons \(Button Function\)"](#) (P. 167)
- The face used for focus can also be selected via touch controls (P. 46).

5. Press the shutter button halfway to focus.

- The area of the subject used for focus is indicated by a green border.
- If the camera detects the subject's eyes, it will focus on an eye.

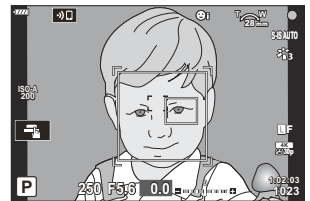



- Face and eye priority are also available in [MF] (P. 118). Faces and eyes detected by the camera are indicated by white frames. Exposure will be set according to the value metered for the center of the face.
- When set to [☒] (P. 124) (Digital ESP metering), metering is performed with priority given to faces.
- If the zoom frame is displayed, the camera will focus on the subject in the zoom frame.





6. Press the shutter button the rest of the way down to shoot.

ⓘ Depending on the subject and the art filter setting, the camera may not be able to correctly detect the face.

🔧 We recommend selecting [**Face Priority Off**] when photographing non-portrait subjects using [**C-AF**] or [**C-AF MF**] in still photography mode.

🔧 Even when faces or eyes are detected, you can opt to focus on a target chosen using AF-target selection rather than on the face or eye selected by the camera.  [Custom Menu A1 >](#) [\[📷 AEL/AFL\] > \[Face Priority AF\]](#) (P. 299)

 **[Face & Eye Priority On]**, **[Face & L. Eye Priority On]**, and **[Face & R. Eye Priority On]** are not available in movie mode.

 Face/eye priority will not be available during  (spot) metering (P. 124) in single-target AF-target mode (P. 91) if  **Spot Metering** is selected in  Custom Menu  (P. 286).

Adjusting color (WB (white balance))

White balance (WB) ensures that white objects in images recorded by the camera appear white.

[AUTO] is suitable in most circumstances, but other values can be selected according to the light source when **[AUTO]** fails to produce the desired results or you wish to introduce a deliberate color cast into your images.

- Separate options can be selected for still photography and movie mode.

1. Press the **OK** button to display the LV super control panel.



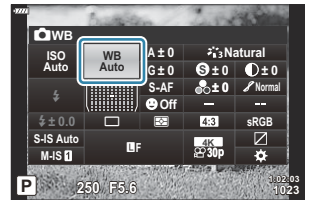







2. Use Δ ∇ \triangleleft \triangleright to select **[WB]**.



3. Use the front dial to select an option.





- One-touch white balance and custom white balance options can be viewed by pressing the **OK** button followed by the **INFO** button.

WB mode		Color temperature	Light conditions
Auto white balance	AUTO	—	<p>Most normal scenes (scenes containing objects that are white or close to white)</p> <ul style="list-style-type: none"> • This mode is recommended in most situations. • You can choose the white balance used under incandescent lighting (P 132).

WB mode		Color temperature	Light conditions
Preset white balance		5300K	Sunlit outdoor scenes, sunsets, fireworks
		7500K	Daylight shots of subjects in the shade
		6000K	Shots taken in daylight under overcast skies
		3000K	Subjects under incandescent lighting
		4000K	Subjects under fluorescent lighting
		—	Underwater photography
		5500K	Light sources with the same color temperature as flash lighting
One-touch white balance	   	Color temperature set by one-touch WB	Situations in which you want to set white balance for a specific subject <ul style="list-style-type: none"> Color temperature is set to a value metered from a white object under the lighting what will be used in the final photograph (P. 131).
Custom white balance	CWB	2000K–14000K	Situations in which you can identify the appropriate color temperature <ul style="list-style-type: none"> Choose a color temperature.

One-touch white balance

Measure white balance by framing a piece of paper or other white object under the lighting that will be used in the final photograph. Use this option to fine-tune white balance when you find it hard to obtain the desired results with white balance compensation or preset white balance options such as ☀ (sunlight) or ☁ (overcast). The camera stores the metered value for quick recall as required.

1. Select [, , , or ] (one-touch white balance 1, 2, 3, or 4).
2. Photograph a piece of colorless (white or gray) paper.
 - Frame the piece of paper so that it fills the display. Ensure that it is free of shadows.
 - In still photography mode, press the **INFO** button and then the shutter button.
 - In movie mode, press the **INFO** button to release the shutter.
 - The one-touch white balance screen appears.
3. Highlight [**Yes**] and press the **OK** button.
 - The new value is saved as a preset white balance option.
 - The new value is stored until one-touch white balance is measured again. Turning the power off does not erase the data.

WB **AUTO** **Keep Warm Color**

Choose how the camera adjusts white balance for pictures taken using auto white balance under incandescent lighting.

1. Highlight **[WB]** and press the **OK** button.
2. After selecting **[AUTO]**, press the **INFO** button.
 - **[WB AUTO Keep Warm Color]** options will be displayed.
3. Highlight an option using the **△ ▽ ◀ ▶** buttons and press the **OK** button.

OFF	The camera suppresses the warm tones produced by incandescent lighting.
ON	The camera preserves the warm tones produced by incandescent lighting.

Making fine adjustments to white balance (WB Compensation)

Fine-tune white balance. Separate values can be selected for each white balance option. Adjust settings as described below.

A	A (amber–blue) axis	Positive values add a red cast, negative values a blue cast.
G	G (green–magenta) axis	Positive values add a green cast, negative values a magenta cast.

1. Press the **OK** button to display the LV super control panel.
2. Highlight **[A±0]** or **[G±0]** using the Δ ∇ \triangleleft \triangleright buttons and choose the desired value using the front dial.



- The effect can be previewed by pressing the **OK** button.

White balance compensation can be applied to all white balance modes simultaneously.

Custom Menu **All** (P. 288), Video Menu > **Specification Settings** > **All** (P. 233)



Changes to white balance can be previewed in live view. During still photography, the effect can be previewed in a photograph. Press the (movie) button in the white balance compensation display to view an image captured at current settings.

Reducing camera shake (Image Stabilizer)

You can reduce the amount of camera shake that can occur when shooting in low light situations or shooting with high magnification.

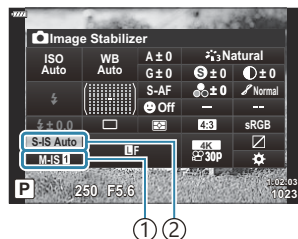
1. Press the **OK** button to display the LV super control panel.
2. Use $\Delta \nabla \triangleleft \triangleright$ to select the image stabilizer.



- ①  Image Stabilizer
- ②  Image Stabilizer



3. Use the front dial to select an option.

Still picture (S-IS)

S-IS Off (Still-I.S. Off)	Image stabilization disabled. Select this option when using a tripod.
S-IS AUTO (Auto I.S.)	Image stabilization applies to motion on all axes. If panning motion is detected, the camera will automatically suspend image stabilization on that axis.
S-IS ¹ (All Direction Shake I.S.)	Image stabilization applies to motion on all axes.
S-IS ² (Vertical Shake I.S.)	Image stabilization applies to vertical motion. Use when panning the camera horizontally.
S-IS ³ (Horizontal Shake I.S.)	Image stabilization applies to horizontal motion. Use when panning the camera vertically.

Movie (M-IS)

M-IS Off (Movie-I.S. Off)	Image stabilization disabled.
M-IS ¹ (All Direction Shake I.S.)	Electronic image stabilization combined with VCM-controlled image sensor movement.
M-IS ² (All Direction Shake I.S.)	VCM-controlled image sensor movement only.

- ⓘ Image stabilization may be unable to compensate for excessive camera motion or very slow shutter speeds. Use a tripod in these cases.
- ⓘ You may notice noise or vibration while image stabilization is in effect.
- ⓘ The setting selected with the lens image stabilization switch, if any, takes priority over that selected with the camera.
- 👉 You can choose whether image stabilization will be performed while the shutter button is pressed halfway. 🛠️ [Custom Menu](#)  [\[Half Way Rls With IS\]](#) (P. 277)
- 👉 You can prioritize lens image stabilization. 🛠️ [Custom Menu](#)  > [\[Lens I.S. Priority\]](#) (P. 277)

Using lenses not in the Micro Four Thirds/Four Thirds System family

When using lenses that are not part of the Micro Four Thirds or Four Thirds system family, you will need to specify the lens focal length.

- Highlight **[Image Stabilizer]** and press the **OK** button. Press **INFO**, choose a focal length using $\Delta \nabla \langle \rangle$, and press the **OK** button.
- Choose a focal length between 0.1 mm and 1000.0 mm.
- Choose the value that matches the one printed on the lens.

 The selected value is not reset when you select **[Reset / Custom Modes] > [Reset]** (basic) in

 [Shooting Menu 1 \(P. 204\)](#).

Performing the sequential/self-timer shooting

You can take a series of pictures by keeping the shutter button pressed all the way down. Alternatively, you can take pictures using the self-timer. Other options, including anti-shock and silent modes, are also available.  ["Performing the sequential/self-timer shooting"](#) (P. 101)

1. Press the **OK** button to display the LV super control panel.
2. Highlight the sequential shooting/self-timer icon using the Δ ∇ \triangleleft \triangleright buttons.

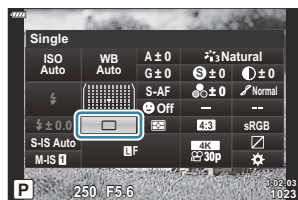

3. Use the front dial to select an option.

Setting the image aspect

Choose the ratio of width to height for pictures according to your intent or your goals for printing or the like. In addition to the standard aspect (width-to-height) ratio of **[4:3]**, the camera offers settings of **[16:9]**, **[3:2]**, **[1:1]**, and **[3:4]**.

1. Press the **OK** button to display the LV super control panel.
2. Highlight **[Aspect]** using the Δ ∇ \triangleleft \triangleright buttons.

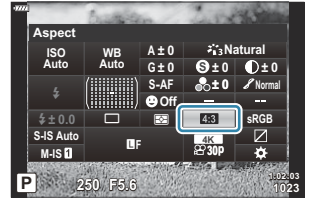

3. Use the front dial to select an option.

🔗 Image aspect can only be set for still images.

🔗 JPEG images are recorded at the selected aspect ratio. RAW images are the same size as the image sensor and are recorded at an aspect ratio of **[4:3]** with a tag indicating the aspect ratio selected. A crop indicating the selected aspect ratio is displayed when images are played back.

Photo File and Image Size Options (📷⏏️)

You can set an image quality mode for still images. Select a quality suitable for the application (such as for processing on PC, use on website etc.).

1. Press the **OK** button to display the LV super control panel.

2. Highlight [📷⏏️] using the Δ ∇ \triangleleft \triangleright buttons.



3. Use the front dial to select an option.

- Choose from the following options.

Option	Image size	Compression rate	File format
L SF	5184 × 3888	SuperFine (1/2.7)	JPG
L F	5184 × 3888	Fine (1/4)	JPG
L N	5184 × 3888	Normal (1/8)	JPG
M N	3200×2400	Normal (1/8)	JPG
RAW	5184×3888	Lossless compression	ORF
RAW+JPEG	RAW plus the JPEG option selected above		

🔗 The image size/compression combinations available can be selected in the menus.

🔗 **Custom Menu G** > [📷⏏️ **Set**] (P. 288)

🔗 The options available during high resolution shooting (P. 109) are **60M** F, **25M** F, **60M** F+RAW, and **25M** F+RAW.

🔗 Selecting High Res Shot changes the image quality option selected; be sure to check the image quality setting before shooting.

🔗 RAW images consist of unprocessed image data to which settings such as exposure compensation and white balance have yet to be applied. They serve as raw data for images that will be processed after shooting. RAW image files:

- Have the extension ".orf"
- Cannot be viewed on other cameras
- Can be viewed using OM Workspace digital photo management and editing software
- Can be saved in JPEG format using the [\[RAW Data Edit\] \(P. 250\)](#) retouch option in the camera menus

Frame Size, Rate, and Compression (📹⏪)

Choose the image quality options available for movie recording.

When choosing an option, consider how the movie will be used: for example, are you planning to process it on a computer, or is it intended for upload to a website? The camera can store multiple combinations of frame size, rate, and compression from which you can select according to your goals. Slow- and fast-motion and high-speed movie options are also available. 📖 “Filming Slow- or Fast-Motion Movies (Slow- and Fast-Motion Movies)” (P. 146) and “Filming High-Speed Movies” (P. 144)

1. Press the **OK** button to display the LV super control panel.

2. Highlight [📹⏪] using the Δ ∇ \triangleleft \triangleright buttons.



3. Use the front dial to select an option.

- To change movie record mode settings, press **OK** followed by the **INFO** button and rotate the rear dial.

The Movie Quality Icon

Changes to settings are reflected in the [🎬 ⚙️] icon as shown below.



- ① Movie Resolution
- ② Compression/Bit Rate
- ③ Frame Rate
- ④ Movie type

Movie Resolution

FHD	Full HD ¹	1920 × 1080
HD	HD ¹	1280 × 720
4K	4K ¹	3840 × 2160
C4K	4K Digital Cinema ¹	4096 × 2160

¹ Movies are saved in MPEG-4 AVC/H.264 format.

Compression/Bit Rate

ⓘ Not available when [4K] or [C4K] is selected for [Movie Resolution].

A-I	All Intra ¹
SF	Super Fine
F	Fine
N	Normal

¹ “All-Intra” movies use no inter-frame compression. This suits them to editing but increases file size.



Frame Rate

60p	60p: 59.94 fps
50p	50p: 50.00 fps
30p	30p: 29.97 fps

25p	25p: 25.00 fps
24p	24p: 23.98 fps 24p: 24.00 fps (C4K)

- **[60p]** and **[50p]** are not available when:
 - **[FHD]** (Full HD) is selected for **[Movie Resolution]** and **[A-I]** is selected for bit rate
 - **[4K]** or **[C4K]** is selected for **[Movie Resolution]**
- Selecting **[C4K]** for **[Movie Resolution]** fixes **[Frame Rate]** at **[24p]**.

Movie type

	Setting 1, 2, 3, or 4: Save up to four combinations of frame size, rate, and compression for later use.
	Custom: Choose frame sizes of 4K or 4K Digital Cinema. You can also film slow- and fast-motion Movies (P. 146).
—	High-speed movie  "Filming High-Speed Movies" (P. 144)

- ① Depending on the card used, recording may end before the maximum length is reached.
- ① Bit-rate selection may be unavailable at some settings.
- ① Movies are recorded at an aspect ratio of 16:9. C4K movies are recorded at an aspect ratio of 17:9.

Filming High-Speed Movies

Film at high frame rates. Movies are filmed at 120 fps and play back at 60 fps. Stretching playback to double the recording time (as is the case when 60p is selected as the playback frame rate) lets you view in slow motion movements that in real life took only the blink of an eye.

A high-speed movie option can be included in the movie image quality menu. Your choice of playback frame rate determines the playback speed multiplier.

Changes to settings are reflected in the movie quality icon as shown below.

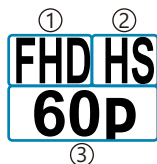

- ① Movie Resolution
- ② Movie type
- ③ Playback Frame Rate

Movie Resolution

FHD	Full HD (1920 × 1080)
-----	-----------------------

Movie type

HS	High speed (120 fps)
----	----------------------



Playback Frame Rate

60p	60p: 59.94 fps; plays back at 0.5× speed
50p	50p: 50.00 fps; plays back at 0.42× speed
30p	30p: 29.97 fps; plays back at 0.25× speed
25p	25p: 25.00 fps; plays back at 0.21× speed
24p	24p: 23.98 fps; plays back at 0.2× speed

1. Select **FHD HS 60p** (high-speed movie recording).
 - To use current settings, press the **OK** button.
The camera will exit the menu with the current options selected.
2. To edit current settings, press the **INFO** button in Step 1.
 - This places the cursor in the list of high-speed movie options.

3. Choose the playback frame rate.
 - Highlight an option using the Δ ∇ buttons.



4. Press the **OK** button to select the highlighted option and exit.

- ⓘ Focus, exposure, and white balance lock during recording.
- ⓘ Sound is not recorded.
- ⓘ The picture angle is slightly reduced.
- ⓘ Aperture, shutter speed, exposure compensation, and ISO sensitivity cannot be changed during recording.
- ⓘ Time codes cannot be recorded or displayed.
- ⓘ Brightness may change if zoom is adjusted during recording.
- ⓘ Individual movie files recorded to SD or SDHC memory cards can be up to 4 GB in size. With SDXC cards, recording will end before the movie reaches a length with a playback time of 2 hours.
- ⓘ High-speed movie recording is not available while the camera is connected to an HDMI device.
- ⓘ [ **Image Stabilizer**] > [**M-IS1**] is not available.
- ⓘ [**Movie** ] cannot be used.
- ⓘ [**i-Enhance**], [**e-Portrait**], and art filter picture modes are not available.
- ⓘ [**Gradation**] is fixed at [**Gradation Normal**].
- ⓘ High-speed movie recording is not available during remote photography when the camera is connected to a smartphone.

Filming Slow- or Fast-Motion Movies (Slow- and Fast-Motion Movies)

You can create slow motion or fast-motion movies. You can set the recording speed using  in record mode.

1. Press the **OK** button to display the LV super control panel.

2. Highlight [ ] using the Δ ∇ \triangleleft \triangleright buttons.

3. Highlight  (custom record mode; P. 142) using the front dial and press the **OK** button.

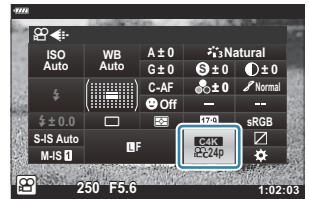

- The option selected for **[Slow or Fast Motion]** can be changed by pressing the **INFO** button. After highlighting **[Slow or Fast Motion]** using the \triangleleft \triangleright buttons, use the Δ ∇ buttons to choose a speed multiplier and then press the **OK** button. Choose high multipliers for fast-motion movies, low multipliers for slow-motion movies. The frame rate changes accordingly.

4. Press the  button to start shooting.

- Press the  button again to end shooting.
- The movie will be played back at a fixed speed so that it appears to be in slow motion or fast-motion.

 Sound will not be recorded.

 Any picture mode art filters will be canceled.

 Either or both of slow motion and fast-motion cannot be set for some options of [ ].

 Shutter speed is limited to values no slower than 1/24 s. The slowest speed available varies with the option selected for **[Frame Rate]**.

Using a flash (Flash photography)

When using a flash unit, you can choose the flash mode using camera controls and take pictures with the flash.

Attaching Compatible Flash Units

The methods used to attach and operate external flash units vary with the unit. See the documentation provided with the unit for details. The instructions here apply to the FL-LM3.

⚠ Confirm that both the camera and flash unit are off. Attaching or removing a flash unit while either the camera or flash unit is on could damage the equipment.

1. Remove the hot shoe cover and attach the flash.
 - Slide the flash in until the foot clicks into place at the back of the shoe.

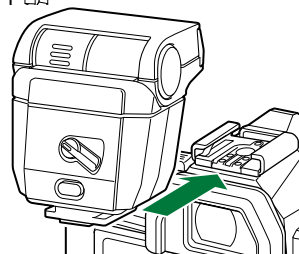
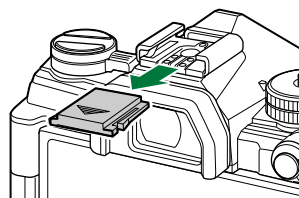

2. Position the flash head for bounce-flash photography or direct lighting.
 - The flash head can be rotated up and left or right.

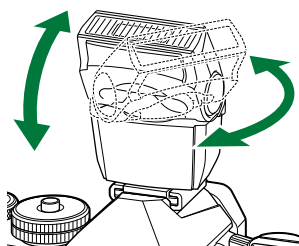

- Note that flash output may be insufficient for correct exposure when bounce flash lighting is used.

3. Rotate the flash **ON/OFF** lever to the **ON** position.



- Rotate the lever to the **OFF** position when the flash is not in use.

Removing Flash Units

1. Keeping the **UNLOCK** button pressed, slide the flash unit from the hot shoe.

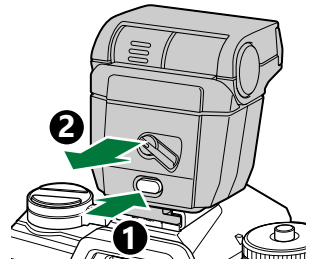

Choosing a Flash Mode (Flash Mode)

When taking pictures with a flash unit designed for use with the camera, you can select a flash mode using camera controls. Turning an attached flash unit on automatically limits the fastest available shutter speed.

1. Press the **OK** button to display the LV super control panel.
2. Highlight **[Flash Mode]** using the $\Delta \nabla \triangleleft \triangleright$ buttons.

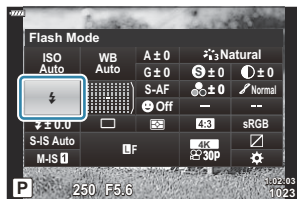



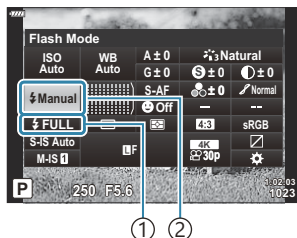















3. Use the front dial to select an option.
 - Flash settings can be accessed via the LV super control panel.





- ① Flash output (“manual value” mode)
Flash intensity control (other modes)
- ② Flash mode



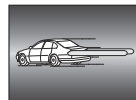

Flash Modes

	Fill In	<p>Enable the flash.</p> <p>ⓘ Shutter speed can be set to values between those selected for [ Slow Limit] and [ X-Sync.].   Custom Menu  > [ Slow Limit], [ X-Sync.] (P. 346)</p>
	Flash off	<p>Disable the flash.</p> <p>ⓘ The flash will not fire even if the unit is on.</p>
	Redeye	<p>Reduce “red-eye” in portrait photos.</p> <p>In other respects, the flash functions as it does in  (fill in) mode.</p>
	Slow Sync (front-curtain sync)	<p>Slow shutter speeds are used to capture both the main subject and the background.</p> <p>ⓘ Shutter speed is set according to the exposure value metered by the camera and is not restricted by the option selected for [ Slow Limit].</p>
	Red-Eye Slow	<p> (slow sync) combined with red-eye reduction. The flash is timed using front-curtain sync.</p>
	Slow Sync (Rear-curtain sync)	<p>As for  (slow sync).</p> <p>ⓘ The flash fires immediately before the shutter closes. Moving objects appear to leave trails of light behind them.</p>
	Manual Value	<p>The flash fires at the selected level.</p>









- ⓘ Super FP high-speed sync must be configured using flash controls.
- ⓘ In [] (red-eye reduction) mode, the shutter will be released approximately one second after the initial red-eye reduction pre-flash. Do not move the camera until shooting is complete.
- ⓘ [] (red-eye reduction) may not produce the desired results in some conditions.



Flash Mode and Shutter Speed



The range of shutter speeds available varies with the flash mode. The range of available speeds can be further restricted using the options in the  Custom Menu.   Custom Menu **F** >  **Slow Limit**,  **X-Sync.** (P. 346)

Shooting Modes P and A





LV super control panel	Flash mode	Flash timing	Shutter speed
	Fill In	Front-curtain sync	30–1/250 s
	Red-eye		
	Flash Off	—	—
	Red-eye slow	Front-curtain sync	60–1/250 s
	Slow (front-curtain sync)		
	Slow (rear-curtain sync)		
	Manual Value	Front-curtain sync	30–1/250 s

Shooting Modes S and M

LV super control panel	Flash mode	Flash timing	Shutter speed
	Fill In	Front-curtain sync	60–1/250 s
	Red-eye		
	Flash Off	—	—

LV super control panel	Flash mode	Flash timing	Shutter speed
 SLOW2	Slow (rear-curtain sync)	Rear-curtain sync	60–1/250 s
 FULL, 1/4, etc.	Manual Value	Front-curtain sync	

Shooting Mode B¹

LV super control panel	Flash mode	Flash timing	Shutter speed
	Fill In	Front-curtain sync	—
	Red-eye		
	Flash Off	—	—
 SLOW2	Slow (rear-curtain sync)	Rear-curtain sync	—
 FULL, 1/4, etc.	Manual Value	Front-curtain sync	—

¹ Rear-curtain sync is not available when **[LIVE COMP]** (P. 62) is selected.

Cautions: Flash Mode

- In red-eye reduction mode, the shutter will be released approximately one second after the initial red-eye reduction pre-flash. Do not move the camera until shooting is complete. Also note that red-eye reduction may not produce the desired results in some conditions.
- The fastest shutter speed available when the flash fires is 1/250 s. Bright backgrounds in pictures taken with the flash may be overexposed.
- The sync speed for silent photography (P. 106), High Res Shot (P. 109), and focus bracketing (P. 216) is 1/50 s. Setting **[ISO]** to a value over ISO 8000 when using an option that requires the electronic shutter (for example, silent mode or focus bracketing) sets the flash sync speed to 1/20 s. The flash sync speed for ISO bracketing (P. 216) is also 1/20 s.
- Even the minimum available flash output may be too bright at short range. To prevent overexposure in pictures taken at short range, select mode **A** or **M** and choose a smaller aperture (higher f-number) or choose a lower setting for **[ISO]**.

Adjusting flash output (Flash intensity control)

Flash output can be adjusted if you find that your subject is overexposed, or is underexposed even though the exposure in the rest of the frame is appropriate. Flash compensation is available in modes other than [**Manual**] (manual).

- When [**Manual**] is selected, you can adjust flash output by pressing ∇ to select [**Full**] and then rotating the front dial.

1. Press the **OK** button to display the LV super control panel.

2. Highlight [**Flash**] using the Δ ∇ \triangleleft \triangleright buttons.

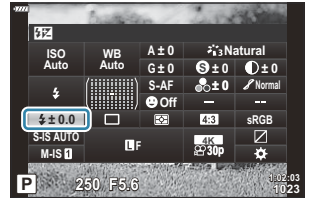













3. Use the front dial to select an option.



- Changes to flash intensity made with the external flash unit are added to those made with the camera.

Processing options (Picture Mode)

Choose how pictures are processed during shooting to enhance color, tone, and other properties. Choose from preset picture modes according to your subject or artistic intent. Contrast, sharpness, and other settings can be adjusted separately for each mode. You can also add artistic effects using art filters. Art filters give you the option of added frame effects and the like. Adjustments to individual parameters are stored separately for each picture mode and art filter.

Picture mode options

	i-Enhance	The camera adjusts colors and contrast for optimal results according to the type of subject (P. 164).
	Vivid	Choose for vivid colors.
	Natural	Choose for natural colors.
	Muted	Choose for pictures that will later be retouched.
	Portrait	Enhance skin tones.
	Monochrome	Record pictures in monochrome. You can apply color filter effects and choose a tint (P. 163).
	Custom	Adjust picture mode parameters to create a custom version of a selected picture mode.
	e-Portrait	Smooth complexions.
	Underwater	Process pictures to preserve the vivid colors seen under water. <ul style="list-style-type: none">• We recommend choosing [Off] for [+WB] in  Custom Menu [F] (P. 287) when this option is selected.
	Color Creator	Adjust hue and color to suit your creative intent (P. 157).

ART 1	Pop Art		
ART 2	Soft Focus		
ART 3	Pale&Light Color		
ART 4	Light Tone		
ART 5	Grainy Film		
ART 6	Pin Hole		
ART 7	Diorama		
ART 8	Cross Process	Uses Art Filter settings. Art effects can also be used. Available effects differ depending on the art filter.	
ART 9	Gentle Sepia		
ART 10	Dramatic Tone		
ART 11	Key Line		
ART 12	Watercolor		
ART 13	Vintage		
ART 14	Partial Color (P. 76)		
ART 15	Bleach Bypass		
ART 16	Instant Film		
 1	Flat ¹		Movies are recorded using a tone curve adapted to color grading.
 2	OM-Log400 ¹		Movies are recorded using a log tone curve for greater freedom during color grading.

¹ Displayed in movie mode when **[On]** is selected for [\[Icon\] Specification Settings](#) > [\[Icon\] Picture Mode](#) in the [\[Icon\] Video Menu](#) (P. 233).

- Art filters apply only to the JPEG copy. **[RAW+JPEG]** is automatically selected for image quality in place of **[RAW]**.

⚠ Depending on the subject, tone transitions may be ragged, the effect may be less noticeable, or the image may become more “grainy”.

🔧 You can hide or reveal picture modes using **[Picture Mode Settings]** in **⚙ Custom Menu D1** (P. 279).

1. Press the **OK** button to display the LV super control panel.

2. Highlight **[Picture Mode]** using the **△ ▽ ◀ ▶** buttons.

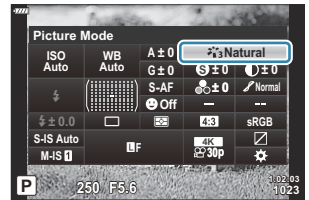

3. Use the front dial to select an option.

- Depending on the option selected, picture mode parameters may be displayed in LV super control panel. Adjust parameters as desired.
 - **🔍 Sharpness** (P. 158)
 - **🔵 Contrast** (P. 159)
 - **🌈 Saturation** (P. 160)
 - **🌀 Gradation** (P. 161)
 - **🎨 Color Filter** (P. 162)
 - **🖼 Monochrome Color** (P. 163)
 - **🎭 Effect** (P. 164)

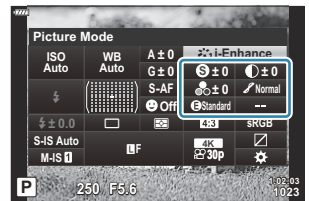

Adjusting overall color (Color Creator)

The camera permits intuitive adjustments to color saturation and hue. Choose from 30 hues and 8 levels of saturation. The results can be previewed in the display.

1. Press the **OK** button to display the LV super control panel.
2. Highlight **[Picture Mode]** using the Δ ∇ \triangleleft \triangleright buttons.
3. Rotate the front dial to highlight **[Color Creator]**.

- A **[Color/Vivid]** item will appear in the LV super control panel.

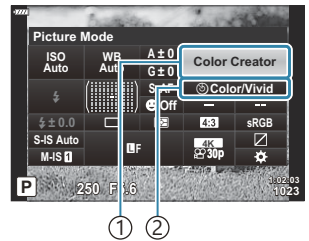

- ① Picture Mode
- ② Color/Vivid

4. Highlight **[Color/Vivid]** using the Δ ∇ buttons and press the **OK** button.

5. Adjust saturation and hue.

- Rotate the front dial to adjust hue.
- Rotate the rear dial to adjust saturation.
- To restore default settings, press and hold the **OK** button.



6. Press the **OK** button to select the highlighted option.

- You can also save changes by pressing the shutter button halfway.

- Pictures taken with **[RAW]** selected for image quality (P. 139) will be recorded at an image quality of RAW+JPEG.
- Pictures taken using **[HDR]** (P. 224) or **[Multiple Exposure]** (P. 227) are recorded at a setting of **[Natural]**.

Making fine adjustments to sharpness (Sharpness)

Adjust image sharpness. Outlines can be emphasized for a sharp, clear picture. Settings are stored separately for each picture mode.

1. Press the **OK** button to display the LV super control panel.
2. Highlight **[Sharpness]** using the $\Delta \nabla \triangleleft \triangleright$ buttons.



3. Use the front dial to select an option.

Making fine adjustments to contrast (Contrast)

Adjust image contrast. Increasing contrast heightens the difference between bright and dark areas for a harder, more well-defined picture. Settings are stored separately for each picture mode.

1. Press the **OK** button to display the LV super control panel.
2. Highlight **[Contrast]** using the $\Delta \nabla \triangleleft \triangleright$ buttons.

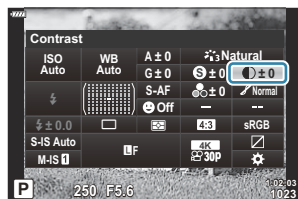

3. Use the front dial to select an option.

Making fine adjustments to saturation (Saturation)

Adjust color saturation. Increasing saturation makes pictures more vivid. Settings are stored separately for each picture mode.

1. Press the **OK** button to display the LV super control panel.
2. Highlight **[Saturation]** using the Δ ∇ \triangleleft \triangleright buttons.

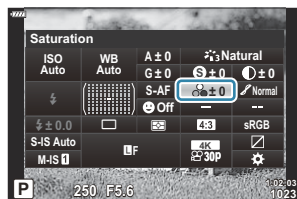

3. Use the front dial to select an option.



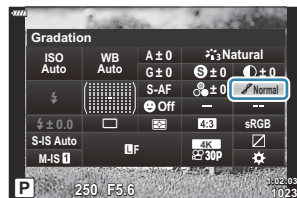

Making fine adjustments to tone (Gradation)

Adjust shading and color brightness. You can brighten or darken the entire picture to bring it closer to what you envisage. The difference in contrast can be adjusted to capture details in both shadows and highlights. Settings are stored separately for each picture mode.

1. Press the **OK** button to display the LV super control panel.
2. Highlight **[Gradation]** using the $\Delta \nabla \langle \rangle$ buttons.



3. Use the front dial to select an option.

 Auto	Shadow Adj	Divides the image into detailed regions and adjusts the brightness separately for each region. This is effective for images with areas of large contrast in which the whites appear too bright or the blacks appear too dark.
 Normal	Gradation Normal	Optimal shading. Recommended in most circumstances.
 High	Gradation High Key	Uses a tone suitable for a bright subject.
 Low	Gradation Low Key	Uses a tone suitable for a dark subject.

Applying filter effects to monochrome pictures (Color Filter)

Color filter effects can be added when **[Monochrome]** is selected for picture mode (P. 154). Depending on the color of the subject, color filter effects can make subjects brighter or enhance contrast. Orange adds more contrast than yellow, red more contrast than orange. Green is a good choice for portraits and the like.

1. Press the **OK** button to display the LV super control panel.
2. Highlight **[Picture Mode]** using the $\Delta \nabla \triangleleft \triangleright$ buttons.
3. Select **[Monochrome]** using the front dial.
4. Highlight **[Color Filter]** using the $\Delta \nabla \triangleleft \triangleright$ buttons.

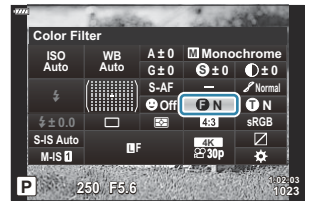

5. Use the front dial to select an option.

N	N:None	No filter effect.
Ye	Ye:Yellow	Reproduces clearly defined white cloud with natural blue sky.
Or	Or:Orange	Slightly brings out blue skies or the light of the setting sun.
R	R:Red	Further brings out blue skies or autumn foliage.
G	G:Green	Adds warmth to skin tones in portraits. The green filter also emphasizes the reds in lipstick.

Adjusting the tone of a monochrome image (Monochrome Color)

Choose the tint used for pictures taken with **[Monochrome]** selected for picture mode (P. 154).

1. Press the **OK** button to display the LV super control panel.
2. Highlight **[Picture Mode]** using the $\Delta \nabla \triangleleft \triangleright$ buttons.
3. Select **[Monochrome]** using the front dial.
4. Highlight **[Monochrome Color]** using the $\Delta \nabla \triangleleft \triangleright$ buttons.

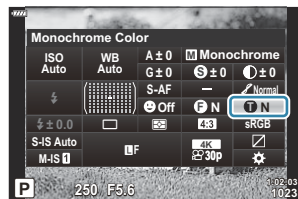

5. Use the front dial to select an option.

N	N:Normal	Creates a normal black and white image.
S	S:Sepia	Shoot in sepia-tinted monochrome.
B	B:Blue	Shoot in blue-tinted monochrome.
P	P:Purple	Shoot in purple-tinted monochrome.
G	G:Green	Shoot in green-tinted monochrome.

Adjusting i-Enhance effects (Effect)

Choose the strength of the i-Enhance effect when **[i-Enhance]** is selected for picture mode (P. 154).

1. Press the **OK** button to display the LV super control panel.
2. Highlight **[Effect]** using the Δ ∇ \triangleleft \triangleright buttons.



3. Use the front dial to select an option.

E Low	Effect: Low	Adds a low i-Enhance effect to images.
E Standard	Effect: Standard	Adds an i-Enhance effect between “low” and “high” to images.
E High	Effect: High	Adds a high i-Enhance effect to images.

Setting the color reproduction format (Color Space)

You can select a format to ensure that colors are correctly reproduced when shot images are regenerated on a monitor or using a printer. This option is equivalent to the [\[Color Space\]](#) in [Custom Menu G \(P. 288\)](#).

1. Press the **OK** button to display the LV super control panel.
2. Highlight **[Color Space]** using the Δ ∇ \triangleleft \triangleright buttons.

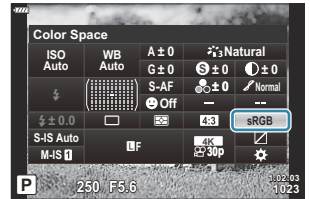

3. Use the front dial to select an option.

sRGB	The color space standardized by an international standards organization. It is widely supported across displays, printers, digital cameras, and computer applications. This setting is recommended in most circumstances.
AdobeRGB	It can reproduce a wider gamut of colors than sRGB. Accurate color reproduction is available only with software and devices (displays, printers, and the like) that support this standard. An underscore (“_”) appears at the beginning of the file name (e.g., “_xxx0000.jpg”).

[AdobeRGB] is not available in **AUTO, SCN, ART**, HDR, or movie () mode.

Changing the brightness of highlights and shadows (Highlight&Shadow Control)

Adjust brightness separately for highlights, mid-tones, and shadows. You gain greater control over exposure than you would with exposure compensation alone. You can selectively make highlights darker or shadows brighter.

1. Press the **OK** button to display the LV super control panel.
2. Highlight **[Highlight&Shadow Control]** using the $\Delta \nabla \triangleleft \triangleright$ buttons and press the **OK** button.

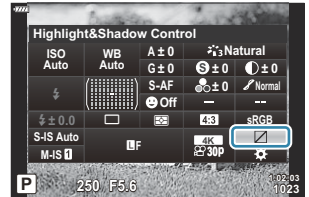

3. Press the **INFO** button to choose the desired tone range.
 - The tone range changes each time the button is pressed.

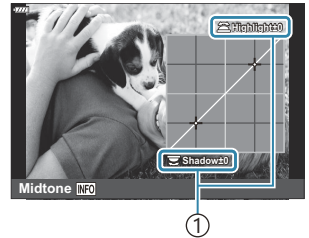

① Selected tone range

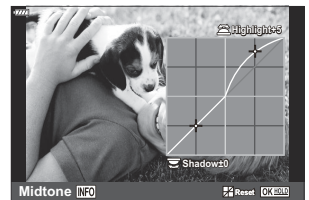

4. Rotate the dials to choose the desired setting.
 - **[Hi. & Sh.]** selected
Adjust highlights using the front dial and shadows using the rear dial.
 - **[Midtone]** selected
Use the front or rear dial.
 - To reset highlight and shadow control, press and hold the **OK** button.

































5. Press the **OK** button to select the highlighted option.
 - You can also save changes by pressing the shutter button halfway.

Assigning functions to buttons (Button Function)

Other roles can be assigned to buttons in place of their existing functions.

The functions assigned using [ **Button Function**] take effect only during still photography. The functions assigned using [ **Button Function**] take effect in  (movie) mode.

Customizable Controls

Icon	Button	Default role	
			
	 button	 (sequential shooting/self-timer)	Off
	 button	 (display selection)	
	 button	 (exposure compensation)	
	 button	 REC (movie recording)	
	AEL/AFL button	 (exposure/focus lock)	
	ISO button	ISO sensitivity	
	Arrow pad ¹	 (AF-target position)	
	Arrow pad  (right) ²	 (flash)	Electronic zoom ⁴
	Arrow pad  (down) ²	 (sequential shooting/self-timer)	WB (white balance)
	 button	 (preview)	 (magnify)
	Lens Fn button ³	AF stop	

- 1 To use the $\Delta \nabla \triangleleft \triangleright$ buttons in their assigned roles, select **[Direct Function]** for $\diamond \blacktriangleright$.
- 2 To use **[▶ Function]** and **[▼ Function]** options, you will first have to select **[Direct Function]** for **[◊ Function]**.
- 3 The **L-Fn** button can be used for the functions available on some lenses.
- 4 Only available with power zoom lenses.

To change the function assigned to a button, follow the steps below.

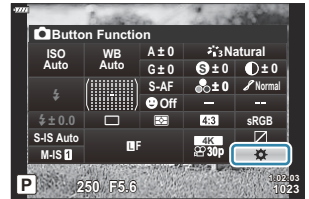

1. Press the **OK** button to display the LV super control panel.
2. Highlight **[📷 Button Function]** or **[🔧 Button Function]** using the $\Delta \nabla \triangleleft \triangleright$ buttons and press the **OK** button.





- **[📷 Button Function]** of Custom Menu is displayed in still image shooting mode, and **[🔧 Button Function]** of **[🔧 Button/Dial/Lever]** is displayed in movie mode.

















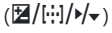





3. Highlight the desired control using the $\Delta \nabla$ buttons and press the \triangleright button.
4. Highlight a function using the $\Delta \nabla$ buttons and press the **OK** button to assign it to the selected control.









Available Roles





















 only: Can only be assigned using [ **Button Function**].









 only: Can only be assigned using [ **Button Function**].













 The options available vary from button to button.























Role	Function
AF Stop (AF Stop)	Suspend autofocus. Focus locks and autofocus is suspended while the control is pressed. Applies only to lens  buttons.
AEL/AFL ()	Lock focus and/or exposure. When used for exposure lock, the control locks exposure when pressed and releases the lock when pressed a second time. The behavior of the control can be selected using [ AEL/AFL] in  Custom Menu  (P. 299).
 REC (movie recording)	The control functions as a movie-record button. Press to start or stop recording.
Direct Function ()	Assign roles to the buttons on the arrow pad (). The following roles can be assigned:  button:  (AF-target selection)  button:  (exposure compensation)  button:  (flash) (still picture)/electronic zoom (movie)  button:  (drive mode) (still picture)/WB (movie) <ul style="list-style-type: none"> The  and  buttons can be assigned other functions if desired.
Preview () ( only)	Stop aperture down to the selected value. This lets you preview depth of field. Aperture stops down to the currently-selected value while the button is pressed. Preview options can be selected using [ Settings] in  Custom Menu  (P. 280).





















Role	Function
 (one-touch white balance)	<p>Measure a value for one-touch white balance (P. 131).</p> <p>During still photography, one-touch white balance can be measured by holding the control and pressing the shutter button while framing a reference object (a piece of white paper or the like) in the display. A list of one-touch white balance options will be displayed, from which you can choose the location to which the new value will be saved.</p> <p>When filming movies, you can measure one-touch white balance by pressing the control while framing a reference object (a piece of white paper or the like) in the display. A list of one-touch white balance options will be displayed, from which you can choose the location to which the new value will be saved.</p>
AF-Area Select ([::~]) (AF-target selection)	<p>Choose the AF-target mode (P. 91) and position the AF target (P. 95). Press the control to view the AF-target selection display. Use the front or rear dial to choose the AF-target mode and the arrow pad to position the AF target.</p> <ul style="list-style-type: none"> You can choose the controls used.   Custom Menu A2 [[::~] Select Screen Settings] (P. 307)
[[::~] Home ([::~]  (AF home position) ( only)	<p>Recall previously-saved [AF Mode], [AF Target Mode], and [AF Target Point] “home position” settings. Press the control to recall saved settings and press it again to restore the settings previously in effect. Home position settings are saved using [[::~] Set Home] in  Custom Menu A2 (P. 271).</p> <ul style="list-style-type: none"> Separate home positions can be saved for use when shooting in portrait (“tall”) and landscape (“wide”) orientations.   Custom Menu A2 [📷 Orientation Linked [[::~]]] (P. 310)
MF (AF/MF toggle)	<p>Switch between AF and MF. Press once to select MF and again to return to the previous mode. The focus mode can also be selected by holding the button and rotating a dial.</p> <p>This option will have no effect during still photography if [mode2] is selected for [📷 Fn Lever Function] (P. 321).</p> <p>It will likewise have no effect during movie recording if [mode2] is selected for [🎞 Button/Dial/Lever] > [🎞 Fn Lever Function] in the 🎞 Video Menu (P. 233).</p>

Role	Function
RAW  (RAW quality)  only)	Switch between RAW + JPEG and JPEG [] settings. Press the control to switch from RAW or JPEG to RAW + JPEG or from RAW + JPEG to JPEG. You can also choose an image quality setting by holding the button and rotating a dial.
Test Picture  TEST)  only)	Take a test shot. You can view the effects of selected settings in an actual photograph. If you keep the control pressed while pressing the shutter button, you will be able to view the results but the picture will not be saved to the memory card.
Custom Mode C—Custom Mode C4 (C—C4)  only)	Recall settings for the selected custom mode. Press the control once to recall saved settings (P. 77), a second time to restore the settings previously in effect. The control continues to perform this function when a custom mode is selected with the mode dial.
Exposure  (exposure)	Adjust exposure settings. Hold the control and rotate the front or rear dial. Alternatively, you can press the button to activate settings and then rotate the dials. The adjustments available vary with the shooting mode: [P]: Use the front or rear dial or  buttons for exposure compensation. Use the  buttons for program shift. [A]: Use the front or rear dial or  buttons for exposure compensation. Use the  buttons for aperture. [S]: Use the front or rear dial or  buttons for exposure compensation. Use the  buttons for shutter speed. [M]¹: Use the rear dial or  button for shutter speed. Use the front dial or  buttons for aperture. [B]: Use rear dial or  buttons to switch between bulb/time and live composite photography. Use the front dial or  buttons for aperture. 1 For information on adjusting exposure settings when [AUTO] is selected for [ISO] (P. 98, P. 117), see “Adjusting Exposure Compensation” (P. 90).
Digital Tele-converter 	Turn the digital teleconverter on or off (P. 208). Press once to zoom in and again to zoom out.
Keystone Comp. ()  only)	Press the control to view keystone compensation settings (P. 230). After adjusting settings, press the control again to exit. To cancel keystone compensation, press and hold the control.

Role	Function
Fisheye Compensation  (camera only)	Press the control once to enable fisheye compensation (P. 353) and again to disable. Hold the button and rotate the front or rear dial to choose from [Angle] options 1, 2, and 3.
Magnify 	Press the control once to display the zoom frame and again to zoom in (P. 96). Press the control a third time to exit zoom; to hide the zoom frame, press and hold the control. Use touch controls or $\Delta \nabla \triangleleft \triangleright$ buttons to position the zoom frame.
HDR  (camera only)	Press the control once to enable HDR (P. 224) and again to disable. Hold the button and rotate the front or rear dial to adjust [HDR] settings, including HDR bracketing.
BKT  (camera only)	Press the control once to enable bracketing (P. 216) and again to disable. Hold the button and rotate the front or rear dial to adjust [Bracketing] settings.
ISO	Hold the control and rotate the front or rear dial to adjust [ISO] settings (P. 98), or press the control to activate settings and then make adjustments using the front or rear dial or $\triangleleft \triangleright$ buttons.
WB (white balance)	Hold the control and rotate the front or rear dial to adjust [WB] settings (P. 129), or press the control to activate settings and then make adjustments using the front or rear dial or $\triangleleft \triangleright$ buttons.
Multi Function (Multi Fn)	Configure the control for use as a multi-function button (P. 176). Hold the control and rotate the front or rear dial to choose the function performed. The selected function can be performed by pressing the control.
Peaking (PEAK)	Press the control once to turn peaking on and again to turn it off (P. 317). When peaking is on, peaking options (color, amount) can be displayed by pressing the INFO button.
 Level Disp  (Level gauge display)	Display the digital level gauge. The exposure bar display in the viewfinder functions as a level gauge. Press the control again to exit. This option takes effect when [Style 1] or [Style 2] is selected for [EVF Style] in  Custom Menu  (P. 349).

Role	Function
 View Selection () (display selection)	Switch between viewfinder photography and live view. If [Off] is selected for [EVF Auto Switch] in  Custom Menu 1 (P. 293), the display will switch between the viewfinder and the monitor. Press and hold the control to display [EVF Auto Switch] options.
S-OVF () ( only)	Press the control once to select [On] for [S-OVF] in  Custom Menu 1 (P. 293) and again to select [Off] .
AF Limiter (AF Limit) ( only)	Press the control once to enable [AF Limiter] (P. 312) and again to disable. Hold the button and rotate the front or rear dial to choose from three stored settings.
Preset MF (PreMF)	Toggle [AF Mode] > [Preset MF] on or off (P. 122). Press the control once to enable preset MF and again to restore the previous focus mode. Alternatively, you can choose the [AF Mode] by holding the control and rotating a dial. This option will have no effect during still photography if [mode2] is selected for [Fn Lever Function] (P. 321). It will likewise have no effect during movie recording if [mode2] is selected for [Button/Dial/Lever] > [Fn Lever Function] in the  Video Menu (P. 233).
Lens Info Settings ( Lens)	Recall previously-saved lens data (P. 348). This can be used to recall saved data for the current lens after changing lenses or the like.
IS Mode (IS)	Press the control once to select [Off] for [Image Stabilizer] and again to turn image stabilization on (P. 134). Hold the control and rotate the front or rear dial to access [Image Stabilizer] options.
Flicker Scan ()	Press the control once to turn flicker scan on (P. 343, P. 240). You can adjust shutter speed for best results while viewing banding in the display. Press the control again to display shooting information and access other settings. Press and hold the control to select [Off] for [Flicker Scan] .
Live ND Shooting () ( only)	Press the control once to enable [Live ND Shooting] (P. 213), again to disable. Hold the button and rotate the front or rear dial to choose a setting for [ND Number] .

Role	Function
 Face Selection 	<p>Select the face used for focus when the camera detects multiple portrait subjects. Pressing the control selects the face closest to the current AF target. If  (all targets) is selected for AF-target mode, pressing the button will instead select the face closest to the center of the frame. To choose a different face, hold the control and rotate the front or rear dial.</p> <p>This option can also be used during movie recording.</p>
 Face Priority 	<p>Pressing the button when an option other than [Face Priority Off] is selected for  Face Priority (P. 126) selects [Face Priority Off]; to restore the previous setting, press the button again. To change the option displayed in the  Face Priority menu, hold the button and rotate the front or rear dial.</p>
Live View Boost   only	<p>Pressing the button when [Off] is selected for [Live View Boost] in  Custom Menu D2 (P. 280) selects [On1]. If an option other than [Off] is selected, pressing the button selects [Off]; to restore the previous setting, press the button again. To choose an option for [Live View Boost], hold the button and rotate the front or rear dial.</p>
Focus Ring Lock 	<p>Press the control once to disable, and again to enable, the lens focus ring. This option is available when [S-AF MF], [C-AF MF], [MF], [C-AF+TR MF], [Pre MF], or [AF MF] is selected for [AF Mode]. The MF portion of the AF mode indicator is displayed gray while the ring is disabled.</p> <p>In the case of lenses equipped with an MF (manual focus) clutch, pressing the button has no effect when the focus ring is in the MF position (closer to the camera body).</p> <p>Focus ring lock ends when you perform an operation such as turning the camera off or attaching a different lens.</p>
Flash Mode   only	<p>Adjust flash settings (P. 149). Press once to display flash options and again select the highlighted option and exit. Use the front or rear dial or   buttons to adjust settings.</p> <ul style="list-style-type: none"> This function can be assigned to the  and  buttons only. You must first set  to [Direct Function].
 (sequential shooting/self-timer)  only	<p>Choose a drive (sequential shooting/self-timer) mode (P. 137). Press once to display drive mode options and then choose a mode using the front or rear dial or   buttons.</p>

Role	Function
 Lock () (touch control lock)	Lock touch controls. Press and hold the button once to lock touch controls and again to unlock. <ul style="list-style-type: none"> This function can be assigned to the  and  buttons only. You must first set [>] to [Direct Function].
Electronic Zoom ()	Zoom power zoom lenses in or out. After pressing the control, use the arrow pad to zoom in or out. Use the  or  button to zoom in and the  or  button to zoom out. <ul style="list-style-type: none"> This function can be assigned to the  and  buttons only. You must first set [>] to [Direct Function].
Movie () () () only)	Zoom in or out using the movie teleconverter (P. 177). Press the control once to display the zoom frame and again to zoom in. Press the control a third time to exit zoom; to hide the zoom frame, press and hold the control. Use touch controls or the arrow pad (   ) to position the zoom frame.
S-AF () only)	Press the control to focus using [S-AF] . Focus will lock while the control is pressed.
Off	The control is not used.

Using multi function options (Multi Function)

Assign multiple roles to a single button.

🔗 To use the multi function feature, you must first assign **[Multi Function]** to a camera control.

👉 “Customizable Controls” (P. 167)

Choosing a function

1. Hold the button to which **[Multi Function]** is assigned and rotate the front or rear dial.







- Rotate the dial until the desired feature is highlighted. Release the button to select the highlighted feature.

2. Press the button to which **[Multi Function]** is assigned.



3. Adjust settings.

[Multi Function] can be used to access the following features:

	Highlight & Shadow Control	Adjust brightness using the front or rear dial. Press the INFO button to choose the tone range (highlights, shadows, or mid-tones).
	Color Creator	Use the front dial to adjust hue and the rear dial to adjust saturation.
ISO	ISO	Choose a setting using the front or rear dial.
WB	WB	
	Magnify	The zoom frame will be displayed.





	Image Aspect	Choose a setting using the front or rear dial.
	S-OVF	Press the button to turn the feature on or off.
PEAK	Peaking	

- You can choose the options displayed.   Custom Menu  > **[Multi Function Settings]** (P. 279)

 During shooting, **[Highlight & Shadow Control]** can also be set by pressing the  (exposure compensation) button followed by the **INFO** button.

Adjusting Zoom During Filming (Movie)

You can zoom in on a selected area of the frame for movie recording without using lens controls. Use for instant close-ups or cuts to wider angles. Buttons or touch controls can be used to choose the zoom location and cut to close ups or wide angles during filming.





[Movie ] is a **[ Button Function]** option. It turns on or off with a button and so must be assigned to a control using **[ Button Function]**.  “Customizable Controls” (P. 167)

- This feature is not available when **[4K]** or **[C4K]** is selected for **[ ←:]]** > **[Movie Resolution]**.
- This feature cannot be used to film high-speed movies.
- This feature cannot be combined with **[Digital Tele-converter]** (P. 208).



Using **[Movie**]

- Press the button to which **[Movie **] is assigned.
 - A frame will appear in the center of the display.

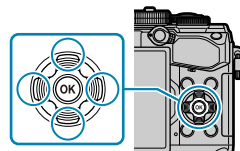

- Position the frame as desired.
 - Position the frame using touch controls or the arrow pad (   
 - To re-center the frame, press and hold the **OK** button.



3. Press the button to which **[Movie **] is assigned once more.
 - The camera will zoom the selected area in to fill the display.
 - To return to the zoom frame, press the button to which **[Movie **] is assigned a third time.

4. To end zoom, press the **OK** button once, or press and hold the button to which **[Movie **] is assigned.

Playback

Information display during playback





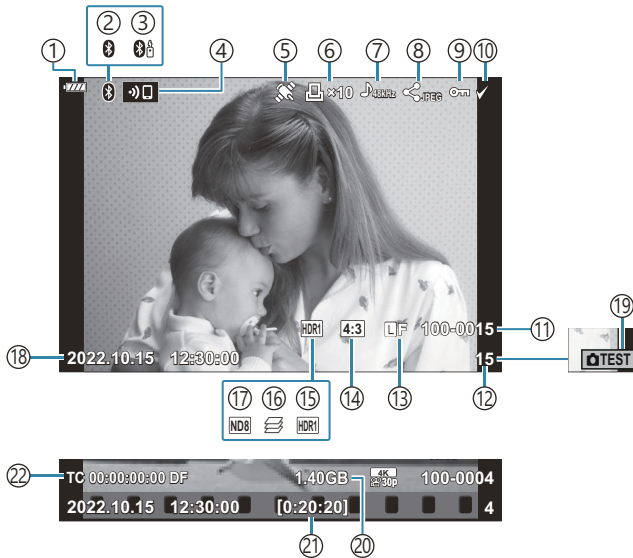

Playback image information

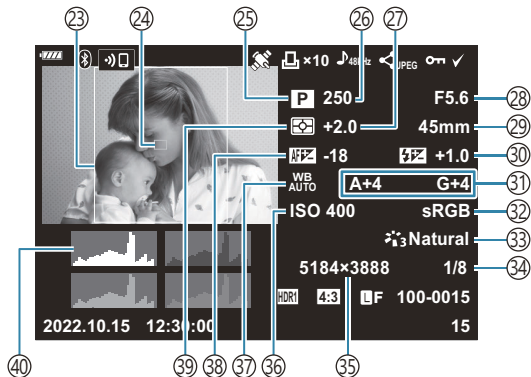
Simplified display



Overall display



- ① Battery level (P. 32)
- ② Active **Bluetooth**[®] connection (P. 359, P. 377)
- ③ Remote control (P. 377)
- ④ Wireless LAN connection (P. 359)
- ⑤ GPS data indicator (P. 368)
- ⑥ Print order
 - Number of prints (P. 193)
- ⑦ Sound record (P. 196)
- ⑧ Share order (P. 190)
- ⑨ Protect (P. 188)
- ⑩ Image selected (P. 192)
- ⑪ File number
 -   Custom Menu **[F1]** > **[File Name]** (P. 290)
- ⑫ Frame number
- ⑬ Image quality (P. 139, P. 141)
- ⑭ Aspect ratio (P. 138)
- ⑮ HDR image (P. 224)
- ⑯ Focus stacking (P. 216)
- ⑰ Live ND filter (P. 213)
- ⑱ Date and time (P. 34)
- ⑲ Test shot (P. 169)
- ⑳ Movie file size ¹ (P. 424)
- ㉑ Movie recording time ¹ (P. 424)
- ㉒ Time code ¹
 -   Video Menu >  **Display Settings** > **[Time Code Settings]** (P. 233)
- ㉓ Aspect border (P. 138)
- ㉔ AF target display (P. 123)
- ㉕ Shooting mode (P. 43)
- ㉖ Shutter speed (P. 48, P. 51, P. 53, P. 55)
- ㉗ Exposure compensation (P. 89)
- ㉘ Aperture value (P. 48, P. 51, P. 53, P. 55)
- ㉙ Focal length
- ㉚ Flash intensity control (P. 153)
- ㉛ White balance compensation (P. 133)
- ㉜ Color space (P. 165)
- ㉝ Picture mode (P. 154)
- ㉞ Compression rate (P. 347)
- ㉟ Pixel count (P. 347)
- ㊱ ISO sensitivity (P. 98, P. 117)
- ㊲ White balance (P. 129)
- ㊳ Focus adjustment
 -   Custom Menu **[A3]** > **[AF Focus Adj.]** (P. 313)
- ㊴ Metering mode (P. 124)
- ㊵ Histogram

1 Displayed only during movie playback.

Switching the information display

You can switch the information displayed during playback by pressing the **INFO** button.

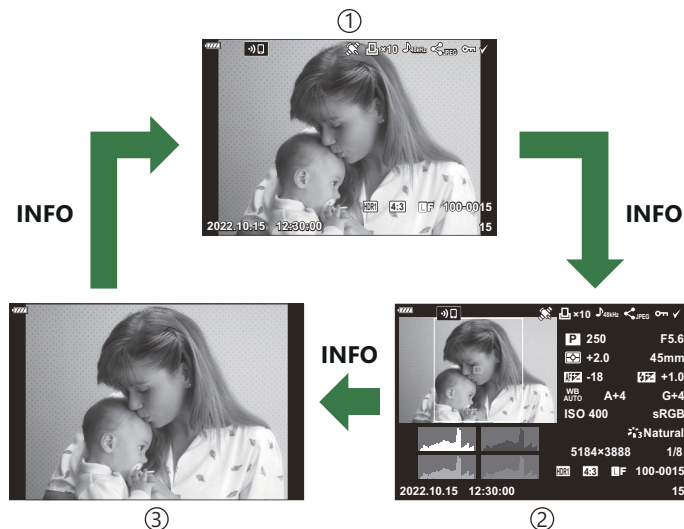
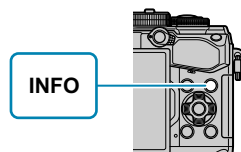



- ① Simplified display
- ② Overall display
- ③ Image only

🔗 You can add histogram and highlight-and-shadow displays to the information shown during playback. Custom Menu > /Info Settings > Info (P. 332)

Viewing photographs and movies







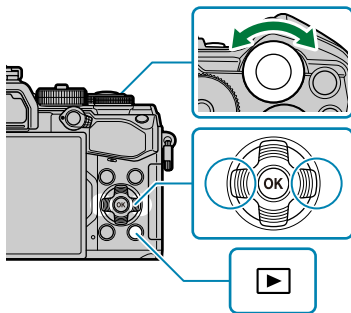









Viewing photographs

1. Press the  button.

- Your most recent photograph or movie will be displayed.
- Select the desired photograph or movie using the front dial () or arrow pad.
- Press the shutter button halfway to return to shooting mode.



Still image

Rear dial ()	Zoom in () (P. 186)/index () (P. 185)
Front dial ()	Previous () (P. 183)/next () (P. 183) Can also be used during playback zoom.
Arrow pad ()	Single-frame playback: Next () (P. 183)/previous () (P. 183)/ playback volume () (P. 197) Close-up playback (playback zoom): Scroll the picture. To display the next () or previous () frame without changing the zoom ratio, press the INFO button. Press the INFO button again to display a zoom frame and use  to change its position. Index/calendar playback: Highlight images
INFO button	View image info (P. 181)
 () button	Select image (P. 192)
 (AEL/AFL) button	Protect image (P. 188)

 button	Delete image (P. 189)
OK button	View menus (in calendar playback, press this button to exit to single-frame playback)

Watching movies







1. Press the  button.
 - Your most recent photograph or movie will be displayed.

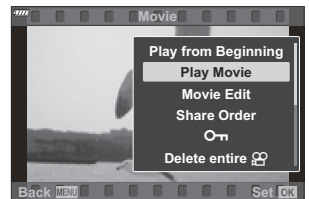

Movie



2. Select a movie and press the **OK** button.
 - The playback menu will be displayed.



3. Select **[Play Movie]** and press the **OK** button.
 - Movie playback begins.
 - Fast-forward and rewind using / .
 - Press the **OK** button again to pause playback. While playback is paused, use  to view the first frame and  to view the last frame. Use  or the front dial () to view previous or next frame.
 - Press the **MENU** button to end playback.



Viewing Large/Long Movies

Movies over 4 GB in size or two hours in length are recorded over multiple files (P. 82). The files can be played back as a single movie.

1. Press the  button.
 - The most recent picture will be displayed.
2. Display a movie file you want to view and press the **OK** button.
 - The following options will be displayed.
 - [Play from Beginning]**: Play the files back in sequence from the beginning without interruption.
 - [Play Movie]**: Play only the current file.
 - [Delete entire **]: Delete the entire movie.
 - [Erase]**: Delete only the current file.





 We recommend using the latest version of OM Workspace to play back movies on a computer (P. 373). Before launching the software for the first time, connect the camera to the computer.

Finding Pictures Quickly (Index and Calendar Playback)



- In single-frame playback, rotate the rear dial to  for index playback. Rotate further for calendar playback.
- Turn the rear dial to  to return to single-frame playback.



- ① Single-frame playback
- ② Index display
- ③ Calendar display

 You can change the number of frames for index display.  Custom Menu **D1** > /Info **Settings**] >  **Settings**] (P. 334)

Zooming In (Playback Zoom)

In single-frame playback, turn the rear dial to  to zoom in. Turn to  to return to single-frame playback.



① Single-frame playback

② 2x zoom

③ 14x zoom

④ Close-up playback

Rotating Pictures (Rotate)

Choose whether to rotate photographs.

1. Display an image you want to rotate and press the **OK** button.
2. Select **[Rotate]** and press the **OK** button.
3. Press Δ to rotate the image counterclockwise, ∇ to rotate it clockwise; the image rotates each time the button is pressed.
 - Press the **OK** button to save changes and exit.
 - Movies and protected images cannot be rotated.

 The camera can be configured to automatically rotate portrait-orientation pictures during playback.

 [Playback Menu > \[⏮\] \(P. 249\)](#)

[Rotate] is not available when **[Off]** is selected for [\[⏮\]](#).

Protecting Pictures (🔒)

Protect images from accidental deletion.

1. Display the image you want to protect and press the **🔒 (AEL/AFL)** button.

- Protected images are marked with a **🔒** (“protected”) icon.
Press the **🔒 (AEL/AFL)** button again to remove protection.



🔗 You can also protect multiple selected images. 📖 [“Selecting Multiple Pictures \(Share Order Selected, 🔒, Erase Selected\)” \(P. 192\)](#)

⚠️ Formatting the card erases all data including protected images.

- When an unprotected image is displayed, you can hold the **🔒 (AEL/AFL)** button and rotate the front or rear dial to protect all images displayed while the dial is rotated. Any previously-protected images displayed while the dial is rotated will be unaffected.
- When a protected image is displayed, you can hold the **🔒 (AEL/AFL)** button and rotate the front or rear dial to remove protection from all images displayed while the dial is rotated. Any previously-unprotected images displayed while the dial is rotated will be unaffected.
- The same operations can be performed during playback zoom or when a picture is selected in the index display.

Deleting Pictures (Erase)

1. Display an image you want to delete and press the  button.

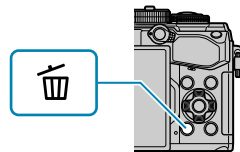

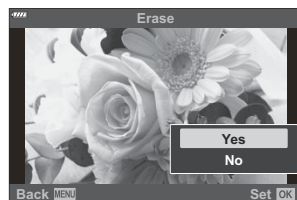

2. Highlight **[Yes]** and press the **OK** button.



- The image will be deleted.

 You can erase images without the confirmation step by changing the button settings.

  [Custom Menu H2](#) > [\[Quick Erase\]](#) (P. 292)

 You can choose whether deleting pictures recorded in RAW+JPEG image quality modes deletes both copies, only the JPEG copy, or only the RAW copy.   [Custom Menu H2](#) > [\[RAW+JPEG Erase\]](#) (P. 292)

Selecting Pictures for Sharing (Share Order)





You can select images you want to transfer to a smartphone in advance.

1. Display an image you want to transfer and press the **OK** button.
 - The playback menu will be displayed.
2. Select **[Share Order]** and press the **OK** button. Then, press Δ or ∇ .
 - The image is marked for sharing. A  icon and the file type will be displayed.
 - Up to 200 pictures can be marked for sharing at a time.
 - To cancel a share order, press Δ or ∇ .



 Movies with a file size over 4 GB cannot be marked for sharing.

 You can select images you want to transfer in advance and set a share order all at once.

 [“Selecting Multiple Pictures \(Share Order Selected, !\[\]\(e06a1d39938b2f5d7a2c3618fea4f77f_img.jpg\) Erase Selected\)” \(P. 192\), “Transferring images to a smartphone” \(P. 364\)](#)

 You can also mark images for sharing by assigning  to a button in **[  Function]**.

  **Custom Menu B** > **[  Function]** (P. 275)

- Press the  button when an unmarked image is displayed during single frame display/index display/playback zoom.
- Keep the  button pressed and rotate the front or rear dial to mark for sharing all images displayed while the dial is rotated. Any previously-marked images displayed while the dial is rotated will be unaffected.
- When a marked image is displayed, you can hold the  button and rotate the front or rear dial to remove share marking from all images displayed while the dial is rotated. Any unmarked images displayed while the dial is rotated will be unaffected.

Selecting RAW+JPEG Pictures for Sharing

In the case of pictures recorded with **[RAW+JPEG]** for image quality, you can choose to share only the JPEG copies, only the RAW copies, or both the JPEG and RAW copies.

1. Press the **MENU** button to view the menus.
2. Select **[Wi-Fi/Bluetooth Settings]** in the  Setup Menu and press \triangleright .

3. Highlight **[RAW+JPEG ↩]** using Δ ∇ and press \triangleright .

4. Highlight an option using the Δ ∇ buttons and press the **OK** button.



JPEG	Only the JPEG copies will be marked for sharing.
RAW	Only the RAW copies will be marked for sharing.
RAW+JPEG	Both RAW and JPEG copies will be marked for sharing.

ⓘ Changing the option selected for **[RAW+JPEG ↩]** does not affect pictures already marked for sharing.

ⓘ Regardless of the option selected, removing share marking removes the marking from both copies.

Selecting Multiple Pictures (Share Order Selected, , Erase Selected)





You can select multiple images for **[Share Order Selected]**, **[**], or **[Erase Selected]**.

1. Select pictures by pressing the  () button during playback.

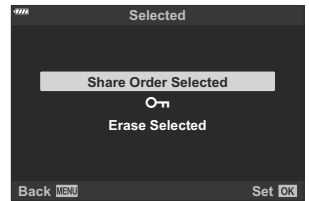
- The image will be selected and  will be displayed.
To cancel selection, press the button again.
- You can select an image during single-frame playback and index playback.

2. Press the **OK** button to display the menus and choose **[Share Order Selected]**, **[**], or **[Erase Selected]**.





- When an unmarked image is displayed, you can hold the  () button and rotate the front or rear dial to select all images displayed while the dial is rotated. Any previously-marked images displayed while the dial is rotated will be unaffected.
- When a marked image is displayed, you can hold the  () button and rotate the front or rear dial to deselect all images displayed while the dial is rotated. Any previously-unmarked images displayed while the dial is rotated will be unaffected.

Print order (DPOF)

You can save digital "print orders" to the memory card listing the pictures to be printed and the number of copies of each print. You can then have the pictures printed at a print shop that supports DPOF. A memory card is required when creating a print order.

Creating a print order

1. Press the **OK** button during playback and select **[Print Order]**.
2. Select **[**] or **[ALL]** and press the **OK** button.

Individual pictures

Press **<D>** to select a frame you want to add to the print order and then press **Δ ▽** to choose the number of prints.

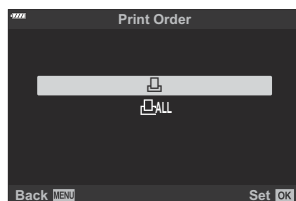

- Repeat this step as desired to add more more pictures to the print order. Press the **OK** button when all the desired pictures have been selected.

All pictures

Select **[ALL]** and press the **OK** button.

3. Select the date and time format and press the **OK** button.



No	The pictures are printed without the date and time.
Date	The pictures are printed with the shooting date.
Time	The pictures are printed with the shooting time.

ⓘ When printing images, the setting cannot be changed between the images.

4. Select **[Set]** and press the **OK** button.

- The setting will be applied to the images saved on the card being used for playback.

ⓘ The camera cannot be used to modify print orders created with other devices. Creating a new print order deletes any existing print orders created with other devices.

ⓘ Print orders cannot include RAW images or movies.

Removing all or selected pictures from the print order

You can reset all print reservation data or just the data for selected pictures.

1. Press the **OK** button during playback and select **[Print Order]** (Print Order).

2. Select **[]** and press the **OK** button.

- To remove all pictures from the print order, select **[Reset]** and press the **OK** button. To exit without removing all pictures, select **[Keep]** and press the **OK** button.
- You can also remove all pictures from the print order by selecting **[]ALL** and choosing **[Reset]**.

3. Press <|> to select images you wish to remove from the print order.
 - Use ▾ to set the number of prints to 0. Press the **OK** button once you have removed all the desired pictures from the print order.

4. Select the date and time format and press the **OK** button.
 - This setting is applied to all frames with print reservation data.
 - The setting will be applied to the images saved on the card being used for playback.

5. Select **[Set]** and press the **OK** button.

Adding Audio to Pictures (🎤)

You can record audio using the built-in stereo microphone or an optional external microphone and add it to pictures. The recorded audio provides a simple replacement for written notes about the pictures. Audio recordings can be up to 30 s long.

1. Display the image to which you want to add audio and press the **OK** button.
 - Audio recording is not available with protected images.
 - Audio can also be added to pictures using the **[Edit]** option in the playback menu. Use **[Edit]** > **[Sel. Image]** to select the picture, then press the **OK** button and select **[🎤]**.

2. Select **[🎤]** and press the **OK** button.

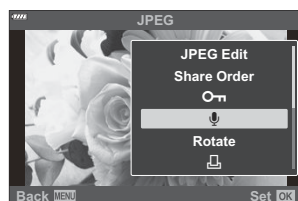

- To exit without adding audio, select **[No]**.

3. Select **[🎤 Start]** and press the **OK** button to begin recording.

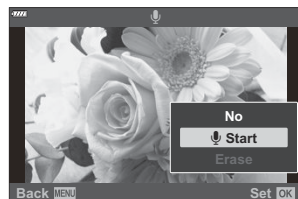

4. Press the **OK** button to end recording.
 - Pictures with audio are indicated by 🎵 icons and indicators showing the recording rate.
 - To delete recorded audio, select **[Eraser]** in Step 3.

🔊 Audio is recorded at the rate selected for movies. The rate can be selected using **[Movie 🎤]** in the **[📺 Video Menu (P. 246)]**.

Audio Playback

Playback begins automatically when a picture with audio is displayed. To adjust the volume:

1. Display the picture whose audio you want to play back.
2. Press Δ or ∇ on the arrow pad.
 - Δ button: Raise volume.
 - ∇ button: Lower volume.



Playback Using Touch Controls

Use touch controls to zoom pictures in and out, scroll pictures, or choose the picture displayed.

- ⚠ Do not tap the display with your fingernails or other sharp objects.
- ⚠ Gloves or monitor covers may interfere with touch screen operation.

Full-Frame Playback

Displaying the previous or next image

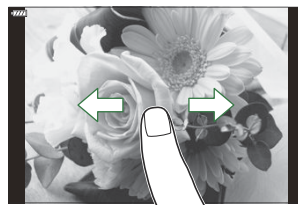

- Slide your finger to the left to view the next image, and right to view the previous image.

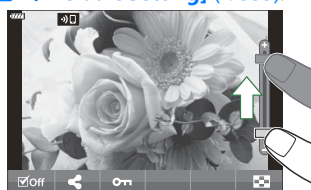

Magnify

- Lightly tap the screen to display the slider and .
- Lightly tap the display twice to zoom in to the ratio selected for [\[▶ 🔍 Default Setting\] \(P. 335\)](#).
- Slide the bar up or down to zoom in or out.



- Slide your finger to scroll the display when the picture is zoomed in.
- Tap  to display index playback. Tap  for calendar playback.

Index/Calendar Playback

Displaying the previous or next page

- Slide your finger up to view the next page, and down to view the previous page.

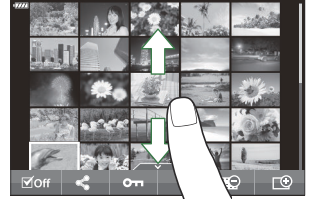

- Tap or to switch the number of images displayed. [Custom Menu D1](#) > [\[Info Settings\]](#) > [\[Settings\]](#) (P. 334)
- Tap several times to return to single-frame playback.

Viewing images

- Tap an image to view it full frame.

Other Functions







Lightly tap the screen during single-frame playback or tap during index playback to display the touch menu. You can then perform the desired operation by tapping the icons in the touch menu.

	Select an image. You can select multiple images and delete them collectively.
	Images you want to share with a smartphone can be set. "Selecting Pictures for Sharing (Share Order)" (P. 190)
	Protects an image.

Menu Functions

Basic menu operations

The menus contain shooting and playback options that are not displayed by the LV super control panel, etc., and let you customize the camera settings for easier use.

Tab	Tab name	Description
	Shooting Menu 1	Photography-related items. Ready the camera for shooting or access basic photo settings.
	Shooting Menu 2	Photography-related items. Adjust advanced photo settings.
	Video Menu	Items related to movie recording. Adjust basic and custom settings.
	Playback Menu	Playback- and retouch-related items.
	Custom Menu	Items for customizing the camera.
	Setup Menu	Items for setting the clock, choosing a language, and the like.
	My Menu	A customizable menu containing only items you select.

- “My Menu” contains no items at shipment. Use “My Menu” to store and organize frequently-used items from other menus. Select items for addition to “My Menu” from the camera menus ([P. 266](#)).

1. Press the **MENU** button to view the menus.

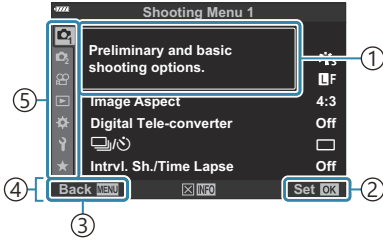

- ① Guide
- ② Press the **OK** button to confirm the setting
- ③ Press the **MENU** button to go back one screen
- ④ Operation guide
- ⑤ Tab

- A guide is displayed about 2 seconds after you select an option. Press the **INFO** button to view or hide guides.

2. Highlight a tab using the Δ ∇ buttons and press the **OK** button.

- Menu group tabs appear when Custom Menu is selected. Use Δ ∇ to select the menu group and press the **OK** button.

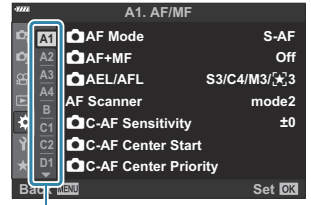

- ① Menu groups

3. Select an item using Δ ∇ and press the **OK** button to display options for the selected item.

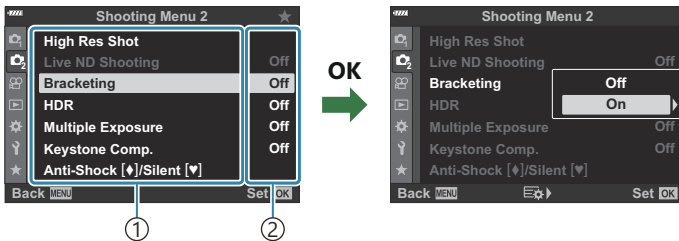

- ① Function
- ② The current setting is displayed

4. Use Δ ∇ to highlight an option and press the **OK** button to select.

- Press the **MENU** button repeatedly to exit the menu.

ⓘ Depending on camera status and settings, some items may be unavailable. Items that are not available are grayed out and cannot be selected.

🔗 For the default settings of each option, refer to [“Default Settings” \(P. 390\)](#).



🔗 You can also navigate the menus using the front and rear dials in place of the arrow pad.

Using Shooting Menu 1/Shooting Menu 2

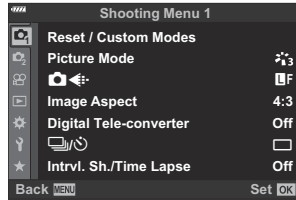

Shooting Menus 1 and 2



1 Shooting Menu 1

- Reset / Custom Modes (P. 77, P. 204)
- Picture Mode (P. 154, P. 206)
-  (P. 139, P. 207)
- Image Aspect (P. 138)
- Digital Tele-converter (P. 208)
-  /  (drive; P. 101, P. 104)
- Intrvl. Sh./Time Lapse (P. 209)

2 Shooting Menu 2

- High Res Shot (P. 212)
- Live ND Shooting (P. 213)
- Bracketing (P. 216)
- HDR (P. 224)
- Multiple Exposure (P. 227)
- Keystone Comp. (P. 230)
- Anti-Shock []/Silent [] (P. 232)

Restoring Default Settings (Reset)

Camera settings can be easily restored to default settings. You can opt to reset almost all settings or only those directly related to photography.

1. Select **[Reset / Custom Modes]** in  Shooting Menu 1 and press the **OK** button.
2. Highlight **[Reset]** and press the **▶** button.

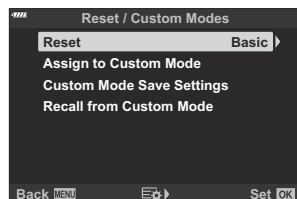

3. Highlight **[Full]** or **[Basic]**, and press the **OK** button.
 - See ["Default Settings" \(P. 390\)](#) for information on the settings that are reset.
4. Press the **OK** button in the **[Reset / Custom Modes]** menu.
5. Highlight **[Yes]** and press the **OK** button.

 Settings can be saved using OM Workspace or OM Image Share. For more information, visit our [website](#).

Saving Settings (Assign to Custom Mode)

Frequently-used settings and shooting modes can be saved to custom modes (**C** through **C4**; [P. 77](#)) and recalled for use as required simply by rotating the mode dial ([P. 79](#)). Saved settings can also be recalled directly from the menus ([P. 79](#)).

- At default settings, custom modes are equivalent to mode **P**.

Processing options (Picture Mode)

You can make individual adjustments to contrast, sharpness and other parameters via [\[Picture Mode\]](#) (P. 154) settings. Changes to parameters are stored for each picture mode separately.

1. Select **[Picture Mode]** in  Shooting Menu 1 and press the **OK** button.

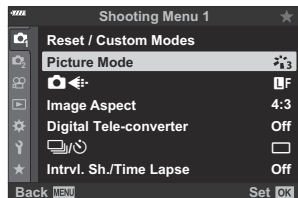

- The camera will display the picture mode available in the current shooting mode.

2. Highlight an option using the Δ ∇ buttons and press the **OK** button.

- Press \blacktriangleright to set the detailed options for the selected picture mode. Detailed options are not available for some picture modes.

 Changes to contrast have no effect at settings other than **[Standard]**.





 You can reduce the number of picture mode options displayed in the menu.   [Custom Menu](#)
 > [\[Picture Mode Settings\]](#) (P. 279)

Photo File and Image Size Options (📷 ⏪)

👉 "Photo File and Image Size Options (📷 ⏪)" (P. 139)

🔔 You can change the JPEG image size and compression ratio combination, and **[M]** and **[S]** pixel counts. 👉 "Combinations of JPEG image sizes and compression rates (⏪ Set)" (P. 347),

⚙️ Custom Menu **G** > **[Pixel Count]** (P. 288)

Digital Zoom (Digital Tele-converter)

This option takes a crop at the center of the frame the same dimensions as the size option currently selected for image quality and zooms it in to fill the display. The zoom ratio increases by about 2×. This allows you to zoom in past the maximum focal length of the lens, making it a good choice when you are unable to switch lenses or find it difficult to get any closer to your subject.

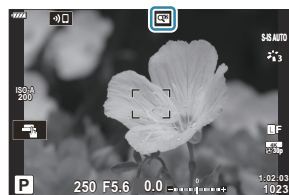

1. Select **[Digital Tele-converter]** in  Shooting Menu 1, and press the **OK** button.
2. Highlight **[On]**, and press the **OK** button.
3. Press the **MENU** button to exit the menus.

- When **[On]** is selected, the zoom ratio increases by 2× and  icon is displayed. The number of available AF targets (P. 91) decreases and their size increases.



- JPEG images are recorded at the selected zoom ratio. In the case of RAW images, a frame shows the zoom crop. A frame showing the zoom crop is displayed on the image during playback.

 The digital teleconverter cannot be used with multiple exposure, keystone compensation, fisheye correction, or the **SCN** mode panorama option.

 **[Movie]**  cannot be used with the digital teleconverter.

Shooting automatically with a fixed interval (Intrvl. Sh./Time Lapse)

You can set the camera to shoot automatically with a set time lapse. The shot frames can also be recorded as a single movie. This setting is available only in **P/A/S/M** modes.

1. Highlight **[Intrvl. Sh./Time Lapse]** in  Shooting Menu 1 and press the **OK** button.

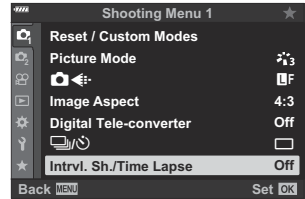



2. Highlight **[On]** and press **▷**.
3. Adjust the following settings and press the **OK** button.

Number of Frames	Choose the number of frames shot.
Start Waiting Time	Choose how long the camera waits before starting interval-timer photography and taking the first shot. [00:00:00]–[24:00:00]
Interval Length	Choose how long the camera waits between shots once shooting has begun. [00:00:01]–[24:00:00]
Interval Mode	Choose whether the camera prioritizes taking photographs at the selected interval or taking the selected number of photographs. [Time Priority]/[Frames Priority] If [Time Priority] is selected, the previous exposure may not end before the next is due to begin. The final number of photographs may be less than that chosen for [Number of Frames] if, for example, [Interval Length] is very short or shooting for each interval takes a long time to complete.

<p>Exposure Smoothing</p>	<p>Adjust exposure to average out differences between shots. This smooths exposure changes during the time-lapse movie. [Off]/[On]</p>
<p>Time Lapse Movie</p>	<p>Choose whether to record a time-lapse movie. [Off]: The camera saves the individual shots but does not use them to create a time-lapse movie. [On]: The camera records the individual shots and also uses them to create a time-lapse movie.</p>
<p>Movie Settings</p>	<p>Choose the frame size ([Movie Resolution]) and frame rate ([Frame Rate]) for movies created using [Time Lapse Movie]. The options available for [Movie Resolution] are: [4K], [FullHD], [HD] The options available for [Frame Rate] are: [30fps], [15fps], [10fps], [5fps]</p>

ⓘ The actual **[Start Waiting Time]**, **[Interval Length]** and **[Estimated Start Time]** may differ from the selected value depending on shooting settings. The values listed are for use as guidelines only.

4. Press the **OK** button repeatedly to return to  Shooting Menu 1.

- Press the **MENU** button to exit the menus.
- A  icon will appear in the shooting display (the icon shows the selected number of shots).



5. Start shooting.

- The specified number of frames will be shot automatically.

- Time lapse shooting will be canceled if any of the following is operated:
 - Mode dial, **MENU** button,  button, lens release button, or connecting the USB cable.
- Turning the camera off ends interval-timer photography.

ⓘ The  icon will turn green and the number of shots remaining will be displayed.

- ① Frames are shot even if the image is not in focus after AF. If you wish to fix the focus position, shoot in MF.
- ① The **[Image Review]** option in the **Y Setup Menu (P. 262)** functions with a display time of 0.5 seconds.
- ① If the time until shooting or the shooting interval is 1 minute 31 seconds or longer, the monitor will go dark and the camera will enter sleep mode if no operations are performed for 1 minute. The display will turn on automatically 10 seconds before shooting for the next interval begins. It can also be reactivated by pressing the shutter button at any time.
- ① The camera automatically selects **[S-AF]** for AF mode (P. 118) in place of **[C-AF]** and **[C-AF+TR]**, and **[S-AF MF]** in place of **[C-AF MF]** and **[C-AF+TR MF]**.
- ① When **[AF]** is selected as the AF mode, focus to initiate shooting, then lock focus and start recording.
- ① Touch operations are disabled during time lapse shooting.
- ① Time-lapse shooting cannot be combined with HDR photography, High Res Shot, bracketing, multiple exposure, or the live ND filter.
- ① The flash will not work if the flash charging time is longer than the interval between shots.
- ① Choosing a value over 1000 for **[Number of Frames]** selects **[Off]** for **[Time Lapse Movie]**.
- ① No time lapse movie will be created if any frame is not recorded correctly.
- ① If there is insufficient space on the card, the time lapse movie will not be recorded.
- ① If there is not enough charge left on the battery, the shooting may end partway through. Make sure the battery is charged enough before shooting.
- ① Time-lapse movies created at a size of **[4K]** may not display on some computer systems. More information is available on our website.

High Resolution Shooting Settings (High Res Shot)

Adjust High Res Shot settings (P. 109).

1. Select **[High Res Shot]** in Shooting Menu 2 and press the **OK** button.
2. Highlight an item using the Δ ∇ buttons and press the \triangleright button.
 - Highlight an option using the Δ ∇ buttons and press the **OK** button.

High Res Shot	Choose how long the camera waits to begin shooting after the shutter button is pressed all the way down. Use this option to prevent blur caused by the camera moving when the shutter button is pressed. Select [Off] to disable High Res Shot.
Charge Time	Choose how long the camera waits for the flash to charge for High Res Shots taken with the flash. You need not specify a value when using an external flash.
Shooting Method	[Tripod]: Take photos with the camera on a tripod or otherwise secured. RAW pictures are recorded at a size of 80 megapixels (10368×7776). <ul style="list-style-type: none">• The flash sync speed is 1/50 s.• The maximum value for ISO is 1600. [Handheld]: Take hand-held shots. The camera takes slightly longer to record pictures. RAW pictures are recorded at a size of 50 megapixels (8160×6120). <ul style="list-style-type: none">• The flash is disabled.• The maximum value for ISO is 6400.

- Electronic shutter is used for high resolution shooting.

Slowing the Shutter in Bright Light (Live ND Shooting)

The camera makes a series of exposures and combines to create a single photo that appears to have been taken at a slow shutter speed.

- ⓘ This option is available in modes **S** and **M**.
- ⓘ Changing exposure compensation or shutter speed resets the **[LV Simulation]** display.

1. Highlight **[Live ND Shooting]** in **C2** Shooting Menu 2 and press the **OK** button.

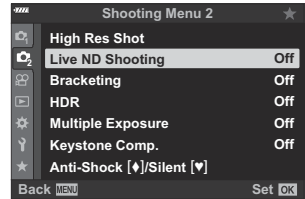

2. Highlight **[On]** using the **△** **▽** buttons and press the **▶** button.

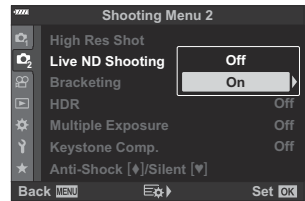

3. Highlight an option using the Δ ∇ buttons and press the \triangleright button.

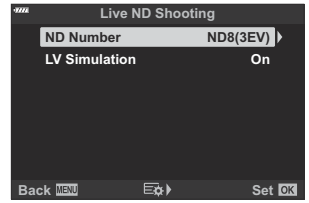

- Highlight an item using the Δ ∇ buttons and press the **OK** button.

ND Number	Choose an ND filter type; the camera will convert it to an exposure value and reduce exposure by that amount. Options are available in increments of 1 EV: [ND2 (1EV)], [ND4 (2EV)], [ND8 (3EV)], [ND16 (4EV)]
LV Simulation	Choose whether to preview the effect of the selected filter at the current shutter speed. [On]: The effects of shutter speed are shown in the display. [Off]: Use the standard shooting display.

4. To take pictures using the live ND filter, highlight **[On]** and press the **OK** button, or select **[Off]** to proceed without enabling the live ND filter.

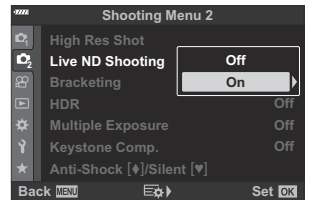

- C_2 Shooting Menu 2 will be displayed.

5. Press the **MENU** button to exit the menus.

- If you selected **[On]** for **[Live ND Shooting]**, live ND filter photography will now start.
- A ND8 icon appears in the display during live ND photography (the type of icon displayed varies with the settings selected).



- To end live ND filter photography, select **[Off]** in the **[Live ND Shooting]** display shown in Step 2.

6. Adjust shutter speed while previewing the results in the display.

- Adjust shutter speed using the rear dial.
- The slowest shutter speed available varies with the ND filter selected.
 - **[ND2 (1EV)]:** 1/30 s
 - **[ND4 (2EV)]:** 1/15 s
 - **[ND8 (3EV)]:** 1/8 s
 - **[ND16 (4EV)]:** 1/4 s



① Shutter speed

- If **[On]** is selected for **[LV Simulation]**, the effects of changes to shutter speed can be previewed in the display.

7. Take pictures.

- The camera requires a length of time equivalent to the selected shutter speed to produce **[LV Simulation]** results similar to the final image.

⚠ Art filter picture modes cannot be used.

⚠ The upper limit for **[ISO]** during live ND photography is ISO 800. This also applies when **[AUTO]** is selected for **[ISO]**.

⚠ Enabling the live ND filter sets the drive mode to **[S]**.

⚠ The following cannot be used:

- HDR, High Res Shot, multiple exposure, keystone compensation, bracketing, interval-timer photography, **[Flicker Scan]**, flickerless photography, and fisheye correction.

⚠ Unlike physical ND filters, the live ND filter does not reduce the amount of light reaching the image sensor, and consequently very bright subjects may be overexposed.

Varying settings over a series of photographs (Bracketing)

Bracketing is used to vary shooting settings such as exposure and white balance over a series of shots. Depending on the setting, you may be able to combine several different forms of bracketing. Use bracketing if you are unsure what settings to use or lack the time needed to change settings during shooting. You can also store bracketing settings and later recall them simply by turning bracketing on.

AE BKT (AE bracketing)

The camera varies the exposure of each shot. You can select the bracketing increment from 0.3 EV, 0.7 EV, and 1.0 EV. In single-frame shooting mode, one photograph is taken each time the shutter button is pressed all the way down, while in sequential shooting mode the camera continues to take shots in the following order while the shutter button is pressed all the way down: no modification, negative, positive.

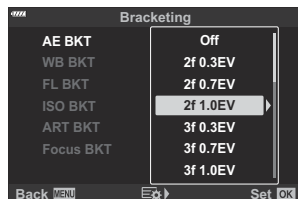

- Number of shots: Choose from 2, 3, 5, or 7.
 - A **[BKT]** icon is displayed in green until all the shots in the bracketing sequence have been taken.
 - The camera modifies exposure by varying aperture and shutter speed (mode **P**), shutter speed (mode **A**), aperture (mode **S**), or ISO sensitivity (mode **M**).
 - If an option other than **[AUTO]** is selected for **[ISO]** (P. 98, P. 117) in mode **M**, the camera will instead modify exposure by varying shutter speed.
 - The camera brackets the value currently selected for exposure compensation.
 - The size of the bracketing increment changes with the value selected for **[EV Step]** in **Custom Menu E1** (P. 284).
- ⓘ Exposure bracketing cannot be combined with FL or focus bracketing.

WB BKT (WB bracketing)

Three images with different white balances (adjusted in specified color directions) are automatically created from one shot, starting with the value currently selected for white balance.



- White balance can be varied by 2, 4, or 6 steps on each of the A – B (Amber – Blue) and G – M (Green – Magenta) axes.
- The camera brackets the value currently selected for white balance compensation.

ⓘ WB bracketing cannot be combined with ART or focus bracketing.

FL BKT (FL bracketing)

The camera varies flash level over three shots. The amount can be chosen from 0.3, 0.7, and 1.0 EV. In single-frame shooting mode, one photograph is taken each time the shutter button is pressed all the way down, while in sequential shooting mode the camera continues to take shots in the following order while the shutter button is pressed all the way down: no modification, negative, positive.

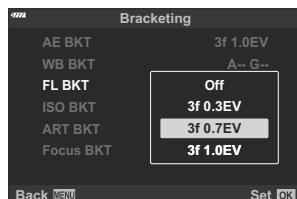

ⓘ A **BKT** icon is displayed in green until all the shots in the bracketing sequence have been taken.

- The size of the bracketing increment changes with the value selected for **[EV Step]** in **Custom Menu E1** (P. 284).

ⓘ FL bracketing cannot be combined with AE or focus bracketing.

ISO BKT (ISO bracketing)

The camera varies the sensitivity over three shots while keeping the shutter speed and aperture fixed. You can select the bracketing increment from 0.3 EV, 0.7 EV, and 1.0 EV. Each time the shutter button is pressed, the camera shoots three frames with the set sensitivity (or if auto sensitivity is selected, the optimal sensitivity setting) on the first shot, negative modification on the second shot, and positive modification on the third shot.

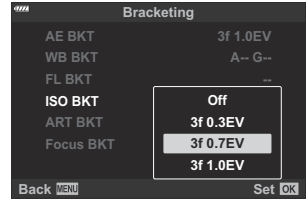

- ⓘ The size of the bracketing increment does not change with the value selected for **[ISO Step]** in **Custom Menu E1** (P. 284).
- ⓘ The upper limit selected using **[ISO-Auto Set]** in **Custom Menu E1** (P. 284) is ignored.
- ⓘ During silent photography, the flash sync speed is set to 1/20 s.
- ⓘ ISO sensitivity bracketing cannot be combined with ART or focus bracketing.

ART BKT (ART bracketing)

Create multiple copies of each picture, each with a different art filter applied. The options selected are indicated by checks (✓).

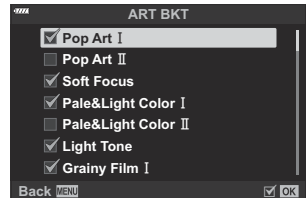

- ⓘ When there is a large number of art filters to be applied, it may take a long time to record the pictures after shooting.
- ⓘ With the exceptions of AE and FL bracketing, ART bracketing cannot be combined with other forms of bracketing.

Focus BKT (Focus bracketing)

Take a series of shots at different focus positions. Focus moves successively farther from the initial focus position.

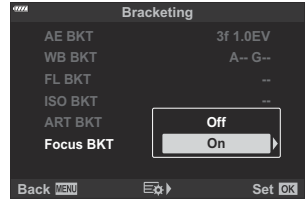

Choose the number of shots using **[Set number of shots]** and the change in focus distance using **[Set focus differential]**.



Choose smaller values for **[Set focus differential]** to narrow the change in focus distance, larger values to widen it.

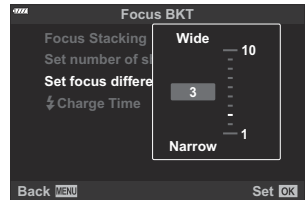

If you are using a flash other than the dedicated flash unit, you can specify the time it takes to charge using the **[Charge Time]** option.

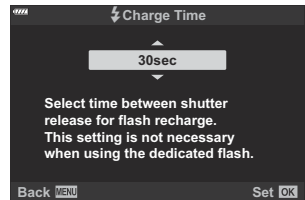

Press the shutter button all the way down and release it immediately. Shooting will continue until the selected number of shots is taken or until the shutter button is pressed all the way down again.

- ⚠ Focus bracketing is not available with lenses that have mounts conforming to the Four-Thirds standard.
- ⚠ Focus bracketing ends if zoom is adjusted during shooting.
- ⚠ Shooting ends when focus reaches infinity.
- ⚠ Pictures taken using focus bracketing are shot in silent mode.
- ⚠ Focus bracketing cannot be combined with other forms of bracketing.
- ⚠ The flash sync speed is 1/50 s. It drops to 1/20 s at **[ISO]** settings over ISO 8000.

Focus BKT (Focus Stacking)

The camera automatically shifts focus over a series of from 3 to 8 shots and combines to create a single JPEG image that is in focus all the way from the foreground to background.

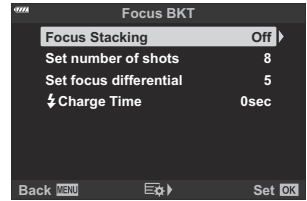

- ⓘ If focus stacking fails, the camera will record the selected number of photos without creating a composite image.
- ⓘ Shooting will end if zoom is adjusted after the shutter button has been pressed all the way down to start focus stacking photography.
- ⓘ The angle of view for composited images is narrower than the original images.
- ⓘ A frame indicating the final crop will be shown in the display.
Compose the shot with your subject in the frame.



- ⓘ The framing grid selected for **[Grid Settings] > [Displayed Grid]** in **Custom Menu D3** (P. 281) will not be displayed.
- ⓘ Pictures taken with **[e-Portrait]** or an art filter selected for picture mode are recorded in **[Natural]** mode.
- ⓘ This feature is available with compatible lenses only. Visit our website for information on compatible lenses.
- ⓘ Focus stacking cannot be combined with other forms of bracketing.

Using Bracketing

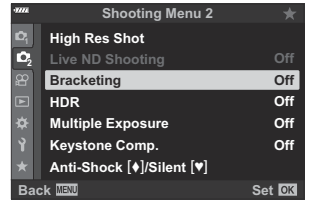

1. Highlight **[Bracketing]** in  Shooting Menu 2 and press the **OK** button.

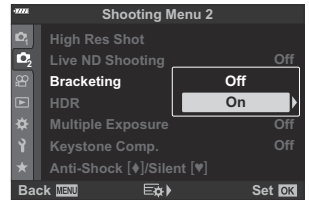

2. Highlight **[On]** and press .



- A menu of bracketing types will be displayed.

3. Highlight a bracketing type using the   buttons and press the  button.

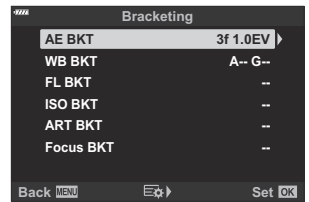

- The camera will display bracketing options for the selected bracketing type.

4. Using the Δ ∇ \triangleleft \triangleright buttons, select **[On]** or a bracketing program.

• **AE BKT**

Highlight a two-shot (2f) option and press the \triangleright button to display a menu where you can choose whether exposure will be adjusted upward or downward from the reference value. Use the Δ ∇ buttons to highlight the desired option and press the **OK** button to select the highlighted option and return to the previous display.

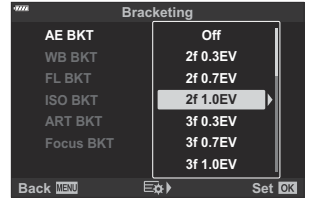

• **WB BKT**

You will be prompted to choose a color axis (A-B or G-M). Use the \triangleleft \triangleright buttons to highlight an axis and the Δ ∇ buttons to choose the bracketing amount. Press the **OK** button to return to the previous display when settings are complete.



• **ART BKT**

Highlight **[On]** and press the \triangleright button to display a menu of picture modes and art filters. Use the Δ ∇ buttons to highlight the desired filters and press the **OK** button to select (selected filters are indicated by check marks). Press the **MENU** button to return to the previous display when settings are complete.

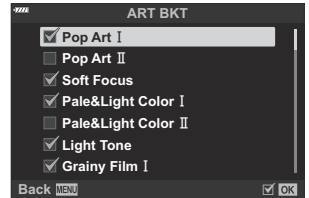

• **Focus BKT**

Highlight **[On]** and press the \triangleright button to view focus bracketing settings. Use the Δ ∇ buttons to highlight a setting and press the \triangleright button to display options. Use the Δ ∇ buttons to highlight an option and press the **OK** button to return to the setting menu. Press the **OK** button again to return to the bracketing menu when settings are complete. The **[Focus BKT]** menu is also used for **[Focus Stacking]** settings.

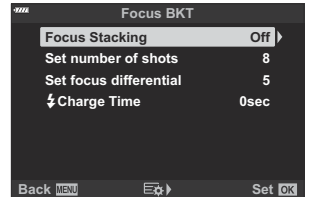

5. With **[On]** selected, press the **OK** button to save changes and exit.

6. Confirm that **[On]** is selected for **[Bracketing]** and press the **OK** button.

- To save changes without enabling bracketing, press the **MENU** button or highlight **[Off]** and press the **OK** button.

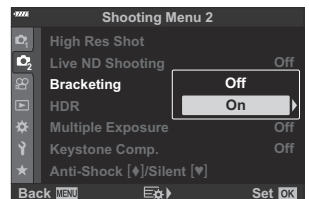

7. Take pictures.

- A **BKT** icon is displayed when bracketing is active.



- ⚠ Bracketing cannot be combined with HDR, multiple-exposure or interval-timer photography, keystone compensation, High Res Shot, fisheye compensation, or the live ND filter.
- ⚠ Bracketing is not available if there is not enough space on the camera's memory card for the selected number of frames.
- ⚠ AE, FL, and focus bracketing are not available in mode **B**.

Taking HDR (High Dynamic Range) images (HDR)

The camera varies exposure over a series of shots, selects from each tone range with the highest level of detail, and combines them to create a single picture with a wide dynamic range. If the photo features a high-contrast subject, details that would otherwise be lost in shadows or highlights will be preserved.

ⓘ Use a tripod or take similar measures to fix the camera in place.

- This option is available in **P**, **A**, **S**, and **M** modes.

1. Press the **MENU** button to view the menus.
2. Highlight **[HDR]** in  Shooting Menu 2 and press the  button.

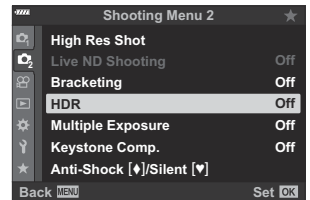

3. Highlight an option using the Δ ∇ buttons.

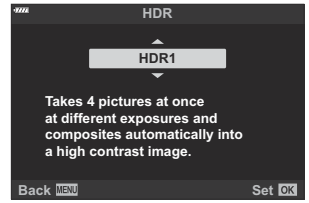

Off	HDR disabled.
HDR1	Each time you take a photo, the camera will take a series of shots while varying exposure and combine them into a single picture. Choose [HDR1] for natural-looking results, [HDR2] for a more painterly effect. <ul style="list-style-type: none"> • [ISO] is fixed at ISO 200. • Shutter speeds can be as slow as 4 s. Shooting will continue for up to 15 s. • Picture mode is fixed at [Natural] and color space at [sRGB]. • The combined picture is saved in JPEG format. When the image quality mode is set to [RAW], the image is recorded in RAW+JPEG.
HDR2	
3f 2.0EV	Each time you take a photo, the camera will vary exposure over a series of shots. The shots are not combined to create a single picture. The shots can however be combined using HDR software on a computer or other device.
5f 2.0EV	
7f 2.0EV	
3f 3.0EV	
5f 3.0EV	
	<div style="display: flex; align-items: center; justify-content: center;"> <div style="text-align: center;"> <p>3f 2.0EV</p> <p>① ②</p> </div> <div style="margin-left: 20px;"> <p>① Number of shots</p> <p>② Exposure range</p> </div> </div>

4. Press the **OK** button to select the highlighted option.

- Shooting Menu 2 will be displayed.

5. Press the **MENU** button repeatedly to exit the menu.

- The camera will exit to the shooting display. A **[HDR]** icon will be displayed.
- The drive mode will be fixed at (sequential high).



6. Take pictures.

- Each time you press the shutter button, the camera will take the selected number of shots.
- In **[HDR1]** and **[HDR2]** modes, the camera will automatically combine the shots into a single picture.
- Exposure compensation is available in modes **P**, **A**, and **S**.
- In mode **M**, the camera takes the values selected for aperture and shutter speed as a base for HDR photography.

ⓘ The image displayed in the monitor or viewfinder during shooting differs from the final HDR picture.

ⓘ Noise may appear in the final picture when a slower shutter speed is selected in **[HDR1]** or **[HDR2]** mode.

ⓘ The following cannot be used:

- flash photography, bracketing, multiple exposure, interval-timer photography, keystone compensation, the live ND filter, fisheye correction, and High Res Shot.

Recording multiple exposures in a single image (Multiple Exposure)

Take two shots and combine them into a single picture. Alternatively, you can take a shot and combine it with an existing picture stored on the memory card.

The combined image is recorded at current image quality settings. Only RAW pictures can be selected for multiple exposures that include an existing image.

If you record a multiple exposure with RAW selected for [📷🔍], you can then select it for subsequent multiple exposures using [Overlay], allowing you to create multiple exposures combining three or more photographs.

- This option is available in **P**, **A**, **S**, **M**, and **B** modes.

1. Select [Multiple Exposure] in **2** Shooting Menu 2 and press the **OK** button.

2. Highlight an item using Δ ∇ and press the \triangleright button.

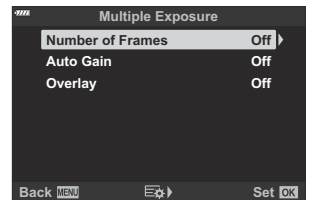

3. Highlight an option using the Δ ∇ buttons.

Number of Frames	[Off]: Do not create additional multiple exposures. [2f]: Create a multiple exposure from 2 pictures.
Auto Gain	[On]: Halve the brightness of each picture in the multiple exposure. [Off]: Do not adjust the brightness of the pictures in the multiple exposure.

Overlay

[On]: Shoot a multiple exposure that includes an existing RAW image stored on the memory card.

[Off]: Create a multiple exposure from the next 2 pictures taken.

- **[Overlay]** is only available when **[2f]** is selected for **[Number of Frames]**.
- If **[On]** is selected for **[Overlay]**, you will be prompted to choose a picture for the multiple exposure. Highlight a picture using Δ ∇ \triangleleft \triangleright and press the **OK** button.

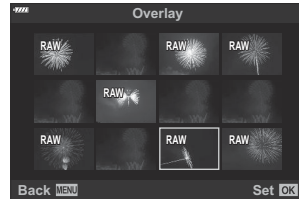





- Only RAW images can be selected.



4. Press the **OK** button.
5. Press the **OK** button in the multiple-exposure menu to save the selected settings.
 - The shooting menu will be displayed.
6. Press the **MENU** button to exit the menus.
 - A  icon will be displayed.



- If **[Overlay]** is selected, the chosen photograph will be visible superimposed on the view through the lens.

7. Take pictures.

- The first shot (or if **[Overlay]** is selected, the previously-chosen photograph) will be visible superimposed on the view through the lens as you compose the next shot.
- The  icon turns green.
- Normally, a multiple exposure will be created after the second shot is taken.
- Pressing the  button allows you to retake the first shot.
- If **[On]** is selected for **[Overlay]**, you can take additional pictures that will be overlaid on the previously-chosen photograph.
- Press the **MENU** button or press the  button to end multiple-exposure photography.
- If you end multiple-exposure photography by pressing the **MENU** button, **[Off]** will be selected for **[Number of Frames]** in the multiple-exposure menu.
- The  icon clears from the display when multiple-exposure photography ends.

- ⓘ The camera will not enter sleep mode during multiple-exposure photography.
- ⓘ Pictures taken with other cameras cannot be used for multiple exposures.
- ⓘ RAW pictures taken using High Res Shot cannot be used for multiple exposures.
- ⓘ The RAW pictures listed in the image-selection display when **[On]** is selected for **[Overlay]** are those processed using the settings in effect at the time the photograph was taken.
- ⓘ Exit multiple-exposure mode before adjusting shooting settings. Some settings cannot be adjusted while multiple-exposure mode is in effect.
- ⓘ Multiple-exposure photography will end if, after you take the first shot:
 - you turn the camera off, press the  or **MENU** button, choose a different shooting mode, connect a cable of any type, or the battery runs low.
- ⓘ The image-selection display for **[Overlay]** shows the JPEG copies of photographs taken with RAW + JPEG selected for image quality.
- ⓘ Multiple-exposure photography is not available via live composite photography (**[LIVE COMP]**) in mode **B**.
- ⓘ The following are not available in multiple-exposure mode:
 - HDR, bracketing, interval-timer photography, keystone compensation, the live ND filter, fisheye correction, and High Res Shot.
- 🔗 Pictures taken with RAW selected for  (P. 139) can also be overlaid during playback.
 - 👉 ["Combining Pictures \(Image Overlay\)" \(P. 256\)](#)

Keystone correction and perspective control (Keystone Comp.)

Keystone distortion due to the influence of lens focal length and proximity to the subject can be corrected, or enhanced to exaggerate the effects of perspective. Keystone compensation can be previewed in the monitor during shooting. The corrected image is created from a smaller crop, slightly increasing the effective zoom ratio.

- This option is available in **P**, **A**, **S**, **M**, and **B** modes.

1. Select **[Keystone Comp.]** in **C2** Shooting Menu 2, and press the **OK** button.



2. Highlight **[On]**, and press the **OK** button.

3. Press the **MENU** button to exit the menus.

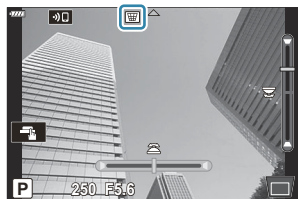
- The camera will switch to the keystone compensation display. A slider and  icon will be displayed.









4. Frame the shot and adjust keystone compensation while viewing your subject in the display.

- Rotate the front dial to make horizontal adjustments and the rear dial to make vertical adjustments.
- Frame the shot and adjust keystone compensation while viewing your subject in the display.
- Use the arrow pad () to position the crop. The direction in which the crop can be moved is shown by an arrow (.
- To cancel changes, press and hold the **OK** button.

5. To adjust aperture, shutter speed, and other shooting settings, press the **INFO** button.

- The camera will exit to the shooting display.
- A  icon is displayed while keystone compensation is enabled. The icon is displayed in green if adjustments have been made to keystone compensation settings.
- To return to the keystone compensation display shown in Step 4, press the **INFO** button repeatedly.

6. Take pictures.

- ⓘ Pictures may seem “grainy” depending on the amount of compensation performed. The amount of compensation also determines the amount the picture will be enlarged when cropped and whether the crop can be moved.
- ⓘ Depending on the amount of compensation, you may be unable to reposition the crop.
- ⓘ Depending on the amount of compensation performed, the selected AF target may not be visible in the display. If the AF target is outside the frame, its direction is indicated by a , , , or  icon in the display.
- ⓘ Pictures taken with **[RAW]** selected for image quality are recorded in RAW + JPEG format.
- ⓘ The following cannot be used:
 - live composite photography, burst photography, bracketing, HDR, multiple exposure, the live ND filter and digital teleconverter, fisheye compensation, movie recording, **[C-AF]**, **[C-AF MF]**, **[C-AF+TR]**, and **[C-AF+TR MF]** AF modes, **[e-Portrait]** and art filter picture modes, the custom self-timer, and High Res Shot.
- ⓘ Lens converters may not produce the desired results.
- ⓘ Be sure to use  **Image Stabilizer** to provide the focal lengths for lenses that are not part of the Four Thirds or Micro Four Thirds family (P. 134).
- ⓘ Where applicable, keystone compensation will be performed using the focal length supplied for  **Image Stabilizer** (P. 134) or **[Lens Info Settings]** (P. 348).

Setting anti-shock/silent shooting (Anti-Shock [♦]/Silent [♥])

Enabling anti-shock (P. 105) or silent (P. 106) shooting settings gives you a choice of options for reducing vibration or camera noise while taking photographs in sequential shooting or self-timer modes (P. 101).

1. Select **[Anti-Shock [♦]/Silent [♥]]** in  Shooting Menu 2 and press the **OK** button.
2. Highlight an item using $\Delta \nabla$ and press the \triangleright button.
3. Highlight an option using the $\Delta \nabla$ buttons.

Anti-Shock [♦]	Choose the delay between the shutter button being pressed all the way down and the shutter being released in anti-shock mode. Use this mode to suppress small vibrations caused by the operation of the shutter. Anti-shock mode is available in both sequential shooting and self-timer modes (P. 101). Select [Off] to disable anti-shock mode when it is not in use.
Silent [♥]	Choose the delay between the shutter button being pressed all the way down and the shutter being released in silent mode. Use this option in settings in which the sound of the shutter would be unwelcome. Silent mode is available in both sequential shooting and self-timer modes (P. 101). Select [Off] to disable silent mode when it is not in use.
Noise Reduction [♥]	Select [Auto] to reduce image “noise” in long exposures during silent photography. The sound of the shutter may be audible when noise reduction is active.
Silent [♥] Mode Settings	Choose whether to enable [■)]] , [AF Illuminator] , or [Flash Mode] in silent mode. Select [Allow] to use current settings for the selected item, [Not Allow] to ignore current settings and disable the selected item.

4. Press the **OK** button.

Using the Video Menu

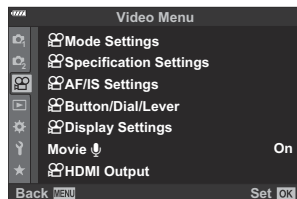

The Video Menu

Movie recording functions are set in the Video Menu.













Mode Settings







Adjust settings for movie recording.

 Mode	Choose the exposure mode for movie recording (P. 238).
 Flicker Scan	Select [On] to reduce flicker caused by LED lighting. Rotate the front or rear dial or use the Δ ∇ buttons to choose the shutter speed at which flicker reduction applies (P. 240).

Specification Settings





Adjust image quality for movies.

 	Adjust compression, frame size, and bit-rate settings for movie recording (P. 141).
  ISO-Auto Set	<p>Choose how the camera adjusts sensitivity when [AUTO] is selected for  ISO (P. 98).</p> <p>[Upper Limit / Default]: Choose the maximum and standard ISO sensitivity values available to auto ISO sensitivity control when [AUTO] is selected for  ISO in  Mode (movie exposure mode) [M].</p> <p> ISO-Auto: [AUTO] is available for  ISO when [M] is selected for  Mode (movie exposure mode). Auto ISO sensitivity control settings can be adjusted using [Upper Limit / Default].</p>

 Noise Filter	Select a noise reduction level for recording high-sensitivity movies.
 WB	Choose a white balance mode for movie recording (P. 129).
 All 	<p>Fine-tune white balance across the board (P. 133).</p> <p>[All Set]: Fine-tune white balance for all modes.</p> <p>[All Reset]: Reset fine-tuning for all modes to default values.</p>
  Keep Warm Color	Choose [On] to preserve warm colors in movies shot under incandescent lighting when [AUTO] is selected for white balance (P. 132).
 Picture Mode	Choose [On] to enable selection of a picture mode specifically for use when recording movies (P. 154).













AF/IS Settings

Choose focus and image stabilization settings for use when recording movies.

 AF Mode	Choose the AF mode for movie recording (P. 118).
 C-AF Speed	Choose how quickly the camera responds to changes to the distance to subject when [C-AF] or [C-AF+TR] is selected for focus mode.
 C-AF Sensitivity	<p>Choose how rapidly the camera responds to changes in the distance to the subject while focusing with [C-AF] or [C-AF+TR] selected for  AF Mode. This can help autofocus track a quickly-moving subject or prevent the camera refocusing when an object passes between the subject and the camera.</p> <ul style="list-style-type: none"> • Choose from three levels of tracking sensitivity. • Select +1 for increased sensitivity. Choose this option for subjects that are moving toward or away from the camera or changing speed unpredictably or for subjects that suddenly enter the frame. • Select -1 for reduced sensitivity. Choose this option to prevent the camera refocusing when the subject is briefly obscured by other objects or to prevent the camera focusing on the background when you are unable to keep the AF target positioned over a quickly-moving subject.
 Image Stabilizer	Adjust image stabilization settings for movie recording (P. 134).



Button/Dial/Lever

Choose the roles played by camera buttons, dials, and levers in movie mode.

 Button Function	Choose the roles played by camera buttons in movie mode (P. 167).
 Dial Function	Choose the roles played by front and rear dials in movie mode (P. 244).
 Fn Lever Function	Choose the functions that can be selected using the Fn lever in movie mode. The Fn lever switches to the function set with [ Dial Function] when set to [mode1]. To choose the function selected using the Fn lever, highlight [mode2], press the  button and choose from AF mode, AF target mode, and AF target selection. This setting has no effect when [mode3] is selected for [ Fn Lever Function] (P. 321) or when [Power 1] or [Power 2] is selected for [Fn Lever/Power Lever] in  Custom Menu  (P. 275).
 Shutter Function	Choose the role played by shutter button in movie mode. When set to [ , pressing the shutter button initiates autofocus. Still image photography is not available. When set to [ REC], movie recording can be started or stopped by pressing the shutter button all the way down. The  button cannot be used for starting or stopping movie recording with this setting.
 Elec. Zoom Speed	Choose the zoom speed for power zoom lenses. This can be used for slow zooms on your subject and other effects. Choose from [Low], [Normal], and [High].

Display Settings

Adjust display settings for movie mode.

 Control Settings	Choose whether live controls (P. 331) and the live super control panel (P. 111) are displayed in movie mode. To hide an item, highlight it and press the OK button to remove the check mark.
 Info Settings	Choose the information displayed during recording in movie mode. To hide an item, highlight it and press the OK button to remove the check mark.
Red Frame during 	You can opt to add a red border to the display during recording to let you know that filming is in progress.



<p>Time Code Settings</p>	<p>Choose how time codes are recorded in movie mode.</p> <p>Set [Time Code Mode] to [Drop Frame] to record time codes corrected for errors with respect to recording time, and to [Non-DF] (no drop frame) to record uncorrected time codes.</p> <p>Set [Count Up] to [Rec Run] to run time codes during recording only, and to [Free Run] to run time codes even while recording is stopped, including when the camera is turned off.</p> <p>In [Starting Time], set a starting time for the time code. Set [Current Time] to set the time code for the current frame to 00. To set to 00:00:00:00, select [Reset]. You can also set time codes using [Manual Input].</p>
<p> View Assist</p>	<p>The display can be adjusted for ease of viewing when a movie-only picture mode option ([Flat] or [OM-Log400]) is selected. Select [On] to adjust the display hues for ease of viewing.</p>

Movie

Select **[Off]** to disable audio recording during filming (P. 246).

HDMI Output

Adjust output settings for movies recorded with the camera connected with an external device via HDMI.

<p>Output Mode</p>	<p>Choose the video output mode. When set to [Monitor Mode], image and camera information are output. The camera information is not displayed on the camera screen.</p> <p>When set to [Record Mode], only image is output. The camera information is displayed on the camera screen.</p> <p> Not available when [4K] or [C4K] is selected for [Specification Setting] > [HDMI] (P. 141).</p>
<p>REC Bit</p>	<p>If set to [On], the REC trigger is sent from the camera to the connected external device.</p>
<p>Time Code</p>	<p>If set to [On], the time code is sent from the camera to the connected external device.</p> <p> External devices triggered by time codes may stop recording if:</p> <ul style="list-style-type: none"> - the footage requires extensive processing, or - you switch between the monitor and viewfinder.

Connecting HDMI Devices



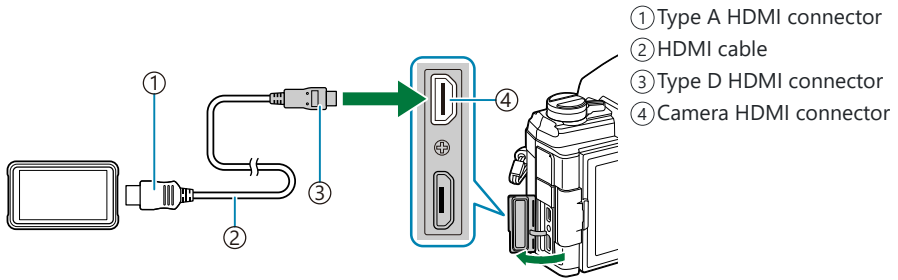



Connect the camera to the HDMI device using an HDMI cable.







- For more information, see the documentation provided with the HDMI device.

Choosing an Exposure Mode (Mode (Movie Exposure Mode))

You can create movies that take advantage of the effects available in **P**, **A**, **S**, and **M** modes. This option takes effect when the mode dial is rotated to .

1. Select [ **Mode Settings**] in  Video Menu and press the **OK** button.
2. Select [ **Mode**] (movie exposure modes) and press .
3. Highlight an option using the   buttons.

P	Optimal aperture is set automatically according to the brightness of the subject. Use the front dial or rear dial to adjust exposure compensation.
A	Depiction of background is changed by setting the aperture. Use the front dial to adjust exposure compensation and rear dial to adjust aperture.
S	Shutter speed affects how the subject appears. Use the front dial to adjust exposure compensation and rear dial to adjust shutter speed. Shutter speed can be set to values between 1/24 s and 1/32000 s.
M	Freely adjust both aperture and shutter speed. Use the front dial to select aperture value and the rear dial to select shutter speed. <ul style="list-style-type: none">• Choose from shutter speeds of 1/24 s–1/32000 s. Values of ISO 200–6400 are available using the [ ISO] manual sensitivity control options.• The display shows the difference between the exposure produced by the selected aperture and shutter speed and the optimal exposure metered by the camera. The display will flash if the difference exceeds ± 3 EV.• The option chosen for [ Specification Settings] > [ ISO-Auto Set] in the  Video Menu (P. 233) applies.

4. Press the **OK** button.





- ⚙️ Blurred frames caused by such factors as the subject moving while the shutter is open can be reduced by selecting the fastest available shutter speed.
- ⚠️ The low end of the shutter speed changes according to the frame rate of the movie record mode.

Reducing Flicker Under LED Lighting

(Flicker Scan)

Banding may occur in movies filmed under LED lighting. Use [ **Flicker Scan**] to optimize shutter speed while viewing banding in the display.

- ⓘ This option is available in [ **Mode**] (movie exposure modes) [**S**] and [**M**].
- ⓘ The range of available shutter speeds is reduced.



1. Select [**S**] or [**M**] for [ **Mode**] (movie exposure mode; P. 238).
2. Select [ **Mode Settings**] in  Video Menu and press the **OK** button.
3. Highlight [ **Flicker Scan**] and press **▷**.
4. Highlight [**On**] using the **△**/**▽** buttons and press the **OK** button.
5. Press the **MENU** button repeatedly to exit the menu.
 - A **Flicker Scan** icon is displayed when flicker scan is enabled.

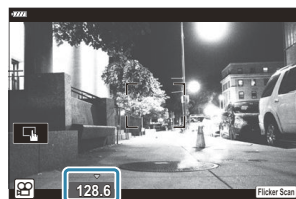

6. Choose a shutter speed while viewing the display.



① Shutter speed

- Choose a shutter speed using the front or rear dial or the Δ ∇ buttons. If desired, the shutter speed can be selected by keeping Δ ∇ pressed.
- You can also rotate the front dial to adjust shutter speed in the exposure increments selected for **[EV Step]** in  Custom Menu .
- Continue adjusting shutter speed until banding is no longer visible in the display.
- Press the **INFO** button; the display will change and the **Flicker Scan** icon will no longer be displayed. You can adjust aperture and exposure compensation. Do so using the front or rear dial or the arrow pad.
- Press the **INFO** button repeatedly to return to the flicker scan display.

7. Begin filming when settings are complete.

 Focus peaking, the LV super control panel, and live controls are not available in the flicker scan display. To view these items, first press the **INFO** button to exit the flicker scan display.

Frame Size, Rate, and Compression

Create different combinations of movie settings, including frame size and bit rate. These combinations can then be selected as described in [\(P. 141\)](#).

















1. Select [ **Specification Settings**] in the  Video Menu and press the **OK** button.
2. Select [ ] and press .
3. Highlight an item using the   buttons and press the  button.
4. Choose an option using the   buttons.



Image size	Choose from frame sizes of [C4K] (custom only), [4K] , [FHD] (Full HD), and [HD] .
Bit rate	Choose from bit rates of [A-I] (All-Intra), [SF] (Super Fine), [F] (Fine), and [N] (Normal). <ul style="list-style-type: none">• Bit-rate selection is not available when [4K] or [C4K] is selected for frame size.
Frame rate	Choose from frame rates of [60p] , [50p] , [30p] , [25p] , and [24p] . <ul style="list-style-type: none">① [60p] and [50p] are not available when:<ul style="list-style-type: none">- [FHD] (Full HD) is selected for frame size and [A-I] (All Intra) is selected for bit rate, or- [C4K] or [4K] is selected for frame size.② If the image size is set to [C4K], the frame rate is locked to 24p.③ When shooting movies that will be viewed on a television, choose a frame rate that matches the video standard used in the device, as otherwise the movie may not play back smoothly. Video standards vary by country or region: some use NTSC, others PAL. Video standards vary by country or region: some use NTSC, others PAL.<ul style="list-style-type: none">- When shooting for display on NTSC devices, choose 60p (30p)- When shooting for display on PAL devices, choose 50p (25p)
Slow or Fast Motion	Sets slow or fast motion. Available settings differ depending on the set frame rate. <ul style="list-style-type: none">• Slow and fast motions cannot be used in some image quality modes.







5. Press the **OK** button.

Assigning Roles to the Front and Rear Dials (Dial Function)

Choose the roles played by the front and rear dials in  (movie) mode. You can reverse the roles of the dials or reassign them for ease of use or as required by shooting conditions. If [**mode1**] is selected for [ **Fn Lever Function**], the roles played by the dials will vary with the position of the **Fn** lever. Different assignments can be made for each [ **Mode**] (movie exposure mode).

 The roles assigned to the dials using this item take effect in  (movie) mode. In **P**, **A**, **S**, **M**, and **B** (still photography) modes, the dials perform the roles selected in the  Custom Menu.



Role	Function	Exposure mode			
		P	A	S	M
Shutter	Choose a shutter speed.	—	—	✓	✓
FNo.	Adjust aperture.	—	✓	—	✓
	Adjust exposure compensation.	✓	✓	✓	✓
ISO	Adjust ISO sensitivity.	—	—	—	✓
WB	Adjust white balance.	✓	✓	✓	✓
CWB Kelvin	Choose a color temperature when CWB (custom) is selected for white balance.	✓	✓	✓	✓
 VOL	Adjust the recording level.	✓	✓	✓	✓
Off	None.	✓	✓	✓	✓





1. Highlight [ **Button/Dial/Lever**] in the  Video Menu and press  on the arrow pad.
2. Highlight [ **Dial Function**] using the   buttons and press the  button.

- 3.** Highlight the desired mode and press the ▷ button.
- Choose a dial using the ◀▷ buttons and use the △▽ buttons to choose a role.
 - Press the **INFO** button to move between lever positions.
 - Press the **OK** button when settings are complete.

Sound Recording Options (Movie)



Adjust settings for recording sound during filming. You can also access settings for use when an external microphone or recorder is connected.

1. Highlight **[Movie **] in  Video Menu and press the **OK** button.
2. Select **[On]** and press **▷**.
3. Highlight an item using the **△ ▽** buttons and press the **▷** button.
4. Choose a setting using the **△ ▽** buttons.

Recording Volume	Adjust microphone sensitivity. Choose separate values for the built-in stereo microphone and external microphones. [Built-In ]: Adjust the sensitivity of the camera's built-in stereo microphone. [MIC ]: Adjust the sensitivity of external microphones connected to the microphone jack.
 Volume Limiter	Choose the maximum volume at which the camera will record sound. Use this option to automatically reduce the level of sounds above a certain volume.
Wind Noise Reduction	Reduce wind noise during audio recording.
Recording Rate	Choose an audio recording format. [96kHz/24bit] : High-quality audio. [48kHz/16bit] : Standard-quality audio.
 Plug-in Power	Adjust settings for use with condenser microphones and other devices that draw power from the camera. [Off] : For devices that do not require power from the camera (general-purpose dynamic microphones). [On] : For devices that require power from the camera (condenser microphones).

5. Press the **OK** button.

 is displayed when **[Off]** is selected for movie audio recording.

 Sounds produced by the camera and lens may be audible in movies. If this is a concern, you can reduce volume of the sounds produced by the camera and lens by selecting **[S-AF]**, **[MF]**, or **[PreMF]** for  **AF Mode** (P. 118) or by using camera controls as little as possible.

 Sound is not recorded:

- with high-speed or slow- or fast-motion movies or when ^{ART}₇ (diorama) is selected for picture mode.

 Audio can only be played on devices that support the option selected for **[Recording Rate]**.

Using the Playback Menu

The Playback Menu

Playback Menu

 (P. 249)

Edit (P. 250)

Print Order (P. 193)

Reset Protect (P. 260)

Reset share Order (P. 261)

Device Connection (P. 359)

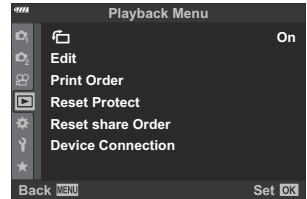

Automatically Rotating Portrait-Orientation Pictures for Playback (🔄)

If set to **[On]**, images in portrait orientation are automatically rotated to be displayed in the correct orientation on the playback display.

Retouching Pictures (Edit)

Create retouched copies of pictures. In the case of RAW pictures, you can adjust the settings in effect at the time the picture was taken, such as white balance and picture mode (art filters included). With JPEG pictures, you can make simple edits such as cropping and resizing.

RAW Data Edit	Retouch pictures and save the resulting copies in JPEG format (P. 250). The following options are available: [Current] : Save the picture at the settings currently selected with the camera. [Custom1]/[Custom2] : Adjust settings while previewing the results in the display. The settings are saved as [Custom1] or [Custom2] . [ART BKT] : The camera creates multiple JPEG copies of each image, one for each art filter selected. Select one or more filters and apply them to one or more images.
JPEG Edit	Retouch JPEG pictures and save the resulting copies in JPEG format (P. 253).

Retouching RAW Pictures (RAW Data Edit)

The **[RAW Data Edit]** menu contains the options listed below. These are also the settings applied when you select **[Current]**.

- Image quality
- Picture mode
- White balance
- Exposure compensation
- Highlights
- Shadows
- Mid-tones
- Aspect ratio
- High ISO noise reduction
- Color space
- Keystone compensation

① **[Color Space]** is fixed at **[sRGB]** when an art filter is selected for picture mode.

① RAW pictures cannot be retouched if:

- there is not enough space on the memory card or if the picture was created with a different camera.

1. Highlight **[Edit]** in the  Playback Menu and press .

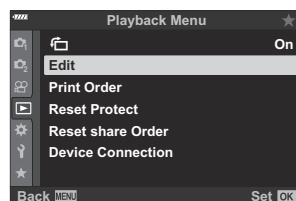

2. Highlight **[Sel. Image]** using $\Delta \nabla$ and press the **OK** button.



- The pictures on the memory card will be displayed.

3. Use $\triangleleft \triangleright$ to select the image to be edited and press the **OK** button.



- The edit menu will be displayed.

4. Highlight **[RAW Data Edit]** using $\Delta \nabla$ and press the **OK** button.

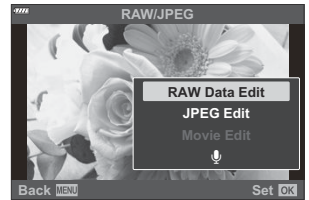

- Edit options will be displayed.

ⓘ If the current picture is not a RAW image, **[RAW Data Edit]** will not be available. Select a different image.

5. Highlight items using $\Delta \nabla$.

- To apply current camera settings, highlight **[Current]** and press the **OK** button. Current settings will be applied.
 - Highlight **[Yes]** using $\Delta \nabla$ and press the **OK** button to create a JPEG copy using the selected settings.
- For **[Custom1]** or **[Custom2]**, highlight the desired option and press \triangleright , then edit settings as follows:
 - Retouch options will be displayed. Highlight items using $\Delta \nabla$ and use $\triangleleft \triangleright$ to choose settings. Repeat until all the desired settings have been chosen. Press the \odot button to preview the results.



- Press the **OK** button to confirm the settings. The processing will be applied to the image.
- Highlight **[Yes]** using $\Delta \nabla$ and press the **OK** button to create a JPEG copy using the selected settings.
- Highlighting **[ART BKT]** and pressing \triangleright displays a list of art filters. Highlight art filters and press the **OK** button to select or deselect; selected filters are marked with a \checkmark . Press the **MENU** button to return to the previous display once all the desired filters have been selected.
 - Press the **OK** button to record the image after processing with the selected art filter.

6. To create additional copies from the same original, highlight **[Reset]** and press the **OK** button. To exit without creating more copies, highlight **[No]** and press the **OK** button.



- Selecting **[Reset]** displays editing options. Repeat the process from Step 5.



⌂ You can also edit selected pictures during playback.

▶ button \rightarrow Display a picture you want to retouch \rightarrow Press the **OK** button to view options \rightarrow **[RAW Data Edit]**

Retouching JPEG Pictures (JPEG Edit)



The **[JPEG Edit]** menu contains the options listed below.

Shadow Adj	Brighten back-lit subjects.
Red-eye Fix	Reduce "red-eye" in pictures taken with a flash.
	Crop pictures. Size the crop with the front or rear dial and position it with $\Delta \nabla \triangleleft \triangleright$.
Aspect	Change the aspect ratio from the standard 4:3 to [3:2] , [16:9] , [1:1] , or [3:4] . After choosing an aspect ratio, use $\Delta \nabla \triangleleft \triangleright$ to position the crop.
Black & White	Create a black-and-white copy of the current picture.
Sepia	Create a sepia copy of the current picture.
Saturation	Adjust the vividness of colors. The results can be previewed in the display.
	Create a resized copy 1280 × 960, 640 × 480, or 320 × 240 pixels in size. Pictures with an aspect ratio other than the standard 4:3 are resized to dimensions as close as possible to the selected option.
e-Portrait	Smooth complexions. The desired effect may not be achieved if no faces are detected.

- ⚠ Red-eye correction may not work depending on the image.
- ⚠ Editing of a JPEG image is not possible in the following cases:
 - When an image is processed on a PC, when there is not enough space in the card memory, or when an image is recorded on another camera.
- ⚠  cannot be used to make pictures larger.
- ⚠ Some images cannot be resized.
- ⚠  (crop) and **[Aspect]** only apply to pictures with an aspect ratio of 4:3 (standard).

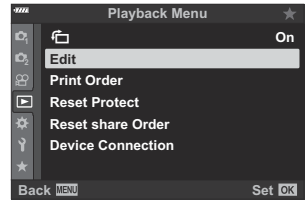

1. Highlight **[Edit]** in the  Playback Menu and press .



2. Highlight **[Sel. Image]** using   and press the **OK** button.





- The pictures on the memory card will be displayed.

3. Use   to select the image to be edited and press the **OK** button.



- The edit menu will be displayed.

4. Highlight **[JPEG Edit]** using   and press the **OK** button.

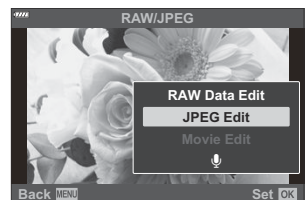

- Edit options will be displayed.
- If the current picture is not a JPEG image, **[JPEG Edit]** will not be available. Select a different image.

5. Highlight an option using $\Delta \nabla$ and press the **OK** button.

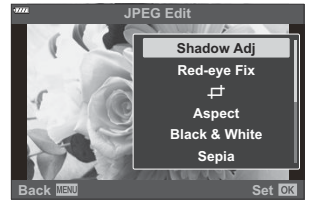

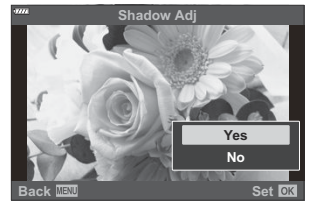

- The effect can be previewed in the display. If multiple options are listed for the selected item, use $\Delta \nabla$ to choose the desired option.
- When [**+**] is selected, you can size the crop using the dials and position it using $\Delta \nabla \triangleleft \triangleright$.
- When [**Aspect**] is selected, you can select an option using $\Delta \nabla$, and then position the crop using $\Delta \nabla \triangleleft \triangleright$.

6. Highlight [**Yes**] using $\Delta \nabla$ and press the **OK** button.



- The new copy will be saved at the selected settings and the camera will return to the playback display.

 You can also access retouch options when a JPEG picture is displayed during playback:

 button \rightarrow Display a picture you want to retouch \rightarrow Press the **OK** button to view options \rightarrow [**JPEG Edit**]

Combining Pictures (Image Overlay)

Overlay existing RAW photos to create a new picture. Up to 3 pictures can be included in the overlay. The results can be modified by adjusting brightness (gain) separately for each picture.

1. Highlight **[Edit]** in the  Playback Menu and press the **OK** button.
2. Highlight **[Image Overlay]** using the Δ ∇ buttons and press the **OK** button.
3. Select the number of images to be overlaid and press the **OK** button.
4. Highlight RAW images for the overlay using Δ ∇ \triangleleft \triangleright and press the **OK** button.

- Selected pictures are marked with a \checkmark . To deselect, press the **OK** button again.









- An overlay will be displayed once the number of images selected in Step 3 have been selected.

5. Adjust the gain for each of the images in the overlay.
 - Highlight images using the \triangleleft \triangleright buttons and adjust gain using the Δ ∇ buttons.
 - Gain can be adjusted in the range 0.1 – 2.0. Check the results in the monitor.



6. Press the **OK** button; a confirmation dialog will be displayed.
 - Highlight **[Yes]** and press the **OK** button.

 The overlay is saved in the format currently selected for image quality. Overlays created with **[RAW]** selected for image quality are saved in RAW format and in JPEG format using the image quality option selected for **[ 2]**.  **Custom Menu**  **[ 2] Set** (P. 288)

 Overlays saved in RAW format can in turn be combined with other RAW images to create overlays containing 4 or more pictures.

Creating Movie Stills (In-Movie Image Capture)

Save a still copy of a selected frame.

ⓘ This option is available only with **[4K]** movies recorded with the camera.

1. Highlight **[Edit]** in the  Playback Menu and press the **OK** button.
2. Highlight **[Sel. Image]** using the Δ ∇ buttons and press the **OK** button.
3. Select a movie using \triangleleft \triangleright and press the **OK** button.
4. Select **[Movie Edit]** and press the **OK** button.
5. Highlight **[In-Movie Image Capture]** using the Δ ∇ buttons and press the **OK** button.
6. Using the \triangleleft \triangleright buttons, select the frame you want to save as a still and press the **OK** button.
 - The camera will save a still copy of the selected frame.
 - Use the Δ button to rewind and the ∇ button to advance.

Trimming movies (Movie Trimming)

Cut selected footage from movies. Movies can be trimmed repeatedly to create files containing only footage you want to preserve.

 This option is available only with movies recorded with the camera.

1. Highlight **[Edit]** in the  Playback Menu and press the **OK** button.
2. Highlight **[Sel. Image]** using the Δ ∇ buttons and press the **OK** button.
3. Select a movie using \triangleleft \triangleright and press the **OK** button.
4. Select **[Movie Edit]** and press the **OK** button.
5. Highlight **[Movie Trimming]** using the Δ ∇ buttons and press the **OK** button.
 - You will be prompted to choose how you want to save the edited movie.
 - [New File]:** Save the trimmed movie in a new file.
 - [Overwrite]:** Overwrite the existing movie.
 - [No]:** Exit without trimming the movie.
 - **[Overwrite]** cannot be applied to protected movies.
6. Highlight the desired option and press the **OK** button.
 - You will be presented with an edit display.
7. Trim the movie.
 - Use the Δ button to skip to the first frame and the ∇ button to skip to the last frame.
 - Using the front or rear dial, select the first frame of the footage you want to delete and press the **OK** button.
 - Using the front or rear dial, highlight the last frame of the footage you want to delete and press the **OK** button.

8. Highlight **[Yes]** and press the **OK** button.

- The edited movie will be saved.
- To select different footage, highlight **[No]** and press the **OK** button.
- If you selected **[Overwrite]**, you will be prompted to choose whether to trim additional footage from the movie. To trim additional footage, highlight **[Continue]** and press the **OK** button.

Removing Protection from All Pictures (Reset Protect)

Remove protection from multiple pictures simultaneously.

1. Highlight **[Reset Protect]** in the  Playback Menu and press the **OK** button.
2. Highlight **[Yes]** and press the **OK** button.

Canceling a share order (Reset share Order)

Cancel share orders that are set on images.

1. Highlight **[Reset share Order]** in the  Playback Menu and press the **OK** button.
2. Highlight **[Yes]** and press the **OK** button.

Using the Setup Menu

The Setup Menu

Adjust basic camera settings. Examples include language selection and monitor brightness. The setup menu also contains options used during the initial setup process.



Option	Description
Card Setup	Format the card and delete all images (P. 264).
⌚ Settings (Date/time setting)	Set the camera clock (P. 34).
🗨️ (Changing the display language)	Choose a language for camera menus and guides (P. 36).
📺 (Monitor brightness adjustment)	<p>You can adjust the brightness and color temperature of the monitor. Color temperature adjustment is only applied to the monitor display during playback. Use <math>\triangleleft>\triangleleft>\triangleright</math> to highlight ⌂ (color temperature) or ☀ (brightness) and \triangleup \triangledown to adjust the value.</p> <p>Press the INFO button to switch the saturation of the monitor between [Natural] and [Vivid] settings.</p>
Image Review	<p>Choose whether pictures are automatically displayed after shooting and if so, for how long. This is useful for a brief check of the picture you have taken. You can shoot the next shot by pressing the shutter button halfway even while the captured image is displayed on the monitor.</p> <p>[0.3sec] – [20sec]: Sets the length of time (seconds) to display the captured image on the monitor.</p> <p>[Off]: The captured image is not displayed on the monitor.</p> <p>[Auto] ▶: Displays the captured image, and then switches to playback mode. This is useful for erasing a picture after checking it.</p>

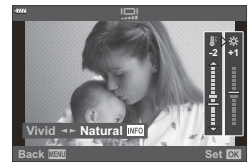

Option	Description
Wi-Fi/Bluetooth Settings	Adjust settings for connection to Wi-Fi/ Bluetooth [®] - compatible smartphones and optional remote controls using the camera's wireless function (P. 362 , P. 369 , P. 357).
Firmware Version	View the versions of the firmware for the camera and any lenses or other peripherals currently connected. You may need this information when contacting customer support or performing firmware updates.

Formatting the card (Card Setup)

Cards must be formatted with this camera before first use or after being used with other cameras or computers.

- ⓘ All data stored on the card, including protected images, is erased when the card is formatted. When formatting a used card, confirm there are no images that you still want to keep on the card.

👉 "Usable cards" (P. 28)

1. Highlight **[Card Setup]** in the **Y** Setup Menu and press the **OK** button.

- A menu will be displayed if the card contains data. Highlight **[Format]** and press the **OK** button.

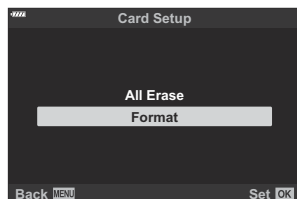

2. Highlight **[Yes]** and press the **OK** button.

- The card will be formatted.

Deleting all images (Card Setup)

All images on a card can be deleted at a time. Protected images are not deleted.

1. Highlight **[Card Setup]** in the **Y** Setup Menu and press the **OK** button.

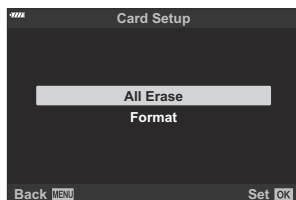

2. Highlight **[All Erase]** and press the **OK** button.

3. Highlight **[Yes]** and press the **OK** button.
 - All images are deleted.

Using “My Menu”

My Menu

You can use “My Menu” to create a personalized menu tab containing only items you select. “My Menu” can contain up to 5 pages of 7 items each. You can delete items or change the page or item order.

At purchase, “My Menu” contains no items.

Adding Items to My Menu

1. Press the **MENU** button to view the menus.
2. Highlight an item for inclusion in “My Menu”.
 - Items that can be added to “My Menu” are indicated by a ★ icon at the top right corner of the display.

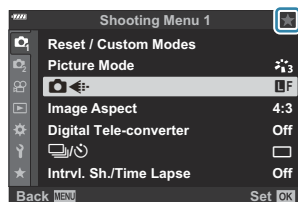

3. Press the **MOVIE** button.

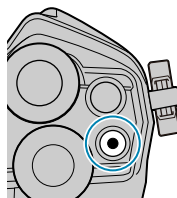

- You will be prompted to choose a page. Use Δ ∇ on the arrow pad to choose the “My Menu” page to which the item will be added.

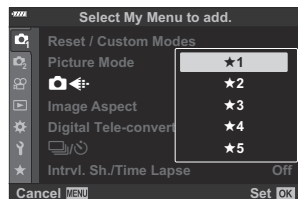

4. Press the **OK** button to add the item to the selected page.

- The camera will display a message stating that the item has been added to "My Menu".

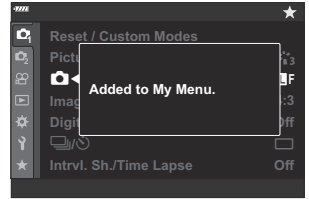

- Items that have been added to "My Menu" are indicated by a yellow ★.
- The next available page will be displayed once the seventh item is added to the current page.
- Items marked with a ★ can be removed from "My Menu" by pressing the **⊙** button. Select **[Yes]** and press the **OK** button.
- Items saved to "My Menu" are added to the ★ ("My Menu") tab.

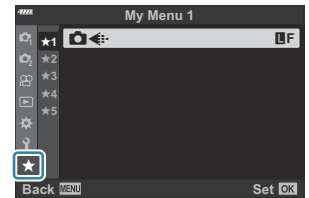
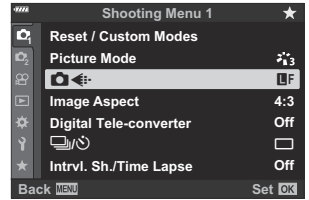

5. To access "My Menu", select the ★ ("My Menu") tab.

Managing “My Menu”

You can reorder or delete items in “My Menu”.

1. Press the **MENU** button to view the menus.
2. Display the “My Menu” page you want to edit and press the  (movie) button.

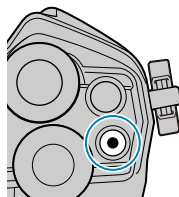

- The options below will be displayed.
 - [Rearrange Order]:** Change the order of items or pages. Use the Δ ∇ \triangleleft \triangleright buttons to choose the new location.
 - [Remove this item]:** Remove the highlighted item from “My Menu”. Select **[Yes]** and press the **OK** button.
 - [Remove this ★ tab]:** Remove from “My Menu” all items on the current page. Select **[Yes]** and press the **OK** button.

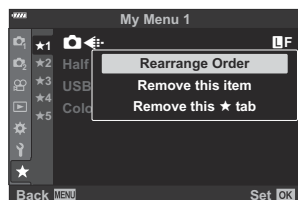





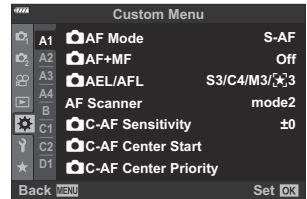

Using the Custom Menu

The Custom Menu

Camera settings can be customized using the  Custom Menu.









Custom Menu

- A1 / A2 / A3 / A4** AF/MF (P. 270)
- B** Button/Dial (P. 275)
- C1 / C2** Release//Image Stabilizer (P. 277)
- D1 / D2 / D3 / D4** Disp//PC (P. 279)
- E1 / E2 / E3** Exp/ISO/BULB/ (P. 284)
- F**  Custom (P. 287)
- G** /WB/Color (P. 288)
- H1 / H2** Record/Erase (P. 290)
- I** EVF (P. 293)
- J1 / J2**  Utility (P. 295)

A1 AF/MF



MENU → ⚙️ → A1











Option	Description
 AF mode	Choose the AF mode for still photography (P. 118).
 AF+ MF	Once the camera has focused using autofocus, focus can be adjusted manually using the lens focus ring (P. 298).
 AEL/AFL	Choose how the camera sets focus and exposure when the shutter button or AEL/AFL button is pressed (P. 299).
AF Scanner	<p>Choose the type of AF scan¹ performed in autofocus mode when the camera is unable to focus or the scene lacks contrast.</p> <p>1 Scans whole range from minimum range to infinity for focus point when the camera cannot focus on the subject or the contrast is not clear.</p> <p>ⓘ The selected option takes effect when [C-AF], [C-AF+TR], [C-AF MF], or [C-AF+TR MF] is chosen for [📷 AF Mode] (P. 118).</p> <p>[mode1]: AF Scanner is not activated.</p> <p>[mode2]: An AF scan is performed only once at the start of the focus operation.</p> <p>[mode3]: AF Scanner is activated.</p>
 C-AF Sensitivity	Choose how rapidly the camera responds to changes in the distance to the subject while focusing with [C-AF] , [C-AF MF] , [C-AF+TR] , or [C-AF+TR MF] selected for [📷 AF Mode] . This can help autofocus track a quickly-moving subject or prevent the camera refocusing when an object passes between the subject and the camera (P. 302).

Option	Description
 C-AF Center Start	When used in combination with an AF-target mode other than single target, [C-AF] , [C-AF MF] , [C-AF+TR] , and [C-AF+TR MF] focus on the center of the selected group only during the initial scan. During later scans, the camera will focus using the surrounding targets. Combining this option with an AF-target mode that covers a wide area makes it easier to focus on erratically-moving subjects (P. 303).
 C-AF Center Priority	When focusing using group- or -target AF in [C-AF] and [C-AF MF] modes, the camera always assigns priority to the center target in the selected group for a repeated series of focus operations. Only if the camera is unable to focus using the center focus target will it focus using the surrounding targets in the selected focus group. This helps you track subjects that are moving quickly but relatively predictably. C-AF center priority is recommended in most situations (P. 304).

A2 AF/MF

MENU →  → **A2**

Option	Description
  Mode Settings	Choose the target modes displayed during AF-target mode selection. Hiding unused modes speeds target-mode selection. To hide an item, highlight it and press the OK button to remove the check mark (P. 91).

Option	Description
AF Area Pointer	<p>In autofocus mode, the position of the subject on which the camera has focused is shown by a green focus target. This item controls the display of the focus target.</p> <p>[Off]: The focus target is not displayed.</p> <p>[On1]: The focus target is displayed only briefly after the camera focuses.</p> <p>[On2]: After the camera focuses, the focus target will be displayed while the shutter button is pressed halfway.</p> <p> To enable cluster AF targeting when  (all targets) is selected and [S-AF], [S-AF MF], [C-AF], or [C-AF MF] is chosen for [AF Mode] (P. 118) or [C-AF] is selected for [AF Mode], select [On2] for [AF Area Pointer]. The camera will display AF targets for all areas that are in focus.</p> 
 Set Home	Choose the home position AF mode, AF target selection mode, and AF target mode. Press the OK button to select the desired options in the  Set Home display (P. 305).
 Select Screen Settings	Choose the roles played by the front and rear dials or arrow pad during AF target selection (P. 307).
 Loop Settings	<p>Choose whether AF-target selection “wraps around” the edges of the display. You can also choose whether you have the option of selecting  (all targets) before AF-target selection “wraps around” to the opposite border of the display (P. 308).</p> <ul style="list-style-type: none"> • Wrap is disabled in movie mode and when [AF] or [AF MF] is selected for [AF Mode].
 Target Mode Settings	Choose the number of AF targets available and how far the AF target moves during AF-target selection (P. 309).
 Orientation Linked 	The camera can be configured to change the AF-target position and AF-target mode automatically when it detects that it has been rotated between landscape (“wide”) or portrait (“tall”) orientations (P. 310).

A3 AF/MF

MENU → ⚙️ → A3

Option	Description
AF Targeting Pad	If [On] is selected, the AF target can be positioned by tapping the monitor during viewfinder photography. Tap the monitor and slide your finger to position the AF target. 👉 When set to [On] , drag operation can be disabled or enabled by double-tapping the monitor. 👉 [AF Targeting Pad] can also be used with zoom frame AF (P. 96).
AF Limiter	Select [On] to limit the range in which the camera will focus using autofocus (P. 312).
AF Illuminator	Select [Off] to disable the AF illuminator. To use the AF illuminator during silent photography, you will need to change the option selected for [Silent ▼] Mode Settings (P. 232).
😊 Face Priority	Adjust settings for face- and eye-priority AF (P. 126).
AF Focus Adj.	Fine-tune phase-detection autofocus by up to ± 20 (P. 313). <ul style="list-style-type: none">• Normally there is no need to fine-tune autofocus using this item. Fine-tuning focus may prevent the camera focusing normally.

A4 AF/MF







MENU → ⚙️ → A4





Option	Description
Starry Sky AF Setting	Choose a setting for starry sky AF (P. 121). [Accuracy]: Prioritize focus accuracy over speed. Use a tripod. [Speed]: Prioritize focus speed over accuracy.

Option	Description
Preset MF distance	Choose the Preset MF focus position. Numerical value and unit (m, ft) can be set. The distance is approximate and not exact.
MF Assist	Choose whether rotating the focus ring in manual focus mode automatically activates focus zoom or focus peaking (P. 317).
MF Clutch	<p>Disable the manual focus clutch. This can prevent autofocus being disabled by the clutch engaging accidentally (P. 429).</p> <p>[Operative]: The camera responds to the position of the lens focus ring.</p> <p>[Inoperative]: The camera focuses according to the option selected for [AF Mode], regardless of the position of the lens focus ring. Manual focus is not available even when the focus ring is in the manual focus position.</p>
Focus Ring	Reverse the direction in which the focus ring is rotated for adjustments to focus.
Bulb/Time Focusing	You can change the focus position during exposure by using manual focus (MF). Selecting [Off] to disable adjustments to focus using the focus ring (P. 318).
Reset Lens	<p>When set to [Off], the focus position of the lens is not reset even when the power is turned off. When set to [On], the focus of power zoom lenses is also reset.</p> <ul style="list-style-type: none"> Regardless of the option selected, the focus position will be reset when the camera is turned off if [PreMF] is selected for [AF Mode] (P. 118).

Button/Dial

MENU → ⚙ → 





Option	Description
 Button Function	Other roles can be assigned to buttons in place of their existing functions (P. 167).
 Dial Function	Choose the roles played by front and rear dials (P. 319).
Dial Direction	Choose the direction in which the dial is rotated to adjust shutter speed or aperture. Change the program shift direction in which the dial is rotated.
 Fn Lever Function	Choose the function performed by the Fn lever (P. 321).
Fn Lever/Power Lever	<p>Use the Fn lever as a power switch.</p> <p>[Fn]: Follows settings for the Fn lever function.</p> <p>[Power 1]: The power turns on when the Fn lever is in position 1, and off when in position 2.</p> <p>[Power 2]: The power turns on when the Fn lever is in position 2, and off when in position 1.</p> <p>When [Power 1] or [Power 2] is set, the ON/OFF lever (power lever),  Fn Lever Function and  Fn Lever Function are disabled.</p>
 Elec. Zoom Speed	Choose the speed at which power zoom lenses zoom in or out when the zoom ring is rotated. Adjust zoom speed if it is so quick that you find it hard to frame your subject. Choose from [Low] , [Normal] , and [High] .

Option	Description
  Function	<p>Choose the role played by the  button during playback.</p> <p>: Create or modify a "share order" by marking pictures for upload to a smartphone.</p> <p>: Select multiple pictures.</p>

C1 C2 Release//Image Stabilizer

C1 Release//Image Stabilizer



MENU → ⚙ → C1

Option	Description
S-AF Release Priority	If [On] is selected, the shutter can be released even when the camera is not in focus. This option can be set separately for S-AF and C-AF modes (P. 118).
C-AF Release Priority	ⓘ Regardless of the option selected, [S-AF Release Priority] is used when [AF] is selected for AF mode.
 L Settings	Choose frame advance rates and shot limits for [] , [] , and [] modes. You can also adjust Pro Capture settings, including the frame advance rate, number of frames buffered, and the shot limit. Figures for sequential shooting speed are the approximate maximums (P. 322).
 H Settings	
Flicker Reduction	Reduce flicker in photos taken under fluorescent or other artificial lighting (P. 325). [Anti-Flicker LV]: Reduce flicker during live view under some kinds of lighting, including fluorescent lamps. If [Auto] does not have the desired effect, select [50 Hz] or [60 Hz] according to the frequency of the local power supply. [Anti-Flicker Shooting]: The camera automatically detects the flicker frequency and times the shutter release accordingly.

C2 Release//Image Stabilizer







MENU → ⚙ → C2





Option	Description
 Image Stabilizer	Adjust image stabilization settings for still photography (P. 134).

Option	Description
 Image Stabilizer	<p>Choose whether the camera prioritizes frame rate or image stabilization during burst photography.</p> <p>ⓘ [ Image Stabilizer] is fixed at [Fps Priority] in ^{Pro}CapL (Pro Capture Low) and ^{Pro}CapH (Pro Capture High) modes.</p> <p>[Fps Priority]: Shooting speed gets priority over image stabilization. The sensor will not be reset to the center during sequential shooting.</p> <p>[IS Priority]: Image stabilization gets priority over shooting speed. The sensor will be reset to the center per frame of sequential shooting. The shooting speed will drop slightly.</p>
Half Way RIs With IS	<p>When set to [Off], the IS (Image Stabilization) function while the shutter button is pressed halfway will not be activated.</p>
Lens I.S. Priority	<p>Select [On] to give priority to lens on-board image stabilization when shooting with third-party lenses. [S-IS I] will be used when [S-IS AUTO] is selected for [ Image Stabilizer] (P. 134).</p> <p>ⓘ This option has no effect on lenses that are equipped with an image stabilization switch.</p>

D1 Disp/⏏)/PC

MENU → ⚙ → D1

Option	Description
 Control Settings	Choose the shooting modes in which the live and LV super control panels are displayed (P. 329)
 /Info Settings	<p>Choose the information displayed when the INFO button is pressed (P. 332).</p> <p>[ Info]: Choose the information displayed in full frame playback.</p> <p>[  Info]: Choose the information displayed in magnified playback.</p> <p>[LV-Info]: Choose the information displayed when the camera is in shooting mode.</p> <p>[LV OFF-Info]: Choose a shooting display.</p> <p>[ Settings]: Choose the information displayed in index and calendar playback.</p>
Picture Mode Settings	Choose the picture modes (P. 154) available for selection. To hide an item, highlight it and press the OK button to remove the check mark.
 Settings	Choose the sequential shooting/self-timer modes (P. 101) available for selection. To hide an item, highlight it and press the OK button to remove the check mark.
Multi Function Settings	Choose the multi function options (P. 176) available for selection. To hide an item, highlight it and press the OK button to remove the check mark.

Option	Description
Live View Boost	<p>Adjust brightness for ease of viewing when lighting is poor. Settings can be adjusted separately for mode M, bulb photography, live composite photography, and the like.</p> <p>[Off]: Preview exposure in live view. Exposure can be previewed before shooting.  This option does not apply during bulb or time photography.</p> <p>[On1]: Exposure preview disabled; brightness is adjusted for ease of viewing. The brightness of the preview differs from the final photograph.</p> <p>[On2]: As for [On1] but brighter. Choose when framing shots of the night sky or the like.  The brightness of the preview differs from the final photograph. Subject motion may also appear slightly jerky.</p> <ul style="list-style-type: none"> • Press ▷ on the arrow pad and choose from the following: <ul style="list-style-type: none"> [Quality Priority]: Prioritize display quality. [Frame Rate Priority]: Prioritize display speed.
Art LV Mode	<p>[mode1]: The filter effect is always displayed.</p> <p>[mode2]: Priority is given to smooth display while the shutter button is pressed halfway. The quality of art filter effect previews may be affected.</p>
LV Close Up Settings	<p>[LV Close Up Mode]: When set to [mode1], pressing the button halfway in the magnified live view returns to the magnified frame display. When set to [mode2], pressing the button halfway in the magnified live view switches to the Zoom AF display.</p> <p>[Live View Boost]: If [On] is selected, the camera will adjust display brightness for ease of viewing during focus zoom. When set to [Off], the magnified area is displayed with the brightness of live view before magnification. This is useful to check the focus when shooting in backlit locations.  This item is available when [Off] is selected for [Live View Boost] in  Custom Menu D2.</p>

Option	Description
Default Setting	Choose the starting zoom ratio for playback zoom (close-up playback; P. 335).
Settings	<p> Lock: Select [On] to maintain the aperture at the selected value even when releasing the button.</p> <p>[Live View Boost]: If [On] is selected, the camera will adjust display brightness for ease of viewing during depth-of-field preview (P. 169).</p> <p> This item is available when [Off] is selected for [Live View Boost] in Custom Menu D2.</p>

Disp/

MENU → →

Option	Description
Grid Settings	<p>Adjust settings for the framing grid.</p> <p>[Display Color]: Adjust guide color and transparency. The camera can store up to two combinations of settings.</p> <p>[Displayed Grid]: Select the type of guides displayed. Choose from:</p> <ul style="list-style-type: none"> • , , , , , and <p> When is selected, the guides are adjusted for a 16:9 movie frame when movies are shot in still photography mode. Depending on the option selected for , the guides may be displayed with an aspect ratio of 17:9.</p> <p>[Apply Settings to EVF]: Choose whether the option selected for [Displayed Grid] is reflected in the viewfinder display.</p> <p> The option selected for [EVF Grid Settings] in Custom Menu I (P. 293) has no effect.</p>

Option	Description
Peaking Settings	<p>Highlight objects using color outlines. This makes objects that are in focus easier to see during manual focus and the like.</p> <p>[Peaking Color]: Choose the focus peaking color.</p> <p>[Highlight Intensity]: Choose the focus peaking level.</p> <p>[Image Brightness Adj.]: Adjust background brightness to make focus peaking easier to see.</p> <p>🔊 When [On] is selected for [Image Brightness Adj.], the live view display may be brighter or darker than the final photograph.</p>
Histogram Settings	<p>Choose the upper and lower bounds for the shadow and highlight displays (P. 332)</p> <p>[Highlight]: Choose the lower bound for the highlight display.</p> <p>[Shadow]: Choose the upper bound for the shadow display.</p>
Mode Guide	<p>Select [On] to display a help for the selected mode when the mode dial is rotated to a new setting (P. 43).</p>
Selfie Assist	<p>If [On] is selected, the camera will display a mirror image of the view through the lens when the monitor is in the selfie position (P. 336).</p>

D4 Disp/■))) / PC









MENU → ⚙ → **D4**





Option	Description
■)))	<p>[On]: A beep sounds after successful autofocus operations.</p> <p>[Off]: A beep does not sound after successful autofocus operations.</p>

Option	Description
HDMI	<p>Adjust settings for connection to HDMI devices (P. 337).</p> <p>[Output Size]: Selecting the digital video signal format for connecting to a TV via an HDMI cable.</p> <p>[HDMI Control]: Select [On] to allow the camera to be operated using remotes for TVs that support HDMI control. This option takes effect when pictures are displayed on a TV. When [On] is selected, the camera can be used for playback only.</p> <p>[Output Frame Rate]: Select the output frame rate from [50p Priority] or [60p Priority] for using the camera connected to a TV with an HDMI cable.</p>
USB Mode	<p>Choose how the camera functions when connected to external devices via USB (P. 339).</p>

E1 Exp/ISO/BULB/ 

MENU → ⚙ → E1

Option	Description
EV Step	Choose the size of the increments used when adjusting shutter speed, aperture, exposure compensation, and other exposure-related settings.
ISO Step	Choose the size of the increments used when adjusting ISO sensitivity.
 ISO-Auto Set	<p>Adjust [AUTO] ISO sensitivity settings for still photography.</p> <p>[Upper Limit / Default]: Choose the maximum and default ISO sensitivity used when [AUTO] is selected for ISO. Select [Upper Limit] to choose the maximum sensitivity, [Default] to choose the default sensitivity. The maximum is 6400.</p> <p> The maximum ISO sensitivity automatically changes:</p> <ul style="list-style-type: none"> - to ISO 800 when the live ND filter is enabled, - to ISO 1600 when [Shooting Method] > [Tripod] is selected for High Res Shot, and - to ISO 1600 when [Dramatic Tone] or [Watercolor] is selected for picture mode. <p>[Lowest S/S Setting]: Choose the shutter speed at which the camera starts raising ISO sensitivity automatically in modes P and A. Choose [Auto] to let the camera choose a shutter speed automatically.</p>
 ISO-Auto	<p>Choose the shooting modes in which [AUTO] ISO sensitivity takes effect.</p> <p>[P/A/S]:  [ISO] > [AUTO] takes effect only in modes P, A, and S. If [AUTO] is in effect when mode M or B is selected,  [ISO] will be set to ISO 200.</p> <p>[P/A/S/M]:  [ISO] > [AUTO] takes effect in modes P, A, S, and M. If you select mode B after choosing [AUTO],  [ISO] will be set to ISO 200.</p> <p>  [ISO] > [AUTO] takes effect in modes AUTO, SCN, and ART.</p>

Option	Description
 Noise Filter	Choose the amount of noise reduction performed at high ISO sensitivities.
 Low ISO Processing	<p>Choose the type of processing applied to photographs taken at low ISO sensitivities.</p> <p>[Drive Priority]: Image processing is adapted so as not to curtail the number of pictures that can be taken in a single burst.</p> <p>[Detail Priority]: Image processing prioritizes image quality.</p> <p> Regardless of the option selected, photographs taken in single-frame mode will be processed using [Detail Priority].</p>
Noise Reduct.	<p>This function reduces the noise that is generated during long exposures.</p> <ul style="list-style-type: none"> The time required for noise reduction is shown in the display. <p> [Off] is selected automatically during sequential shooting.</p> <p> This function may not work effectively with some shooting conditions or subjects.</p> <p>[Auto]: Noise reduction is performed at slow shutter speeds, or when the internal temperature of the camera has risen.</p> <p>[On]: Noise reduction is performed with every shot.</p> <p>[Off]: Noise reduction off.</p>

Exp/ISO/BULB/





MENU →  → 

Option	Description
Bulb/Time Timer	Choose the maximum exposure time for bulb and time photography (P. 58).
Live Composite Timer	Choose the maximum exposure time for live composite photography (P. 62).
Bulb/Time Monitor	Choose the brightness of the monitor when shooting in B (bulb) mode.

Option	Description
Live Bulb	Choose the display interval during shooting. The number of update times is limited. Choose [Off] to disable the display (P. 340, P. 341).
Live Time	
Composite Settings	Choose the reference exposure time for composite photography (P. 342).
 Flicker Scan	Reduce flicker under LED lighting (P. 343).

Exp/ISO/BULB/

MENU → →

Option	Description
Metering	Choose a metering mode according to the scene (P. 124).
AEL Metering	Choose the metering method used to meter exposure when exposure is locked using the AEL/AFL button. This allows you to use one metering method when exposure is locked by pressing the shutter button halfway and another when exposure is locked by pressing the AEL/AFL button. [Auto]: Exposure is metered using the method selected for [Metering] (P. 124).
 Spot Metering	Choose whether the [Spot] , [Spot Hilight] , and [Spot Shadow] spot metering options meter the selected AF target.  [☺ Face Priority] is automatically set to [Face Priority Off] .  The selected option takes effect when [·] (single target) or [·]S (small target) is selected as the AF-target mode (P. 91).  The camera zooms in on the selected AF target during focus zoom (P. 96).
Exposure Shift	Adjust correct exposure separately for each metering mode (P. 345).



F ⚡ CustomMENU → ⚙ → **F**

Option	Description
⚡ X-Sync.	Choose the fastest shutter speed available when a flash is used (P. 346).
⚡ Slow Limit	Choose the slowest shutter speed available when a flash is used (P. 346).
	Select [On] to add exposure compensation to the value selected for flash output (P. 89, P. 153).
⚡ +WB	Adjust white balance for use with a flash. [Off] : The camera uses the value currently selected for white balance. [^{WB}AUTO] : The camera uses auto white balance ([Auto]). [WB⚡] : The camera uses flash white balance ([WB⚡]).
⚡ RC Mode	Wireless remote-control flash units can be used with the flash unit for wireless remote-control flash photography (P. 434).

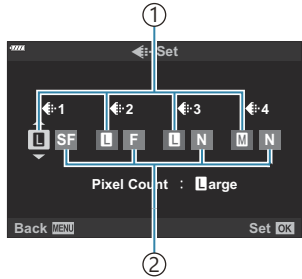

MENU → ⚙ → G

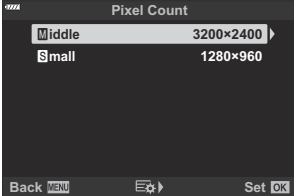
Option	Description
 Set	<p>Choose the combinations of image sizes and compression rates available when shooting JPEG photos. You have a choice of three image sizes and three compression rates (P. 139, P. 207, P. 347).</p> <div data-bbox="285 566 1024 1053" style="border: 1px solid gray; padding: 10px;"> <p>1. Highlight size or compression for the desired combinations ([◀-1] to [◀-4]) using the ◀▶ buttons and choose settings using the Δ ▽ buttons.</p>  <p>① Image size ② Compression rate</p> <p>2. Press the OK button.</p> </div>

Option	Description
Pixel Count	<p>Choose the pixel count for [M]- and [S]-size images (P. 139, P. 207, P. 347).</p> <div style="border: 1px solid gray; padding: 10px; margin: 10px 0;"> <p>1. Highlight [M]iddle or [S]mall and press the ▶ button.</p>  <p>2. Choose a pixel count and press the OK button.</p> </div>
Shading Comp.	<p>Choose [On] to correct peripheral illumination according to the type of lens.</p> <ul style="list-style-type: none"> ⚠ Compensation is not available for teleconverters or extension tubes. ⚠ Noise may be visible at the edges of photographs taken at high ISO sensitivities.
📷 WB	<p>Choose a white balance mode for still photography. Each mode can be fine-tuned (P. 129).</p>
📷 All WB 	<p>Fine-tune white balance across the board (P. 133).</p> <p>[All Set]: Fine-tune white balance for all modes.</p> <p>[All Reset]: Reset fine-tuning for all modes to default values.</p>
📷 WB  AUTO Keep Warm Color	<p>Select [On] to preserve “warm” colors in pictures taken with [AUTO] white balance under incandescent lighting (P. 129, P. 133).</p>
Color Space	<p>Choose a color space to ensure correct color reproduction when photos are printed or viewed on a monitor (P. 165).</p>

H1 Record/Erase

MENU → ⚙ → H1

Option	Description
File Name	<p>Choose how the camera assigns file numbers.</p> <p>[Auto]: Even when a new card is inserted, the file numbers are retained from the previous card. File numbering continues from the last number used or from the highest number available on the card.</p> <p>[Reset]: When you insert a new card, the folder numbers starts at 100 and the file name starts at 0001. If a card containing images is inserted, the file numbers start at the number following the highest file number on the card.</p>
Edit Filename	<p>Choose how files are named when photos and movies are saved to the memory card. You can change the following portions of the file name.</p> <p>sRGB: Pmdd0000.jpg --- Pmdd</p> <p>AdobeRGB: _mdd0000.jpg --- mdd</p> <ul style="list-style-type: none">• Select [Off] to use the default prefixes.
dpi Settings	<p>Choose the print resolution.</p>

Option	Description
Copyright Settings	<p>Add the names of the photographer and copyright holder to new photographs. Names can be up to 63 characters long.</p> <p>[Copyright Info.]: Select [On] to include the names of the photographer and copyright holder in the Exif data for new photographs.</p> <p>[Artist Name]: Enter the name of the photographer.</p> <p>[Copyright Name]: Enter the name of the copyright holder.</p> <div data-bbox="284 454 1029 912" style="border: 1px solid gray; padding: 10px;"> <ol style="list-style-type: none"> 1. Select characters from a and press the OK button. The selected characters appear in b. 2. Repeat Step 1 to complete the name, then highlight [END] and press the OK button. <ul style="list-style-type: none"> • To delete a character, press the INFO button to place the cursor in the name area b, highlight the character, and press ⏏.  </div> <p>ⓘ We do not accept liability for damages arising from disputes involving the use of [Copyright Settings]. Use at your own risk.</p>
Lens Info Settings	<p>Save lens info for up to 10 lenses that do not automatically supply info to the camera (P. 348).</p>

H2 Record/Erase



MENU → ⚙ → H2

Option	Description
Quick Erase	If [On] is selected, pressing the  button in the playback display will immediately delete the current image.
RAW+JPEG Erase	Choose the operation performed when pictures recorded at settings of RAW+JPEG are deleted using [Erase] (P. 189). ⓘ Both the RAW and JPEG copies are deleted when selected images are deleted or when [All Erase] (P. 265) is selected. [JPEG]: Only the JPEG copy is erased. [RAW]: Only the RAW copy is erased. [RAW+JPEG]: Both copies are erased.
Priority Set	Choose the default selection ([Yes] or [No]) for confirmation dialogs.

EVF

MENU → ⚙️ → ⓘ





Option	Description
EVF Auto Switch	<p>[Off]: The viewfinder display does not light automatically when you put your eye to the viewfinder. Press the ⓘ button to switch between the viewfinder and monitor displays (P. 40).</p> <p>[On1]: The viewfinder display lights automatically when you put your eye to the viewfinder. Pressing the ⓘ button displays [EVF Auto Switch] options.</p> <p>[On2]: The viewfinder display lights automatically when you put your eye to the viewfinder. The display does not change when the monitor is open. Pressing the ⓘ button displays [EVF Auto Switch] options.</p>
EVF Adjust	<p>Adjust viewfinder brightness and hue. Brightness is automatically adjusted when [EVF Auto Luminance] is set to [On]. The contrast of the information display is also adjusted automatically.</p>
EVF Style	<p>Choose a viewfinder display style (P. 349).</p>
Info Settings	<p>Choose the information that can be viewed by pressing the INFO button in the viewfinder display. This option takes effect when [Style 1] or [Style 2] is selected for [EVF Style] (P. 351).</p>
EVF Grid Settings	<p>Choose the type and color of framing grid displayed in the viewfinder when [Off] is selected for [Grid Settings] > [Apply Settings to EVF] in ⚙️ Custom Menu D3 and [Style 1] or [Style 2] is selected for [EVF Style]. Choose the framing grid from [⊞], [⊞], [⊞], [⊞], [⊞] or [⊞].</p> <p>ⓘ When [⊞] is selected, the guides are adjusted for a 16:9 movie frame when movies are shot in still photography mode. Depending on the option selected for [⊞ ←], the guides may be displayed with an aspect ratio of 17:9.</p>

Option	Description
 Half Way Level	<p>Choose whether the level gauge can be displayed in the viewfinder by pressing the shutter button halfway when [Style 1] or [Style 2] is selected for [EVF Style] (P. 349).</p> <p>[On]: The level gauge is displayed in the viewfinder while the shutter button is pressed halfway. The level gauge appears in place of the exposure bar.</p> <p>[Off]: The level gauge is not displayed.</p>
S-OVF	<p>Select [On] to increase the dynamic range of the viewfinder display, increasing the amount of detail visible in highlights and shadows in a manner similar to optical viewfinders. Backlit subjects and the like are easier to see.</p> <ul style="list-style-type: none"> •  is displayed in the viewfinder when [S-OVF] starts. <p> The display is not adjusted for settings such as white balance, exposure compensation, and picture mode.</p>

J1  Utility

MENU → ⚙️ → **J1**

Option	Description
Pixel Mapping	Perform simultaneous checks on the camera's image sensor and image processing functions (P. 444)
Press-and-hold Time	Choose the length of time buttons must be pressed to activate the "button hold" option (P. 352).
Level Adjust	<p>You can calibrate the angle of the level gauge.</p> <p>[Reset]: Reset the gauge to factory default settings.</p> <p>[Adjust]: Choose the current camera angle as the 0 position.</p>
Touchscreen Settings	Activate the touch screen. Choose [Off] to disable the touch screen.
Menu Recall	Set [Recall] to display the cursor at the last position of operation when you display a menu. The cursor position will be retained even when you turn off the camera.
Fisheye Compensation	Correct fisheye distortion when shooting with fisheye lenses (P. 353).

Option	Description
Backlit LCD	<p>Choose the length of time before the monitor backlight dims when no operations are performed. Dimming the backlight reduces the drain on the battery.</p> <ul style="list-style-type: none"> Choose from [Hold], [8sec], [30sec], and [1min]. The backlight will not dim if [Hold] is selected.
Sleep	<p>Choose the delay before the camera enters sleep mode when no operations are performed. In sleep mode, camera operations are suspended and the monitor turns off.</p> <ul style="list-style-type: none"> Choose from [Off], [1min], [3min], and [5min].  The camera will not enter sleep mode if [Off] is selected. Normal operation can be restored by pressing a button or pressing the shutter button halfway.  The camera will not enter sleep mode: <ul style="list-style-type: none"> while a multiple exposure is in progress or while connected to an HDMI device or wireless remote control, via Wi-Fi to a smartphone, or via Wi-Fi or USB to a computer
Auto Power Off	<p>The camera will turn off automatically if no operations are performed for a set time after it has entered sleep mode. This option is used to choose the delay before the camera turns off automatically (P. 33).</p> <ul style="list-style-type: none"> Choose from [Off], [5min], [30min], [1h], and [4h].  The camera will not turn off automatically if [Off] is selected.  To reactivate the camera after it has turned off automatically, turn the camera on using the ON/OFF lever.
Quick Sleep Mode	<p>If [On] is selected, the camera will enter power-saving mode more quickly when the live view display in the monitor is off. [Backlit LCD] and [Sleep] can be set to shorter intervals than normal. ECO displayed in the monitor while power-saving is in effect.</p> <ul style="list-style-type: none">  Power saving is not available: <ul style="list-style-type: none"> during live view photography, while the viewfinder is on, while multiple-exposure or interval-timer photography is in progress, while connected to an HDMI device, via Wi-Fi to a smartphone, or via Wi-Fi or USB to a computer, or while Bluetooth is enabled

Option	Description
Certification	Display certification icons.



Combined Auto and Manual Focus



(AF+MF)

MENU →  → **A1** → [ AF+MF]

After focusing using autofocus, you can adjust focus manually by keeping the shutter button pressed halfway and rotating the focus ring. Switch from auto to manual focus at will or fine-tune focus manually after focusing with autofocus.

- The procedure varies with the AF mode selected.
- **[Off]** is selected by default.

On	<p>Enable manual focus adjustment in autofocus mode. MF displayed next to [S-AF], [C-AF], [C-AF+TR], or [ AF].</p> <ul style="list-style-type: none">• When [S-AF MF] is selected, you can keep the shutter button pressed halfway after focusing using single AF and adjust focus manually. Alternatively, you can switch to manual focus by rotating the focus ring while the camera is focusing. Focus can also be adjusted manually while the shutter is open and during burst photography in [Sequential Low] mode.• When [C-AF MF] or [C-AF+TR MF] is selected, you can switch to manual focus by rotating the focus ring while the camera is focusing in continuous AF and continuous tracking AF modes. Press the shutter button halfway a second time to refocus using autofocus. Focus can also be adjusted manually while the shutter is open and during burst photography in [Sequential Low] mode.• When [ AF MF] is selected, you can focus manually after focusing or before initiating focus using [ AF].
Off	Manual focus adjustment disabled during autofocus.

- Autofocus with manual focus is also available when autofocus is assigned to other camera controls.
  **Custom Menu** **A1** > [ **AEL/AFL**] (P. 299)

🌀 The lens focus ring can be used to interrupt autofocus only when M.ZUIKO PRO (Micro Four Thirds PRO) lenses are used. For information on other lenses, visit our website.

🌀 In **B** (bulb) mode, manual focus is controlled by the option selected for **[Bulb/Time Focusing]**.

Setting Focus and Exposure with the AEL/AFL Button (📷 AEL/AFL)

MENU → ⚙️ → A1 → [📷 AEL/AFL]

Choose how the camera sets focus and exposure when the shutter button or **AEL/AFL** button is pressed. The camera normally focuses and locks exposure when the shutter button is pressed halfway, but this can be changed according to the subject or shooting conditions.

S-AF	
C-AF	Choose the focus or metering operation performed using the shutter or AEL/AFL button.
MF	
📷 AF	
Half Way AF	
Face Priority AF	Choose whether the camera focuses when the shutter is pressed halfway. <ul style="list-style-type: none">• [Operative]: Pressing the shutter button halfway initiates autofocus regardless of whether autofocus is currently assigned to the AEL/AFL button. In [C-AF] mode, the last button pressed is used to maintain focus. This option has no effect in [MF] or [📷 AF] mode.• [Inoperative]: Pressing the shutter button halfway will not initiate autofocus if autofocus is currently assigned to the AEL/AFL button.
	Choose whether the AEL/AFL and shutter buttons perform the same or different functions when faces are detected. <ul style="list-style-type: none">• If [On] is selected, the camera will focus on faces or eyes when the AEL/AFL button is pressed.• If [Off] is selected, the camera will instead focus on the current AF target.

The tables below show how the operations performed by the shutter and **AEL/AFL** buttons vary with the option selected for **[Half Way AF]**.

Shutter button pressed

AEL/AFL mode		Halfway		All the way down	
		AF	AE	AF	AE
S-AF	mode1	S-AF	Locks	—	—
	mode2	S-AF	—	—	Locks
	mode3	S-AF ¹	Locks	—	—
C-AF	mode1	C-AF	Locks	Ends	—
	mode2	C-AF	—	Ends	Locks
	mode3	C-AF ¹	Locks	Ends	—
	mode4	C-AF ¹	—	Ends	Locks
MF	mode1	—	Locks	—	—
	mode2	—	—	—	Locks
	mode3	—	Locks	—	—
☒ AF	mode1	☒ AF	Locks	—	—
	mode2	—	Locks	—	—
	mode3	—	Locks	—	—

1 Selecting **[Inoperative]** for **[Half Way AF]** disables autofocus.

ⓘ The behavior of **[☒ AF]** is affected by the option selected for **[Starry Sky AF Setting]** (P. 273).

AEL/AFL button

AEL/AFL mode		Kept pressed	
		AF	AE
S-AF	mode1	—	Locks
	mode2	—	Locks
	mode3	S-AF	—
C-AF	mode1	—	Locks
	mode2	—	Locks
	mode3	C-AF	—
	mode4	C-AF	—
MF	mode1	—	Locks
	mode2	—	Locks
	mode3	S-AF	—
☒ AF	mode1	—	Locks
	mode2	☒ AF	—
	mode3	☒ AF start/end	—

ⓘ The behavior of [☒ AF] is affected by the option selected for [\[Starry Sky AF Setting\]](#) (P. 273).

C-AF Tracking Sensitivity (📷 C-AF Sensitivity)

MENU → ⚙️ → A1 → [📷 C-AF Sensitivity]

Choose how rapidly the camera responds to changes in the distance to the subject while focusing with [C-AF], [C-AF MF], [C-AF+TR], or [C-AF+TR MF] selected for [📷 AF Mode]. This can help autofocus track a quickly-moving subject or prevent the camera refocusing when an object passes between the subject and the camera.

- Choose from five levels of tracking sensitivity.
- The higher the value, the higher the sensitivity. Choose positive values for subjects that suddenly enter the frame, that are moving rapidly away from the camera, or that change speed or stop suddenly while moving toward or away from the camera.
- The lower the value, the lower the sensitivity. Choose negative values to prevent the camera refocusing when the subject is briefly obscured by other objects or to prevent the camera focusing on the background when you are unable to keep the subject in the AF target.

1. Highlight [📷 C-AF Sensitivity] in ⚙️ Custom Menu A1 and press the **OK** button.

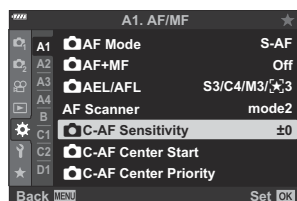

2. Highlight a value using the Δ ∇ buttons.

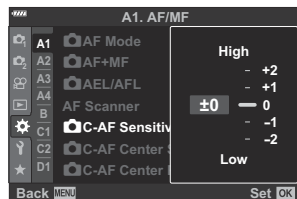

3. Press the **OK** button.
 - ⚙️ Custom Menu A1 will be displayed.
4. Press the **MENU** button repeatedly to exit the menu.

C-AF Starting Focus Target (📷 C-AF Center Start)

MENU → ⚙️ → A1 → [📷 C-AF Center Start]

When used in combination with an AF-target mode other than single target, **[C-AF]**, **[C-AF MF]**, **[C-AF+TR]**, and **[C-AF+TR MF]** focus on the center of the selected group only during the initial scan. During later scans, the camera will focus using the surrounding targets. Combining this option with an AF-target mode that covers a wide area makes it easier to focus on erratically-moving subjects.

1. Highlight **[📷 C-AF Center Start]** in ⚙️ Custom Menu **A1** and press the **OK** button.

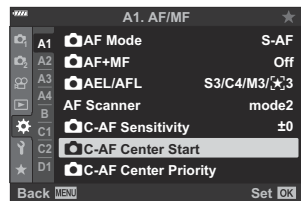

2. Using the Δ ∇ buttons, highlight the AF target modes to which **[📷 C-AF Center Start]** will apply and then press the **OK** button.

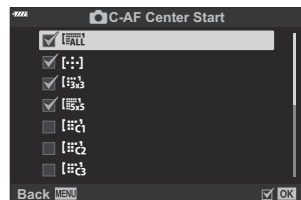

- Selected modes are marked with a check (✓). To deselect, press the **OK** button again.

3. Press the **MENU** button repeatedly to exit the menus.

① The options selected for **[📷 C-AF Center Priority]** (P. 304) (if any) take precedence those selected for **[📷 C-AF Center Priority]**.

C-AF Center Target Priority (📷 C-AF Center Priority)

MENU → ⚙️ → A1 → [📷 C-AF Center Priority]

When focusing using group- or -target AF in [C-AF] and [C-AF MF] modes, the camera always assigns priority to the center target in the selected group for a repeated series of focus operations. Only if the camera is unable to focus using the center focus target will it focus using the surrounding targets in the selected focus group. This helps you track subjects that are moving quickly but relatively predictably. C-AF center priority is recommended in most situations.

1. Highlight [📷 C-AF Center Priority] in ⚙️ Custom Menu A1 and press the **OK** button.

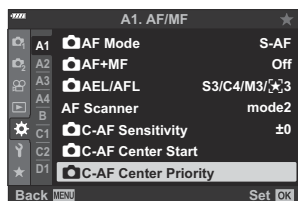

2. Using the Δ ∇ buttons, highlight the AF target modes to which [📷 C-AF Center Priority] will apply and then press the **OK** button.

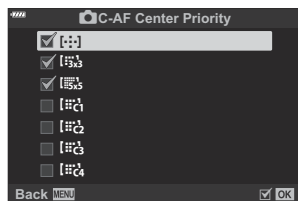

- Selected modes are marked with a check (✓). To deselect, press the **OK** button again.

3. Press the **MENU** button repeatedly to exit the menu.

Choosing the AF Home Position ([:::] Set Home)

MENU → **⚙️** → **A2** → **[:::] Set Home**

Choose the home position for the **[:::] Home** feature. The **[:::] Home** feature lets you recall a previously-saved “home position” for autofocus at the touch of a button. This item is used to choose the home position. To access **[:::] Home**, assign it to a control using **[📷 Button Function] (P. 167)**. If **[📷 Orientation Linked [:::]] (P. 310)** is active, the camera will store separate home positions for landscape (“wide”) and portrait (“tall”) orientations. **[HP]** appears in the AF-target selection display when the current home position is selected.

AF mode	Choose the home position autofocus mode. [📷 AF] and [📷 AF MF] cannot be assigned home positions.
AF Target Mode	Choose the home position AF target mode. Only options selected for [📷 [:::] Mode Settings] (P. 271) are available.
AF Target Point	Choose the home position focus target.

1. Highlight **[:::] Set Home** in **⚙️ Custom Menu A2** and press the **OK** button.

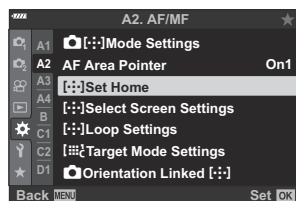

2. Highlight a setting you wish to store with the home position and press the **OK** button.

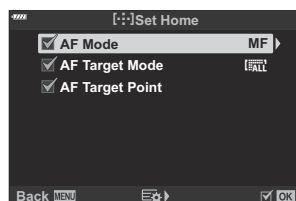

- Selected items are marked with a check (✓). Items marked with a ✓ are included in the home position.

3. Press the **▶** button to display options for the highlighted setting.

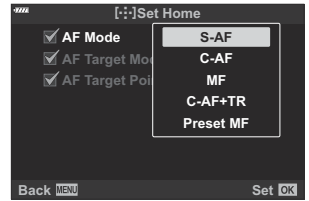

- Choose settings for the home position.
 - When **[📷 Orientation Linked [::]]** is active, you will be prompted to select landscape or portrait (camera rotated left/camera rotated right) orientation before pressing the **▶** button to display options.
4. Press the **OK** button to save changes when settings are complete.
 - The camera will return to the "[::] Set Home" display.
 5. Press the **MENU** button repeatedly to exit when settings are complete.

AF-Target Selection ([] Select Screen Settings)

MENU → → → [] Select Screen Settings]

Choose the roles played by the front and rear dials or arrow pad during AF target selection. The controls used can be selected according to how the camera is used or personal taste. You can choose up to two combinations.

- If you select **[Set 2]**, the options in the [] **Select Screen Settings** menu will be checked (✓).
[Set 2] can be recalled by pressing the **INFO** button in the AF-target selection display.

Available Controls

Front dial, rear dial,   buttons,   buttons

Available Roles

[ **Pos**]: Position the AF target (P. 95).

[] **Mode**]: Choose the AF target mode (e.g., all, small, or group) (P. 91).

[]: Adjust settings for face/eye detection AF (P. 126).

Enabling AF-Target Selection Wrap ([**⋮**]) Loop Settings)

MENU → **⚙** → **A2** → [**⋮**] Loop Settings]

You can choose whether AF-target selection “wraps around” the edges of the display. You can also choose whether you have the option of selecting **ALL** (all targets) before AF-target selection “wraps around” to the opposite border of the display.

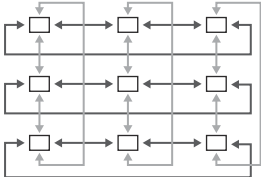
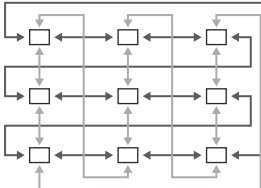
<p>[⋮] Loop Selection</p>	<p>[Off]: Wrap disabled. Target selection stays within the borders of the display.</p> <p>[Loop 1]: If you continue to press the △ ▽ ◀ ▶ buttons in the same direction after reaching the border of the display, the target in the same row or column on the opposite border will be selected.</p>  <p>“Loop 1”</p> <p>[Loop 2]: If you continue to press the △ ▽ ◀ ▶ buttons in the same direction after reaching the border of the display, the target in the next row or column on the opposite border will be selected.</p>  <p>“Loop 2”</p>
<p>Via ALL</p>	<p>[No]: Target selection does not pass through ALL (all targets) before wrapping around.</p> <p>[Yes]: If [Loop 1] or [Loop 2] is chosen for [⋮] Loop Selection, target selection will pass through ALL (all targets) before wrapping around to the opposite border.</p> <p>🔇 Hiding ALL (all targets) in [📷] Mode Settings fixes [Via ALL] at [No].</p>

🔇 [**⋮**] Loop Selection is fixed at **[Off]** during movie recording and when [**📷**] AF or [**📷**] AF MF is selected for focus mode.

AF Target Size and Positioning (Target Mode Settings)

MENU → ⚙ → A2 → Target Mode Settings

Choose the number of AF targets available and how far the AF target moves during AF-target selection. Targets can be larger than group targets or sized for subjects whose motion can be predicted. You can also increase the distance between available targets for faster target selection. The camera can store up to four different combinations of settings.

ⓘ If the AF-target or step size is altered from the default value, checks (✓) will appear next to the custom target options in [Target Mode Settings](#) (P. 271).

Size	Choose the target size. Target width and height can be set separately. Choose from options of 1, 3, 5, 7, 9, and 11.
Step	Choose the number of steps the target moves during target selection. The horizontal and vertical step sizes can be set separately; choose from steps of 1, 2, and 3.

Matching AF-Target Selection to Camera Orientation (📷 Orientation Linked [⋮])

MENU → ⚙️ → A2 → [📷 Orientation Linked [⋮]]

The camera can be configured to change the AF-target position and AF-target mode automatically when it detects that it has been rotated between landscape (wide) or portrait (tall) orientations. Rotating the camera changes the composition and consequently also the position of the subject in the frame. The camera can store the AF target mode and AF target position separately according to camera orientation. When this option is active, [⋮] **Set Home** (P. 305) can be used to store separate home positions for landscape and portrait orientations.

AF Target Mode	Choose separate AF target modes (e.g., all, small, or group) for landscape and portrait orientations.
AF Target Point	Choose separate AF targets for landscape and portrait orientations.

1. Highlight [📷 Orientation Linked [⋮]] in ⚙️ Custom Menu A2 and press ▶ on the arrow pad.

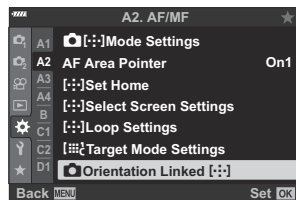

2. Highlight a setting you wish saved separately and press the OK button.

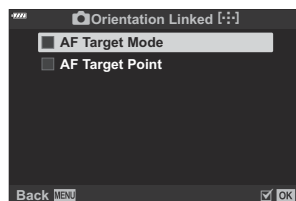

- Selected items are marked with a check (✓).

3. Press the MENU button repeatedly to exit when settings are complete.
 - Press the MENU button repeatedly to exit the menu.

- 4.** Choose the AF target mode or target position with the camera first in one orientation and then the other.
- Separate settings are stored for landscape orientation, portrait orientation with the camera rotated to the right, and portrait orientation with the camera rotated to the left.



Lens Focus Range (AF Limiter)

MENU →  → **A3** → **[AF Limiter]**

Choose the range in which the camera will focus using autofocus. This is effective in situations in which an obstacle presents itself between the subject and the camera during the focus operation, causing drastic changes in focus. You can also use it to prevent the camera focusing on foreground objects when shooting through a fence, window, or the like.

Distance settings	Choose the range of focus distances available. The camera can store up to three settings for different situations. Distances are approximate and intended as guides only.
Release Priority	The shutter can still be released if the camera is unable to focus when [On] is selected for [AF Limiter] .

 AF Limiter is not available in the following cases.

- When the focus limiter is enabled on the lens
- When using focus bracketing
- While in the movie mode or recording a movie
- When **[AF]** or **[AF MF]** is selected for focus mode

Fine-Tuning Autofocus (AF Focus Adj.)

MENU → ⚙️ → A3 → [AF Focus Adj.]

Fine-tune phase-detection autofocus. Focus can be fine-tuned by up to ± 20 steps.

- ⓘ Normally there is no need to fine-tune autofocus using this item. Fine-tuning focus may prevent the camera focusing normally.
- ⓘ Focus fine-tuning has no effect in **[S-AF]** and **[S-AF MF]** modes.
- ⓘ This item is for still photography.

Off	Fine-tuning disabled.
Default Data	Fine-tune focus for all lenses.
Lens Data	Save fine-tuning values on a lens-by-lens basis. The camera can store fine-tuning values for up to 20 lenses. Focus for individual lenses can be fine-tuned in specific areas of the frame. In the case of zoom lenses, separate values can be stored for long and short focal lengths.

1. Highlight **[AF Focus Adj.]** in ⚙️ Custom Menu **A3** and press the **▶** button.

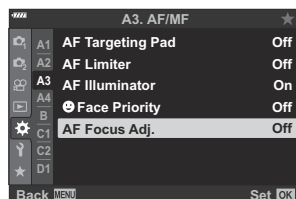

2. Highlight **[Default Data]** or **[Lens Data]** and press the **▶** button.



- If you selected **[Default Data]**, proceed to Step 5.
- To disable fine-tuning, highlight **[Off]** and press the **OK** button.

3. Highlight **[Create Lens Data Set]** and press the **OK** button.

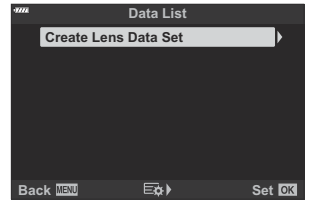

- You will be prompted to choose the area of the frame for which focus will be fine-tuned.

4. Use the Δ ∇ \triangleleft \triangleright buttons to choose an area of the frame and then press the **OK** button.



- With zoom lenses, you can press the **INFO** button to choose between long (telephoto) and short (wide) focal lengths.

5. Choose a fine-tuning value using the Δ ∇ buttons and press the **OK** button.

- The selected value will be saved. If you chose **[Default Data]**, the options shown in Step 2 will be displayed.
- If you chose **[Lens Data]**, the dialog shown in Step 3 will be displayed. The display will show the name of the lens for which the fine-tuning value was saved.
- Rotate the front dial to zoom in and check focus.
- Before pressing the **OK** button, press the shutter button to take a test shot and check focus.
- To save another fine-tuning value for the current lens, press the \triangleright button and repeat the process from Step 4.

6. To fine-tune focus for the same lens but in a different area of the frame, highlight the lens name using the Δ ∇ buttons and press the \triangleright button.







- Repeat the process from Step 4.

7. When the process is complete, press the **MENU** button repeatedly to exit the menus.

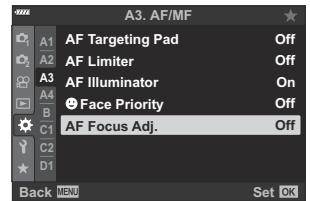

Deleting Saved Values

1. Highlight **[AF Focus Adj.]** in  Custom Menu **A3** and press the  button.





2. Highlight **[Lens Data]** using the   buttons and press the  button.

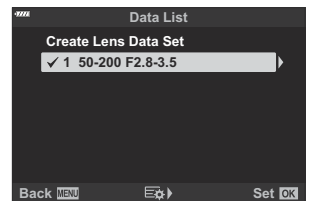

3. Use the   buttons to highlight the name of the lens you wish to delete from the fine-tuning list and then press the  button.



4. Highlight **[Delete]** using the   buttons and press the  button.

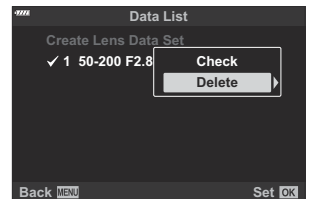

- A confirmation dialog will be displayed.

5. Highlight **[Yes]** using the   buttons and press the **OK** button.

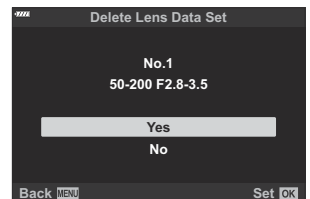

- The dialog shown in Step 3 will be displayed. Confirm that the lens name has been deleted.

ⓘ To disable AF fine-tuning without deleting the entries for the current lens, select **[Off]** for **[AF Focus Adj.]**.

🔗 The camera can store multiple values for each lens.

Enabling Fine-Tuning

Display the lens data list and place checks (✓) next to the items you wish to use.

Manual Focus Assist (MF Assist)

MENU → ⚙️ → A4 → [MF Assist]

This is a focus assist function for MF. When the focus ring is rotated, the edge of the subject is enhanced or a portion of the screen display is magnified. When you stop operating the focus ring, the screen returns to the original display.

Magnify	<p>Magnifies a portion of the screen.</p> <p>[Off]: Normal display.</p> <p>[On]: Magnifies a portion of the screen. The portion to be magnified can be set in advance using AF target. 🖱️ "Choosing a Focus Target (AF Target Point)" (P. 95)</p> <ul style="list-style-type: none">• Rotate the front or rear dial to zoom in or out during focus zoom.• Focus zoom is not available during movie recording or when [C-AF+MF] or [C-AF+TRMF] is selected for focus mode.
Peaking	<p>Displays clearly defined outlines with edge enhancement.</p> <p>[Off]: Normal display.</p> <p>[On]: Displays clearly defined outlines with edge enhancement. You can select the enhancement color and intensity. 🖱️ ⚙️ Custom Menu D3 > [Peaking Settings] (P. 281)</p> <p>🔊 Press the INFO button to change the color and intensity when peaking is displayed.</p> <p>⚠️ When peaking is in use, the edges of small subjects tend to be enhanced more strongly. This is no guarantee of accurate focusing.</p>
Focus Indicator	<p>Rotating the focus ring during manual focus displays an indicator showing the direction and approximate amount of rotation required to bring the subject into focus.</p> <p>[Off]: Normal display.</p> <p>[On]: Rotating the focus ring during manual focus displays an indicator showing the direction and approximate amount of rotation required to bring the subject into focus.</p> <p>⚠️ These indicators may be reversed in the case of third-party lenses equipped with a focus clutch, in which case you will need to change the option selected for [Focus Ring] (P. 273).</p> <p>⚠️ The focus indicator is not displayed when a lens with a Four Thirds mount is used.</p>

Adjusting Focus During Exposures (Bulb/Time Focusing)

MENU → ⚙️ → A4 → [Bulb/Time Focusing]

In mode **B** (bulb), you can adjust focus manually while the exposure is in progress. This allows you to defocus during the exposure or focus at the end of the exposure.

1. Highlight **[Bulb/Time Focusing]** in ⚙️ Custom Menu **A4** and press the **OK** button.







2. Highlight an option using the Δ ∇ buttons.
[Off]: The focus position cannot be adjusted manually during an exposure.
[On]: The focus position can be adjusted manually during an exposure.
3. Press the **OK** button to select the highlighted option.
 - ⚙️ Custom Menu **A4** will be displayed.
4. Press the **MENU** button repeatedly to exit the menu.

Assigning Roles to the Front and Rear Dials



(Dial Function)



MENU → → **B** → [Dial Function]

Choose the roles performed by the front and rear dials. You can also choose the function selected using the **Fn** lever (P. 321), as well as the operations performed during playback or when menus are displayed.

- The functions assigned using [ Button/Dial/Lever] > [ Fn Lever Function] in the  Video Menu (P. 233) take effect in  (movie) mode.

The roles that can be performed by the dials in photo shooting and  playback modes are listed below.

Available Roles	Function	Exposure mode				
		P	A	S	M	B
Ps	Program shift (P. 50).	✓	—	—	—	—
Shutter	Choose a shutter speed.	—	—	✓	✓	✓ ¹
FNo.	Adjust aperture.	—	✓	—	✓	✓
	Adjust exposure compensation.	✓	✓	✓	✓	✓
	Adjust flash compensation.	✓	✓	✓	✓	✓
ISO	Adjust ISO sensitivity.	✓	✓	✓	✓	✓
WB	Adjust white balance.	✓	✓	✓	✓	✓
CWB Kelvin	Choose a color temperature when CWB (custom) is selected for white balance.	✓	✓	✓	✓	✓
Off	None.	✓	✓	✓	✓	✓





Available Roles	Function	Exposure mode				
		P	A	S	M	B
 /Value	Move the cursor up or down or highlight values or options while menus are displayed.			—		
	Move the cursor left or right while menus are displayed.					
 (index/ playback zoom)	Zoom in or out or switch to the index display during playback.			—		
Prev/Next	View the next or previous image during playback.					





1 Switch between bulb, time, and live composite.

Customizing the Fn Lever (Fn Lever Function)

MENU → ⚙️ → **B** → [Fn Lever Function]

Choose the role played by the **Fn** lever.

- The functions assigned to controls using this item are available only in modes **P**, **A**, **S**, **M**, and **B** (still photography modes). The functions assigned using [ **Button/Dial/Lever**] > [ **Fn Lever Function**] in the  **Video Menu** (P. 233) take effect in  (movie) mode.

mode1	Switch the functions of the front and rear dials. The functions for Positions 1 and 2 conform to the setting selected for [ Dial Function] (P. 319).
mode2	Switch between two groups of settings previously selected for [AF Mode], [AF Target Mode], and [AF Target Point]. <ul style="list-style-type: none">• You can choose the options selected by pressing the  button.
mode3	Toggle the shooting mode. You can switch to  (movie) mode without rotating the mode dial. ⓘ The Fn lever cannot be used to perform the function assigned using [ Fn Lever Function].
Off	The Fn lever function is turned off.

- ⓘ The **Fn** lever cannot be used to perform the selected function when [**Power 1**] or [**Power 2**] is selected for [**Fn Lever/Power Lever**] in  **Custom Menu** **B** (P. 275).

Burst Shooting Options ([L Settings]/ [H Settings])



MENU → **⚙️** → **C1** → [[L Settings]] / [[H Settings]]



Adjust settings for sequential shooting modes, including the maximum frame advance rate and number of shots per burst. Shooting ends if the maximum number of shots is reached while the shutter button is pressed all the way down.





Choose the advance rate and number of shots per burst for [L] (sequential low) and [H] (sequential high) modes.

<p>[L] Settings (sequential low options)</p>	<p>Choose the frame rate and maximum number of shots per burst for [L] (sequential low), [L] (anti-shock sequential low), and [L] (silent sequential low) modes. You can also adjust settings for ^{Pro}CapL (Pro Capture Low) mode (P. 107).</p> <ul style="list-style-type: none">• [L] and [L] modes: [Max fps]: 1–6 fps [Frame Count Limiter]: 2–99, Off (no limit)• [L] mode: [Max fps]: 1–10 fps [Frame Count Limiter]: 2–99, Off (no limit)• ^{Pro}CapL mode: [Pre-shutter Frames]: 0–14 [Frame Count Limiter]: 2–99, Off (no limit) Includes shots captured before recording begins.
--	--



 H Settings
(sequential high options)

Choose the frame rate and maximum number of shots per burst for  (sequential high) and  (silent sequential high) modes. You can also adjust settings for  (Pro Capture High) mode (P. 107).

-  mode:
 - [Max fps]:** 5–10 fps
 - [Frame Count Limiter]:** 2–99, Off (no limit)
-  mode:
 - [Max fps]:** 15, 20, or 30 fps
 - [Frame Count Limiter]:** 2–99, Off (no limit)
-  mode:
 - [Max fps]:** 15, 20, or 30 fps
 - [Pre-shutter Frames]:** 0–14
 - [Frame Count Limiter]:** 2–99, Off (no limit)Includes shots captured before recording begins.

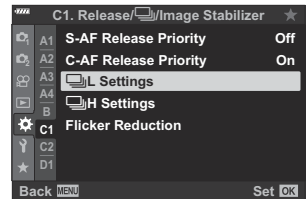
1. Highlight [ L Settings] or [ H Settings] in  Custom Menu  and press the **OK** button.



2. Highlight an option using the   buttons and press the  button.

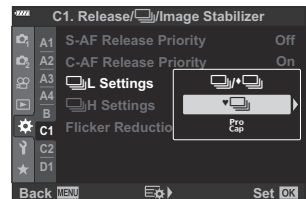

- The camera will display options for the selected item.

3. Choose settings for **[Pre-shutter Frames]** or **[Max fps]**.

If you selected **[], [], or []** in Step 2:

- Highlight **[Max fps]** using the Δ ∇ buttons and press the \triangleright button.
- Highlight an item using the Δ ∇ buttons and press the **OK** button.

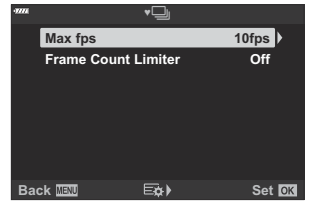

If you selected **[]** in Step 2:

- Highlight **[Pre-shutter Frames]** using the Δ ∇ buttons and press the \triangleright button.
- Highlight an option using the Δ ∇ buttons and press the **OK** button.

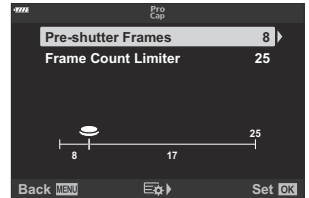

4. Choose the maximum number of shots per burst (**[Frame Count Limiter]**).

- Highlight **[Frame Count Limiter]** using the Δ ∇ buttons and press the \triangleright button.

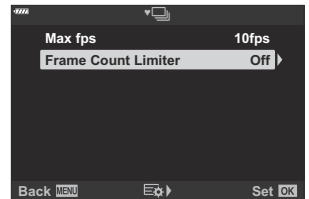

- To keep shooting as long as the shutter release button is pressed all the way down, select **[Off]**.
- To choose a maximum number of shots, highlight the current setting and press the \triangleright button to display options. Highlight digits using the \triangleleft \triangleright buttons and use the Δ ∇ buttons to change.
- The maximum number of shots per burst includes shots captured while the shutter button is pressed halfway. [“Shooting without a release time lag \(Pro Capture shooting\)” \(P. 107\)](#)
- Press the **OK** button to save changes to settings.

5. Press the **OK** button.

- Custom Menu **C1** will be displayed.

6. Press the **MENU** button repeatedly to exit the menu.

Reducing Flicker (Flicker Reduction)

MENU → ⚙ → C1 → [Flicker Reduction]

When shooting under fluorescent or other artificial workplace or outdoor lighting, you may notice flicker in the live view display or uneven exposure in photos taken at fast shutter speeds. This item reduces these effects.

Reducing Flicker in Live View (Anti-Flicker LV)

Reduce flicker under fluorescent lighting and the like. Choose this option if flicker makes the display difficult to view.

Auto	The camera detects and reduces flicker.
50Hz	Reduce flicker under workplace or outdoor lighting powered by alternating current with a frequency of 50 Hz.
60Hz	Reduce flicker under workplace or outdoor lighting powered by alternating current with a frequency of 60 Hz.
Off	Flicker reduction off. <ul style="list-style-type: none">This option is not available when [On] is selected for [Anti-Flicker Shooting] (P. 327).

1. Highlight **[Flicker Reduction]** in ⚙ Custom Menu C1 and press the **OK** button.

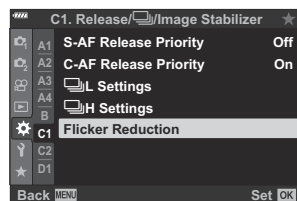

2. Highlight **[Anti-Flicker LV]** using the Δ ∇ buttons and press the \triangleright button.

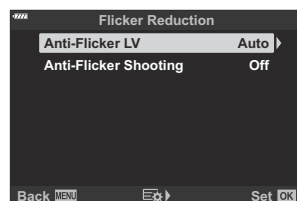

- **[Anti-Flicker LV]** options will be displayed.

3. Highlight an option using the Δ ∇ buttons and press the **OK** button.



- **[Flicker Reduction]** options will be displayed.

4. Press the **MENU** button repeatedly to exit the menu.

Reducing Flicker in Photographs (Anti-Flicker Shooting)

You may notice uneven exposure in photos taken under flickering light. When this option is enabled, the camera will detect the flicker frequency and adjust the timing of the shutter release accordingly. This feature applies to photos taken with the mechanical shutter.

1. Highlight **[Flicker Reduction]** in  Custom Menu **C1** and press the **OK** button.

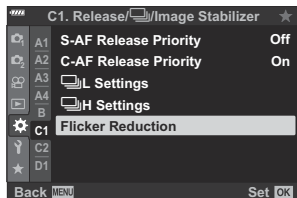

2. Highlight **[Anti-Flicker Shooting]** using the Δ ∇ buttons and press the \triangleright button.

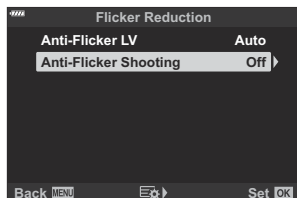

- **[Anti-Flicker Shooting]** options will be displayed.

3. Highlight **[On]** or **[Off]** using the Δ ∇ buttons and press the **OK** button.

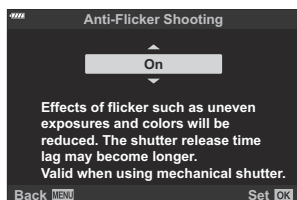

- **[Flicker Reduction]** options will be displayed.

4. Press the **MENU** button repeatedly to exit the menu.

- A **FLK** icon appears in the display when **[On]** is selected.



- ⓘ This option does not take effect in modes that use the electronic shutter, including silent modes, High Res Shot, and Pro Capture modes.
- ⓘ The camera may be unable to detect flicker at some settings. Normal release timing will be used if flicker is not detected.
- ⓘ Normal release timing is used at slow shutter speeds.
- ⓘ Enabling flicker reduction may cause release lag, slowing the frame advance rate during burst photography.

Choosing the control panel displays

(📷 Control Settings)

MENU → ⚙️ → D1 → [📷 Control Settings]

Choose the control panel displays available in each shooting mode. Select each of the shooting modes and press the **OK** button to place a check next to each of the displays you wish to have available.

1. Highlight [📷 Control Settings] in ⚙️ Custom Menu D1 and press the **OK** button.

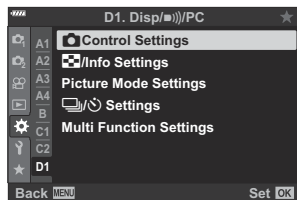

2. Highlight the desired shooting mode using the Δ ∇ buttons and press \triangleright .

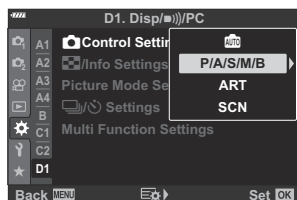

- Control options for the selected mode will be displayed.

3. Highlight an option using the Δ ∇ buttons and press the **OK** button.

- Selected items are marked with a check (✓). The displays marked with a check will be available in the selected shooting mode.

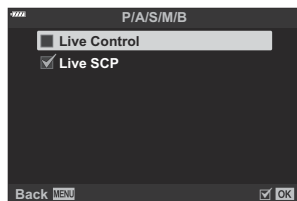

4. Press the **MENU** button repeatedly to exit the menus.

🔗 The control panel displays for movie mode can be selected using [📷 Display Settings] > [📷 Control Settings] in the 📷 Video Menu. 📷 Video Menu > [📷 Display Settings] > [📷 Control Settings] (P. 233)

Displaying On-Screen Controls

Press the **OK** button to display a control panel and use the **INFO** button cycle through the available displays.

ⓘ Only control panels selected in the [📷 **Control Settings**] menu will be displayed.

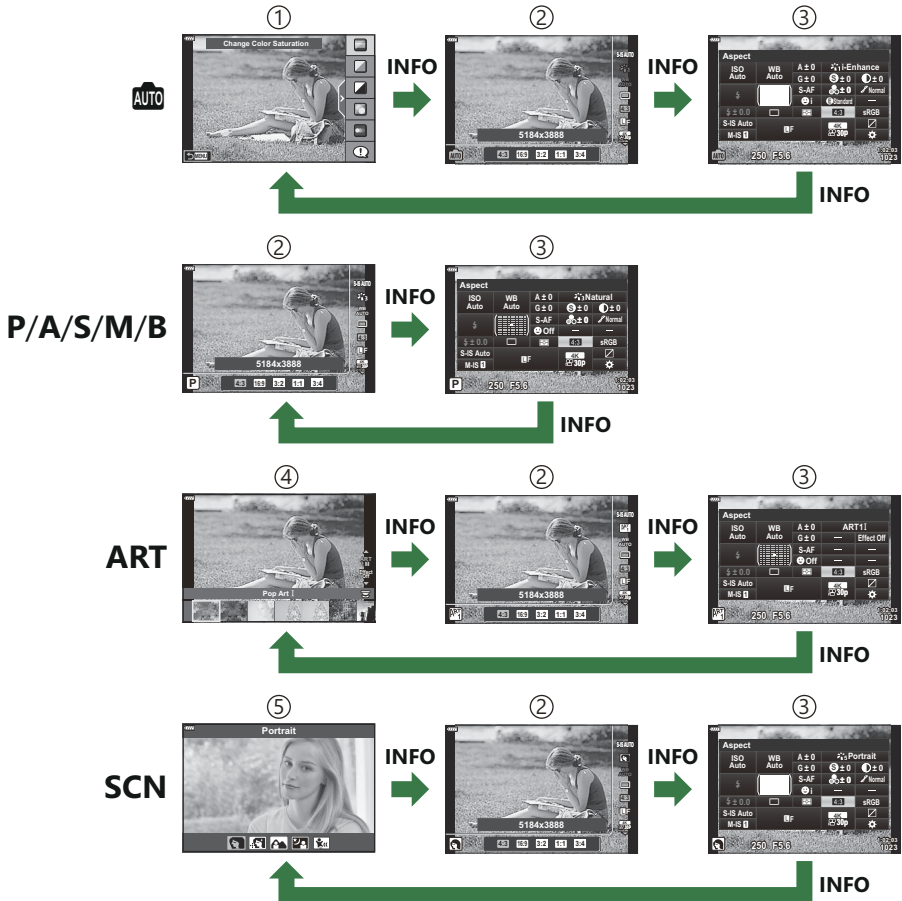

① Live Guide (P. 64)

② Live Control (P. 331)

③ LV super control panel (P. 115)

④ Art Menu (P. 73)

⑤ Scene Menu (P. 67)

📷 The on-screen controls available in movie mode can be selected using [📷 **Display Settings**] > [📷 **Control Settings**] in the 📷 Video Menu. 📷 **Video Menu** > [📷 **Display Settings**] > [📷 **Control Settings**] (P. 233)

Live Controls



- ① Settings
- ② Functions

Available settings



- Image stabilizer (P. 134)
- Picture mode (P. 154, P. 206)
- Art filter mode¹ (P. 73)
- Scene mode² (P. 67)
- White balance (P. 129)
- Sequential shooting/self-timer (P. 101)
- Aspect ratio (P. 138)
- Image quality
 - Photos (P. 139)
 - Movies (P. 242)
-  mode³ (P. 238)
- Flash mode (P. 149)
- Flash intensity control (P. 153)
- Metering mode (P. 124)
- AF mode (P. 118)
- ISO sensitivity (P. 117)
- Face priority (P. 126)
- Movie sound (P. 246)

1 Displayed in **ART** mode.

2 Displayed in **SCN** mode.

3 Displayed in movie mode.

 Some functions cannot be used depending on the shooting mode.

 Live controls are available in **AUTO**, **P**, **A**, **S**, **M**, **B**, **ART**, and **SCN** modes when **[Live Control]** is selected in the **[Camera Control Settings]** display.   Custom Menu **D1** > **[Camera Control Settings]** (P. 329)

1. Press the **OK** button to display live controls.
 - Press the **OK** button again to hide live controls.
2. Highlight items using the Δ ∇ buttons, choose the desired option using the \triangleleft \triangleright buttons, and then press the **OK** button.
 - The setting is confirmed if you leave the camera as-is for 8 seconds.

Adding information displays ([Info] /Info Settings)

MENU → ⚙ → D1 → [Info] /Info Settings]

▶ Info (Playback information displays)

Use [▶ Info] to add the following playback information displays. The added displays are displayed by repeatedly pressing the **INFO** button during playback. You can also choose to not show displays that appear at the default setting.

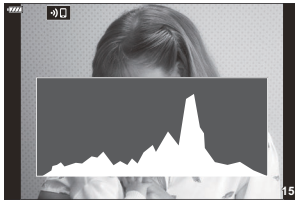

Histogram display







Highlight & Shadow display

Highlight & Shadow display

Areas above the upper limit of brightness for the image are shown in red, those below the lower limit in blue. ⚙ Custom Menu D3 > [Histogram Settings] (P. 281)

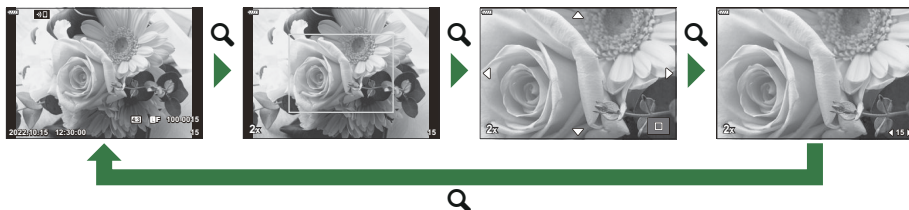

Info (Magnified playback information display)

The magnified playback information displays can be set with [  Info]. If [] (Magnify) is currently assigned to a control (P. 167), you can cycle through the chosen displays by repeatedly pressing the  button during playback. You can also choose to not show displays that appear at the default setting.



LV-Info (Shooting information displays)

Choose the info shown in the live view shooting display.  "Switching the information display" (P. 41)

To add highlights and shadows to the [LV-Info] display, press the  button to place a check next to [Custom1] or [Custom2]. The added displays can be viewed by repeatedly pressing the **INFO** button during shooting. You can also choose to not show displays that appear at the default setting. To choose the items displayed when the shutter button is pressed halfway, highlight [Image Only] in the [LV-Info] menu and press the  button.

On	Shooting info is displayed while the shutter button is pressed halfway.
Off	Shooting info is not displayed while the shutter button is pressed halfway.

LV OFF-Info (Shooting information displays)

Choose a shooting display (P. 41).

Settings (Index/calendar display)

You can change the number of frames to be displayed on the index display and set to not display the screens that are set to be displayed by default with [ **Settings**]. Screens with a check can be selected on the playback screen using the rear dial.

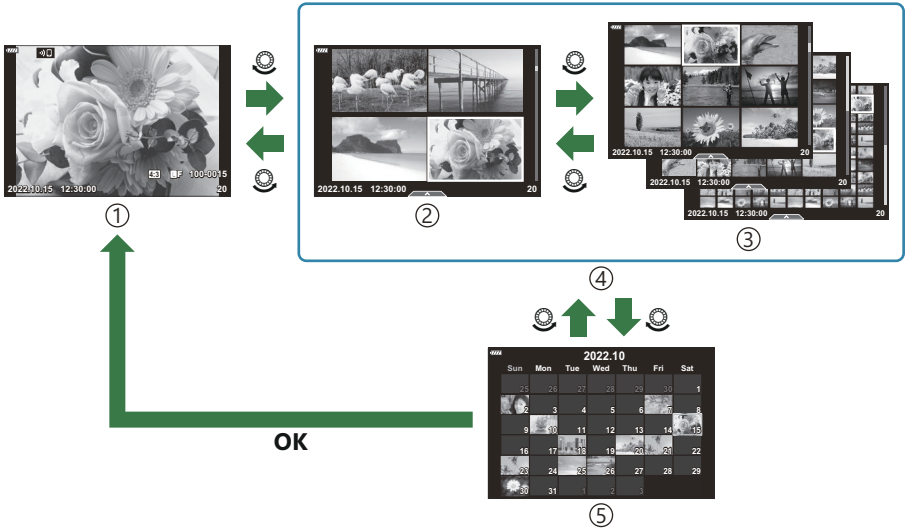

- ① Single-frame playback
- ② 4 frames
- ③ 9, 25, or 100 frames

- ④ Index display
- ⑤ Calendar display

Choosing the Playback Zoom Ratio

(Default Setting)

MENU →  →  → [  **Default Setting**]

Choose the starting zoom ratio for playback zoom (close-up playback).

Recently	Zoom in to the most recently selected zoom ratio.
Equally Value	Images are displayed at a zoom ratio of 1:1. A  icon appears in the monitor.
×2, ×3, ×5, ×7, ×10, ×14	Choose the starting zoom ratio.

Selfie Assist (Selfie Assist)

MENU → **⚙️** → **D3** → **[Selfie Assist]**

Choose the display used when the monitor is reversed for self-portraits.

On	When reversed for self-portraits, the monitor shows a mirror image of the view through the lens.
Off	The display does not change when the monitor is reversed.

1. Select **[On]** for **[Selfie Assist]** in **⚙️** Custom Menu **D3**.

2. Turn the monitor towards you.

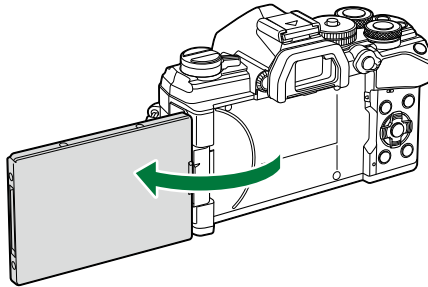

Viewing camera images on TV (HDMI)

MENU → **⚙️** → **D4** → **[HDMI]**

Use the separately sold cable with the camera to playback recorded images on your TV. This function is available during shooting. Connect the camera to an HD TV using an HDMI cable to view high-quality images on a TV screen.

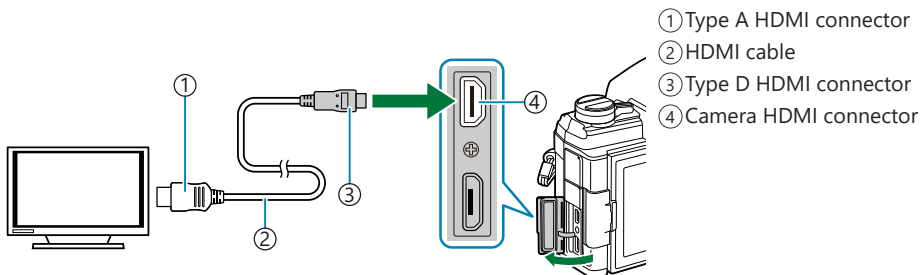

Connect the TV and camera and switch the input source of the TV.

- If **[On]** is selected for **[HDMI Control]** (P. 388), the camera monitor will turn off when an HDMI cable is connected.

🔗 For information on switching to HDMI input, see the manual provided with the TV.

🔗 If the camera is connected via an HDMI cable, you will be able to choose the digital video signal type. Choose a format that matches the input format selected with the TV.

⚠️ Depending on TV settings, the image may be cropped and some indicators may not be visible.

C4K	The signal is output in 4K digital cinema (4096 × 2160) format.
4K	If possible, the signal is output in 4K (3840 × 2160).
1080p	If possible, the signal is output in Full HD (1080p).
720p	If possible, the signal is output in HD (720p).
480p/576p	The signal is output in 480p/576p format.

⚠️ Do not connect the camera to other HDMI output devices. Doing so may damage the camera.

⚠️ HDMI output is disabled while the camera is connected to a computer via USB.

⚠️ When **[Record Mode]** is selected for **[Output Mode]**, movies will be output at the resolution selected during recording. No image will be displayed if the TV does not support the selected frame size. 🖱️ **Video Menu** > **[HDMI Output]** > **[Output Mode]** (P. 233)

ⓘ If [4K] or [C4K] is selected, 1080p priority format will be used during still photography.

Using the TV remote control

The camera can be operated by a TV remote control when connected to a TV that supports HDMI control.  ["Using a TV Remote \(HDMI Control\)" \(P. 388\)](#)

The camera monitor turns off.

- You can operate the camera by following the operation guide displayed on the TV.
- During single-frame playback, you can display or hide the information display by pressing the "Red" button, and display or hide the index display by pressing the "Green" button.

ⓘ Some televisions may not support all features.

Choosing a USB Connection Mode (USB Mode)

MENU →  →  → **[USB Mode]**



Choose how the camera functions when connected to external devices via USB.

Select	You will be prompted to choose a connection mode each time a USB cable is connected.
Storage	The camera functions as an external storage device. The data on the camera memory card can be copied to the computer.
MTP	The pictures on the memory card can be viewed or copied to the computer using standard software supplied with Windows (P. 371).
Webcam	The camera can be connected to a computer for use as a webcam for online meetings or live streaming (P. 374). Video and audio are transmitted directly from the camera via a simple USB connection, obviating the need for special software or drivers (USB streaming).

Live Bulb Update Frequency (Live Bulb)

MENU →  →  → **[Live Bulb]**



Choose the frequency with which the display is updated during live bulb photography in mode **B** (bulb). The display will be refreshed at the selected interval while live bulb photography is in progress, allowing you to view the results in the display.

 **[Live Bulb]** options can also be displayed by pressing the **MENU** button when the mode dial is rotated to **B** and **[BULB]** is selected for shutter speed.  [“Long Exposures \(B: Bulb/Time\)” \(P. 58\)](#)

Live Time Update Frequency (Live Time)

MENU →  →  → **[Live Time]**

Choose the frequency with which the display is updated during live time photography in mode **B** (bulb). The display will be refreshed at the selected interval while live time photography is in progress, allowing you to view the results in the display.

 **[Live Time]** options can also be displayed by pressing the **MENU** button when the mode dial is rotated to **B** and **[TIME]** is selected for shutter speed.  [“Long Exposures \(B: Bulb/Time\)” \(P. 58\)](#)

Choosing the Shutter Speed (Composite Settings)

MENU → ⚙ → E2 → [Composite Settings]

The exposure time for each exposure made during live composite photography can be chosen in advance using the menus.

1. Highlight **[Composite Settings]** in ⚙ Custom Menu **E2** and press the **OK** button.

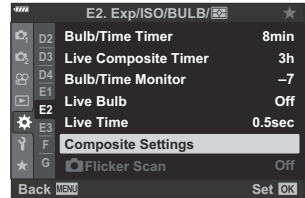

2. Highlight an option using the Δ ∇ buttons.

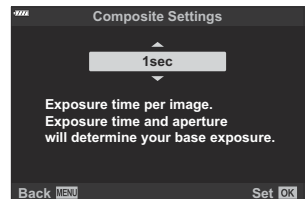

- Choose an exposure time of from 1/2 to 60 s.

3. Press the **OK** button to select the highlighted option.
 - ⚙ Custom Menu **E2** will be displayed.

4. Press the **MENU** button repeatedly to exit the menus.

- The maximum exposure time can be selected using **[Live Composite Timer]** in ⚙ Custom Menu **E2** (P. 285). The default setting is **[3h]**.

🔗 This item applies during still photography in **B** (bulb) mode. See “[Lighten Blending \(B: Live Composite Photography\)](#)” (P. 62) for more information on composite photography.

🔗 **[Composite Settings]** options can also be displayed by pressing the **MENU** button when the mode dial is rotated to **B** and **[LIVE COMP]** is selected for shutter speed. 🗑 “[Lighten Blending \(B: Live Composite Photography\)](#)” (P. 62)

Reducing Flicker Under LED Lighting

(📷 Flicker Scan)

MENU → ⚙️ → E2 → [📷 Flicker Scan]

Banding may occur in photographs taken under LED lighting. Use [📷 Flicker Scan] to optimize shutter speed while viewing banding in the display.

- ⓘ This item can be used in **S**, **M**, and silent mode and with High Res Shot and Pro Capture shooting.
- ⓘ The range of available shutter speeds is reduced.

1. Choose shooting and drive modes.

- Choose shooting mode **S** or **M**.
- Choose one of the following drive modes:
 - Silent mode (📷, 📷L, 📷H, 📷2s, 📷2s, 📷c)
 - High Res Shot (📷)
 - Pro Capture (ProCapL, ProCapH)

2. Highlight [📷 Flicker Scan] in ⚙️ Custom Menu E2 and press the **OK** button.

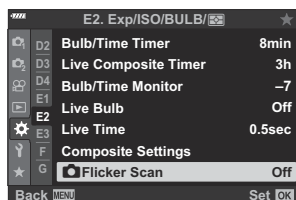

3. Highlight [On] using the Δ ∇ buttons and press the **OK** button.

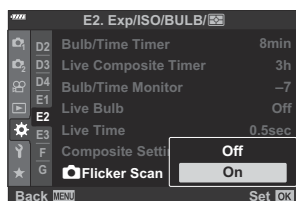

- The camera will return to the previous menu.

4. Press the **MENU** button repeatedly to exit the menu.

- The camera will exit to the shooting display. A **Flicker Scan** icon will be displayed.



5. Choose a shutter speed while viewing the display.

- Choose a shutter speed using the front or rear dial or the Δ ∇ buttons. If desired, the shutter speed can be selected by keeping Δ ∇ pressed.
- You can also rotate the front dial to adjust shutter speed in the exposure increments selected for **[EV Step]** in \ast Custom Menu **[E]**.
- Continue adjusting shutter speed until banding is no longer visible in the display.
- Press the **INFO** button; the display will change and the **Flicker Scan** icon will no longer be displayed. You can adjust aperture and exposure compensation. Do so using the front or rear dial or the arrow pad.
- Press the **INFO** button repeatedly to return to the flicker scan display.

6. Take pictures once settings have been adjusted to your satisfaction.

 Focus peaking, the LV super control panel, and live controls are not available in the flicker scan display. To view these items, first press the **INFO** button to exit the flicker scan display.

Fine-Tuning Exposure (Exposure Shift)



MENU →  →  → **[Exposure Shift]**

Fine-tune exposure. Use this option if you want the results of auto exposure to be consistently brighter or darker.

 Fine-tuning is not normally required. Use only as necessary. In normal circumstances, exposure can be adjusted using exposure compensation ([P. 89](#)).

 Fine-tuning exposure reduces the amount of exposure compensation available in the direction (+ or -) exposure was fine-tuned.

Exposure fine-tuning can be applied to the following metering methods.

Metering		Fine-tuning amount
	(digital ESP)	-1 to +1 EV in steps of 1/6 EV
	(center-weighted averaging)	
	(spot)	

Shutter speeds when the flash fires (⚡X-Sync./⚡Slow Limit)

MENU → ⚙ → F → [⚡X-Sync.]/[⚡Slow Limit]

You can set shutter speed conditions for when the flash fires.

Shooting mode	Flash firing shutter speed	Upper limit	Lower limit
P	The camera automatically sets the shutter speed.	[⚡ X-Sync.] setting	[⚡ Slow Limit] setting
A			
S	The set shutter speed		No lower limit
M			

Combinations of JPEG image sizes and compression rates (◀ Set)

MENU → **⚙** → **G** → [**◀ Set**]

You can set the JPEG image quality by combining image size and compression rate.

Image size (pixel count)	Compression rate			Application
	Super Fine	Fine	Normal	
Large (5184×3888) ¹	L SF ¹	L F ¹	L N ¹	Select for the print size
Middle (3200×2400) ¹	M SF	M F	M N ¹	
Middle (1920×1440)				
Small (1280×960)	S SF	S F	S N	For small prints and use on a website
Small (1024×768)				

1 Default

Saving lens info (Lens Info Settings)

MENU → ⚙️ → H1 → [Lens Info Settings]

The camera can store information for up to 10 lenses that do not conform to the Micro Four Thirds or Four Thirds system standards. These data also supply the focal length used for the image stabilization and keystone compensation features.

1. Select **[Create Lens Information]** for **[Lens Info Settings]** in ⚙️ Custom Menu H1.
 2. Select **[Lens Name]** and enter a lens name. After entering a name, highlight **[END]** and press the **OK** button.
 3. Use $\Delta \nabla \triangleleft \triangleright$ to choose the **[Focal Length]**.
 4. Use $\Delta \nabla \triangleleft \triangleright$ to choose the **[Aperture Value]**.
 5. Highlight **[Set]** and press the **OK** button.
- The lens will be added to the lens info menu.
 - When a lens that does not supply info automatically is attached, the info used is indicated by checks (✓). Highlight lenses to which you want to add checks (✓) and press the **OK** button.

Selecting the display style of the viewfinder (EVF Style)

MENU → **⚙** → **📺** → **[EVF Style]**

Style 1/2: Similar to film camera viewfinder displays.

Style 3: The same as the monitor display.



Style 1/Style 2



Style 3

Viewfinder display when shooting using the viewfinder (Style 1/Style 2)

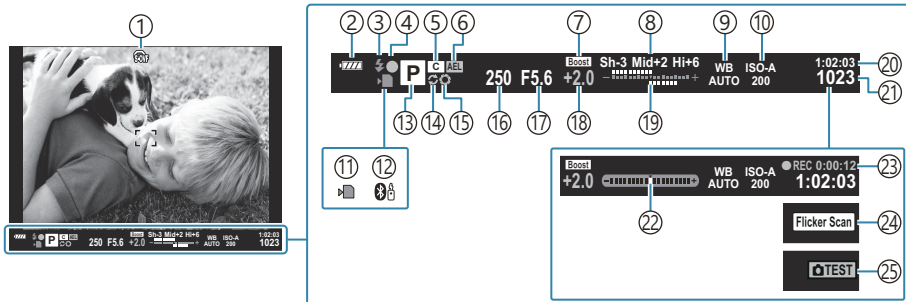

- ① OVF simulation ¹
 - Custom Menu **1** > **[S-OVF]** (P. 293)
- ② Battery level (P. 32)
- ③ Flash mode (blinks while flash is charging, lights when charging is complete) (P. 147, P. 149)
- ④ AF confirmation mark (P. 43)
- ⑤ Custom mode (P. 77, P. 79)
- ⑥ AE lock (P. 100, P. 299)
- ⑦ Live view boost
 - Custom Menu **D2** > **[Live View Boost]** (P. 280)
- ⑧ Highlight & shadow control (P. 166)
- ⑨ White balance (P. 129)
- ⑩ ISO sensitivity (P. 98, P. 117)
- ⑪ Card write indicator (P. 23, P. 28)
- ⑫ Active **Bluetooth**[®] connection (P. 359)
- ⑬ Shooting mode (P. 43)
- ⑭ Pro Capture active (P. 107)
- ⑮ Preview (P. 167)
- ⑯ Shutter speed (P. 48, P. 51, P. 53, P. 55)
- ⑰ Aperture value (P. 48, P. 51, P. 53, P. 55)
- ⑱ Exposure compensation value (P. 89)
- ⑲ Top: Flash intensity control (P. 153)
Bottom: Exposure compensation (P. 89)
- ⑳ Available recording time (P. 424)
- ㉑ Number of storable still pictures (P. 422)
- ㉒ Level gauge ² (P. 42)
- ㉓ Recording time (displayed during recording) (P. 83)
- ㉔ Flicker scan (P. 240, P. 343)
- ㉕ Test shot (P. 169)

1 Shown in viewfinder only.

2 Displayed when the shutter button is pressed halfway. Custom Menu **1** > **[Half Way Level]** (P. 293)

Viewfinder Info Display Options (Info Settings)

MENU → ⚙️ → ⓘ → [Info Settings]

Just as you can with the monitor, you can display a histogram or level gauge in the viewfinder by pressing the **INFO** button. Choose the information that can be viewed by pressing the **INFO** button in the viewfinder display. This item is used to choose the types of display available. It takes effect when **[Style 1]** or **[Style 2]** is selected for **[EVF Style]**.

- The option selected for [ Display Settings] > [ Info Settings] in the  Video Menu (P. 233) takes effect in  (movie) mode.

Basic Information	The camera displays icons and the like showing camera settings.
Custom1/Custom2	In addition to the base display, you can opt to view or hide: <ul style="list-style-type: none">• []: A histogram superimposed on the display in the viewfinder.• [Highlight&Shadow]: Tints applied to over- and under-exposed areas.• [Level Gauge]: The level gauge.

- Items marked with checks (✓) appear in the viewfinder display.
- To choose the custom displays available in the viewfinder, highlight **[Custom1]** or **[Custom2]** and press ▷ on the arrow pad.

Button Hold Options (Press-and-hold Time)

MENU → ⚙️ → J1 → [Press-and-hold Time]

Choose how long buttons must be pressed to perform resets and other similar functions for various features. For ease of use, button hold times can be set separately for different features.

Available Features

- End LV 🔍
- Reset LV 🔍 Frame
- End 📺 (movie teleconverter zoom frame display)
- Reset 📺 Frame (movie teleconverter zoom frame position)
- Reset 📺
- Reset 📺 (flash compensation)
- Reset 📺 (highlight and shadow control)
- Reset 🎨 (color creator)
- Reset [:::]
- Call EVF Auto Switch
- End 📺 🔍
- End 📺
- Reset 📺
- Switch 📺 Lock (touch controls)
- Call BKT Settings
- End Flicker Scan

Correcting Fisheye Distortion (Fisheye Compensation)

MENU → ⚙️ → J1 → [Fisheye Compensation]

Correct distortion caused by fisheye lenses to give photos the appearance of pictures taken with a wide-angle lens. The amount of correction can be selected from three different levels. You can also opt simultaneously to correct distortion in photos taken under water.

- This option is available in **P**, **A**, **S**, **M**, and **B** modes.

ⓘ This option is only available with compatible fisheye lenses.

As of October 2022, it could be used with the M.ZUIKO DIGITAL ED 8mm F1.8 Fisheye PRO.

Angle	When fisheye correction is performed, the picture is cropped to eliminate blacked-out areas. Choose from three different crops.
 Correction	Choose whether to correct distortion in photos taken under water in addition to the correction performed using [Angle] .

1. Highlight **[Fisheye Compensation]** in ⚙️ Custom Menu **J1** and press the **OK** button.



2. Highlight **[On]** using the Δ ∇ buttons and press the \triangleright button.



- **[Angle]** and ** Correction** will be displayed.

3. Highlight an item using the Δ ∇ buttons and press the \triangleright button.

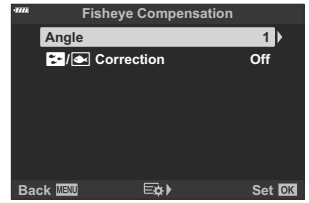

4. Highlight an option using the Δ ∇ buttons.

ⓘ If you are not taking photos under water, choose **[Off]** for **[/ Correction]**.

5. Press the **OK** button.

- **[Fisheye Compensation]** options will be displayed.

6. Press the **OK** button repeatedly to exit to Custom Menu **[1]**.

- After confirming that **[On]** is selected for **[Fisheye Compensation]**, press the **MENU** button to exit the menus.
- When fisheye compensation is enabled, a icon will be displayed together with the selected crop.



7. Take pictures.

- ⓘ Pictures taken with **[RAW]** selected for image quality are recorded in RAW + JPEG format. Fisheye compensation is not applied to the RAW image.
- ⓘ Focus peaking is not available in the fisheye compensation display.
- ⓘ AF-target selection is restricted to single- and small-target modes.
- ⓘ The following cannot be used:
 - live composite photography, burst photography, bracketing, HDR, multiple exposure, the live ND filter, keystone compensation, the digital teleconverter, movie recording, **[C-AF]**, **[C-AF MF]**, **[C-AF+TR]**, and **[C-AF+TR MF]** AF modes, **[e-Portrait]** and art filter picture modes, the custom self-timer, and High Res Shot.

Connecting the Camera to External Devices

Connecting to External Devices

A number of tasks can be accomplished by connecting the camera to an external device such as a computer or smartphone.  ["Connecting to Smartphones" \(P. 358\)](#), ["Copying pictures to a computer" \(P. 371\)](#), ["Connection" \(P. 377\)](#), ["Connecting the Camera to TVs or External Displays \(HDMI\)" \(P. 384\)](#)

Precautions for Using Wi-Fi and Bluetooth®

Disable wireless LAN and **Bluetooth®** in countries, regions, or locations in which their use is prohibited.

The camera is equipped with wireless LAN and **Bluetooth®**. Use of these features in countries outside the region of purchase may violate local wireless regulations.

Some countries and regions may prohibit the acquisition of location data without prior governmental permission. In some sales areas, the camera may consequently ship with location data displays disabled.

Each country and region has its own laws and regulations. Check them before traveling and observe them while abroad. Our company assumes no liability for any failure on the part of the user to observe local laws and regulations.

Disable Wi-Fi on airplanes and in other locations where their use is prohibited.  [“Disabling the Camera’s Wireless Functions” \(P. 357\)](#)

- ① Wireless transmissions are vulnerable to interception by third parties. Use wireless features with this in mind.
- ① The wireless transceiver is located in the camera grip. Keep it as far away as practicable from metal objects.
- ① When transporting the camera in a bag or other container, be aware that the contents of the container or the materials of which it is constructed may interfere with wireless transmissions, which can prevent the camera connecting to a smartphone.
- ① Wi-Fi connections increase the drain on the batteries. The connection may be lost during use if the batteries are low.
- ① Devices such as microwave ovens and cordless phones that generate radio-frequency emissions, magnetic fields, or static electricity may slow or otherwise interfere with wireless data transmission.
- ① Some wireless LAN features are unavailable when the memory card write-protect switch is in the “LOCK” position.



Disabling the Camera's Wireless Functions



Disable the camera's wireless (Wi-Fi/ **Bluetooth**[®]) functions.

1. Select **[Wi-Fi/Bluetooth Settings]** in the **Y** Setup Menu and press **▷**.
2. Select **[Wireless Functions]** and press **▷**.
3. Select **[Off]** and press the **OK** button.

 The following functions will be disabled.

- **[Device Connection]** (P. 359), **[Power-off Standby]** (P. 362), and **[Bluetooth]** (P. 361)

 To disable wireless LAN/**Bluetooth**[®] only while the camera is off, select **[Off]** for **[Wi-Fi/Bluetooth Settings]** > **[Power-off Standby]** in the **Y** Setup Menu.  ["Wireless Settings for When the Camera Is Off"](#) (P. 362)

 To disable wireless connection standby and terminate wireless transmissions when the camera is turned on, select **[Off]** for **[Wi-Fi/Bluetooth Settings]** > **[Bluetooth]** in the **Y** Setup Menu.  ["Wireless Connection Standby Setting for When the Camera Is On"](#) (P. 361)

Connecting the Camera to a Smartphone

Connecting to Smartphones

Use the camera's wireless LAN (Wi-Fi) and **Bluetooth**[®] features to connect to a smartphone, where you can use the dedicated app to enhance your enjoyment of the camera both before and after shooting. Once a connection has been established, you can download and take pictures remotely and add position information to images.

- Operation is not guaranteed on all smartphones.

Things you can do with the specified app, OM Image Share

- **Download images from the camera to the smartphone**

Download pictures marked for sharing (P. 190) to your smartphone.

You can also use the smartphone to select images for download from the camera.

- **Remote shooting from a smartphone**

You can remotely operate the camera and shoot using a smartphone.

- **Beautiful image processing**

Use intuitive controls to apply impressive effects to images downloaded to your smartphone.

- **Addition of GPS tags to camera images**



Using the smartphone's GPS function, you can add position information when taking pictures with the camera.

For details, visit our website.

Pairing the Camera and Smartphone



Follow the steps below when connecting the devices for the first time.

- Adjust pairing settings using the OM Image Share app, not the settings app that is part of the smartphone operating system.

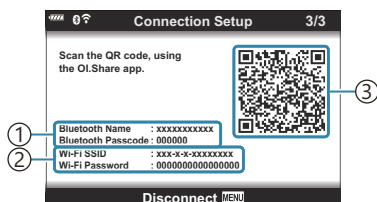
1. Launch the copy of the dedicated OM Image Share app previously installed on your smartphone.
2. Select **[Device Connection]** in the  Playback Menu and press .
 - You can also connect by tapping  in the monitor.
3. Follow the on-screen guide to adjust **Wi-Fi/Bluetooth** settings.
 - The **Bluetooth** local name and passcode, the Wi-Fi SSID and password, and a QR code are displayed in the monitor.



- ① **Bluetooth** local name
Bluetooth Passcode
- ② Wi-Fi SSID
Wi-Fi Password
- ③ QR code

4. Tap the camera icon at the bottom of the OM Image Share display.
 - An **[Easy Setup]** tab will be displayed.
5. Follow the on-screen instructions in OM Image Share to scan the QR code and adjust connection settings.
 - If you are unable to scan the QR code, follow the on-screen instructions in OM Image Share to adjust settings manually.
 - **Bluetooth:** To connect, select the local name and enter the passcode displayed in the camera monitor into the **Bluetooth** settings dialog OM Image Share.
 - **Wi-Fi:** To connect, enter the SSID and password displayed on the camera monitor into the **Wi-Fi** settings dialog OM Image Share.
 -  1 will be displayed when pairing is complete.
 - The **Bluetooth**® icon indicates the status as follows:
 - : The camera is emitting wireless signal.
 - : Wireless connection has been established.

6. To end the Wi-Fi connection, press **MENU** on the camera or tap **[Disconnect]** on the monitor screen.
 - You can also turn the camera off and end the connection OM Image Share.
 - At default settings, **Bluetooth**[®] is kept active even after Wi-Fi connection is terminated, allowing you to shoot remotely with a smartphone. To set the camera to also terminate **Bluetooth**[®] connection when terminating Wi-Fi connection, set **[Bluetooth]** to **[Off]**.

Wireless Connection Standby Setting for When the Camera Is On

You can choose whether the camera will be on standby for wireless connection with a smartphone or optional remote control when the power is on.

1. Highlight **[Wi-Fi/Bluetooth Settings]** in the **Y** Setup Menu and press **▷**.

2. Highlight **[Bluetooth]** and press **▷**.

⑦ Pair the camera with the smartphone or optional remote control before proceeding.
[Bluetooth] cannot be selected unless the pairing has been completed.

3. Highlight the desired option and press the **OK** button.

Off	The camera will not be on standby for wireless connection and wireless signal will not be emitted even when the power is on. For connection with a smartphone, start [Device Connection] (P. 359) in the ▶ Playback Menu of the camera.
On [Ⓜ]	When the camera is on, it will emit wireless signal and be on standby for wireless connection. You can connect the camera and the smartphone through operation of OM Image Share and shoot remotely or transfer images.
On [Ⓜ] ⁱ	When the camera is turned on, it will start transmitting wireless signals and (if the devices have already been paired; P. 377) stand by for connection from a remote control.

- Because the options in the **[Bluetooth]** menu also serve to indicate **Bluetooth**[®] status, **[Stopped]** or **[Running]** will appear alongside the **[Off]**, **[On[Ⓜ]]**, and **[On[Ⓜ]ⁱ]** options.

📍 If the GPS track log is enabled in the dedicated OM Image Share app, location data downloaded from the app will be added to pictures taken while **[On[Ⓜ]]** is selected.

Wireless Settings for When the Camera Is Off

You can choose whether the camera will maintain a wireless connection to the smartphone when off.

1. Select **[Wi-Fi/Bluetooth Settings]** in the **Y** Setup Menu and press **▷**.
2. Highlight **[Power-off Standby]** and press **▷**.
3. Highlight the desired option and press the **OK** button.

Select	When you turn the camera off, you will be prompted to choose whether to maintain the wireless connection to the smartphone.
Off	Turning the camera off terminates the wireless connection to the smartphone.
On	When the camera is turned off, the connection to the smartphone remains active and the smartphone can still be used to download or view the pictures on the camera.

Select

When **[Select]** is chosen for **[Power-off Standby]**, a confirmation dialog will be displayed before the camera turns off if all the following conditions are met:

- **[On]** is selected for **[Wireless Functions]**,
- the camera and smartphone are paired (P. 359), and
- the memory card is correctly inserted.

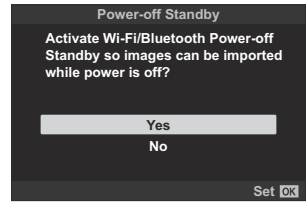

Yes	Turn the camera off but leave the wireless smartphone connection active.
No	Turn the camera off and terminate the wireless smartphone connection.

⚠ If no operations are performed about a minute after the confirmation dialog is displayed, the camera will end the wireless connection to the smartphone and turn off automatically.

⚠ If left active, the wireless connection will automatically terminate if:



- the connection remains inactive for 12 hours,
- the memory card is removed,
- the battery is replaced, or
- a charging error occurs during on-board battery charging.

The connection can be restored by turning the camera on.

🔊 Note that if **[On]** is selected for **[Power-off Standby]**, camera may not turn on immediately when the **ON/OFF** lever is rotated to **ON**.

Transferring images to a smartphone

You can select images in the camera and load them to a smartphone. You can also use the camera to select images you want to share in advance.  "Selecting Pictures for Sharing (Share Order)" (P. 190)

- If **[Off]** or **[On  is selected for **[Bluetooth]** (P. 361), select **[On .****
- Selecting **[On  for **[Bluetooth]** (P. 361) puts the camera on standby, ready for a wireless connection.**

1. Tap **[Import Photos]** in OM Image Share on the smartphone.

- ① Depending on the smartphone, a confirmation screen for Wi-Fi connection may appear. Follow the on-screen guidance to connect the smartphone and the camera.
- The images in the camera are displayed in a list.

2. Select the pictures you want to transfer and tap the Save button.

- When saving is completed, you can turn off the camera from the smartphone.
- **[Import Photos]** can be used to download pictures to smartphones connected via the **[Device Connection]** option in the camera menus even when **[Off]** or **[On  is selected for **[Bluetooth]** (P. 361).**

Automatically uploading images while the camera is off



To configure the camera to automatically upload images to a smartphone while off:

- mark pictures for sharing ([P. 190](#)),
- enable power-off standby ([P. 362](#)), and,
- if you are using an iOS device, launch the OM Image Share app in advance.

When you mark an image for sharing on the camera and turn the camera off, a notification appears in OM Image Share. When you tap the notification, images are automatically transferred to the smartphone.

Shooting remotely with a smartphone (Live View)

You can shoot remotely by operating the camera with a smartphone while checking the live view on the smartphone screen.

- The camera shows the connection screen and all operations are performed from the smartphone.
- If **[Off]** or **[On ** is selected for **[Bluetooth]** (P. 361), select **[On **.
- Selecting **[On ** for **[Bluetooth]** (P. 361) puts the camera on standby, ready for a wireless connection.

1. Launch OM Image Share and tap **[Remote Control]**.

2. Tap **[Live View]**.



3. Tap the shutter button to shoot.

- The image taken is saved on the memory card in the camera.

- **[Live View]** can be used to take pictures from smartphones connected via the **[Device Connection]** (P. 359) option in the camera menu even when **[Off]** or **[On ** is selected for **[Bluetooth]** (P. 361).
- Available shooting options are partially limited.

Shooting remotely with a smartphone (Remote Shutter)

You can shoot remotely by operating the camera with a smartphone (Remote Shutter).

- All operations are available on the camera. In addition, you can shoot pictures and record movies using the shutter button displayed on the smartphone screen.
- If **[Off]** or **[On ** is selected for **[Bluetooth]** (P. 361), select **[On **.
- Selecting **[On ** for **[Bluetooth]** (P. 361) puts the camera on standby, ready for a wireless connection.

1. Launch OM Image Share and tap **[Remote Control]**.

2. Tap **[Remote Shutter]**.

3. Tap the shutter button to shoot.





- The image taken is saved on the memory card in the camera.

- **[Remote Shutter]** can be used to take pictures from smartphones connected via the **[Device Connection]** (P. 359) option in the camera menu even when **[Off]** or **[On ** is selected for **[Bluetooth]** (P. 361).

Adding position information to images

Using the smartphone's GPS function, you can add position information when taking pictures with the camera.

- If **[Off]** or **[On]** is selected for **[Bluetooth]** (P. 361), select **[On]**.
- Selecting **[On]** for **[Bluetooth]** (P. 361) puts the camera on standby, ready for a wireless connection.

- 1.** Before taking pictures with the camera, launch OM Image Share and switch on the position information addition function.
 - When you are prompted to synchronize the clocks of the smartphone and the camera, follow the guides displayed in OM Image Share.
- 2.** Take pictures with the camera.
 - When it is possible to add position information,  will be lit on the shooting screen. When the camera cannot acquire position information,  blinks.
 - It may take some time before the camera is ready to add position information when it has been turned on or it has resumed from sleep mode.
 - Position information will be added to pictures taken while  is displayed on the screen.
 -  is displayed on the screen when you view a picture that has position information.
 - Position information is not added to movies.
- 3.** When you have finished shooting, switch off the position information addition function in OM Image Share.

Resetting wireless LAN/Bluetooth® settings

To restore **[Wi-Fi/Bluetooth Settings]** to default values:

1. Highlight **[Wi-Fi/Bluetooth Settings]** in the **Y** Setup Menu and press **▷**.
2. Highlight **[Reset Settings]** and press **▷**.
3. Highlight **[Yes]** and press the **OK** button.





 The following settings will be reset:

- **[Wireless Functions]** (P. 357), **[Bluetooth]** (P. 361), **[Connection Password]** (P. 370), and **[Power-off Standby]** (P. 362)

 Resetting wireless settings ends pairing between the camera and smartphones. Before connecting to a smartphone, you will need to pair the devices again (P. 359). Resetting wireless settings also ends pairing between the camera and remote controls. Before connecting to a remote control, you will need to pair the devices again (P. 377).

Changing the password

To change the password for smartphone connections:

1. Highlight **[Wi-Fi/Bluetooth Settings]** in the  Setup Menu and press .
2. Highlight **[Connection Password]** and press .
3. Press the  button as directed by the on-screen guide.
 - A new password will be set.

- You can change both password for smartphone connections and **Bluetooth®** connection passcode.
- Reconnect to the smartphone after changing passwords.  ["Pairing the Camera and Smartphone" \(P. 359\)](#)

Connecting the Camera to a Computer

Copying pictures to a computer

1. Turn the camera off and connect it to the computer.

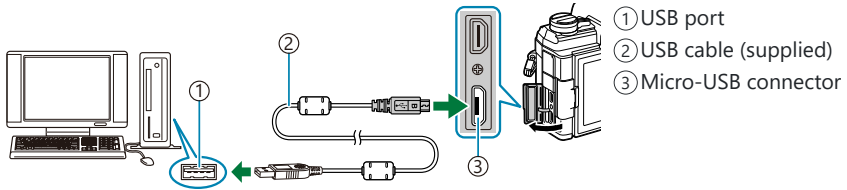

ⓘ The location of the USB port varies with the computer. For more information, refer to the documentation provided with your computer.

2. Turn the camera on.

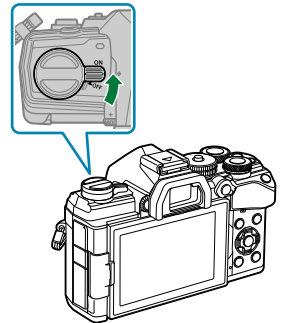

- The selection screen for the USB connection is displayed.
- ⓘ If USB connection options are not displayed, choose **[Select]** for **[USB Mode]** (P. 339) in the camera Custom Menus.
 - ⓘ If the camera display remains blank after the computer is connected, the battery may be exhausted. Use a fully-charged battery.

3. Highlight **[Storage]** or **[MTP]** using the Δ ∇ buttons. Press the **OK** button.

- **[Storage]**: The camera functions as a card reader.
- **[MTP]**: The camera functions as a portable device.

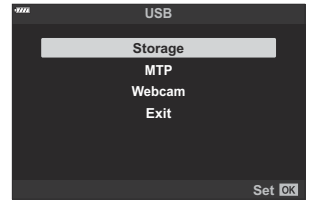

4. The camera will connect to the computer as a new storage device.

- ⓘ Data transfer is not guaranteed in the following environments, even if your computer is equipped with a USB port.
 - Computers with a USB port added by means of an extension card, etc., computers without a factory-installed OS, or home-built computers
- ⓘ Camera controls cannot be used while the camera is connected to a computer.
- ⓘ If the computer fails to detect the camera, disconnect and reconnect the USB cable.
- ⓘ Files over 4 GB in size cannot be copied to the computer when **[MTP]** is selected.

Installing the PC software

Install the following software to access the camera while it is connected directly to the computer via USB.

OM Workspace

This computer application is used to download and view photos and movies recorded with the camera. It can also be used to update the camera firmware. The software can be downloaded from our website. Be prepared to provide the camera serial number when downloading the software.



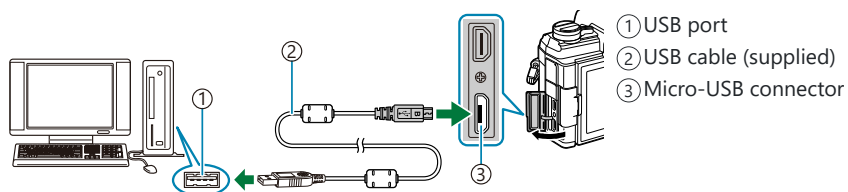

Using the Camera as a Webcam (Webcam)

The camera can be connected to a computer for use as a webcam for online meetings or live streaming. Video and audio are transmitted directly from the camera via a simple USB connection, obviating the need for special software or drivers (USB streaming).

1. After confirming that the camera is off, rotate the mode dial to .
2. Connect the camera to the computer.



 The location of the USB port varies with the computer. For more information, refer to the documentation provided with your computer.

3. Turn the camera on.
 -  If USB connection options are not displayed, choose **[Select]** for **[USB Mode]** (P. 339) in the camera Custom Menus.
 -  If the camera display remains blank after the computer is connected, the battery may be exhausted. Use a fully-charged battery.
4. Highlight **[Webcam]** using the Δ ∇ buttons and press the **OK** button.
 - The camera is now ready to start filming.
 - A ψ icon will appear in the display.
 - Adjust focus and exposure using camera controls.
5. Launch a web meeting or streaming app on the computer. Select the camera name in the app's device settings.
 - The camera will start transmitting audio and video.
 - Video is transmitted at a frame size of 1280 × 720 (**[HD]**).
 - The frame rate for video transmitted with **[60p]**, **[30p]**, or **[24p]** selected for **[  >** **[Frame Rate]** is **[30p]**, while the rate for video transmitted with **[50p]** or **[25p]** selected is **[25p]**.

📷 The camera can be used as a webcam even when no memory card is inserted.

📷 If an external microphone is connected, it will be used as the audio source.

⚠️ Video and audio will not be transmitted to the computer if:

- the mode dial is rotated to a position other than 📷, playback is in progress, or menus are displayed.

Using any of the above functions may temporarily disrupt audio and video in some web meeting or streaming apps.

⚠️ While the camera is supplying audio and video to the computer, you will not be able to:



- take photographs or record movies,
- change the options selected for [📷 🔍], or
- enable [📷 Specification Settings] > [📷 Picture Mode] in the 📷 Video Menu (P. 233) (selecting [On] will have no effect).

⚠️ Exposure and other camera settings cannot be adjusted from the computer.

Using the Remote Control

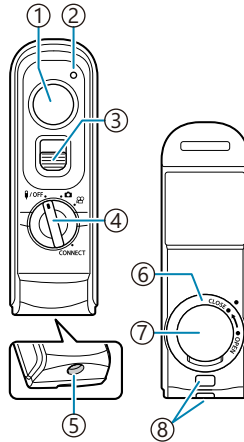
Names of parts



- ① Shutter button
- ② Data transfer indicator
- ③ Shutter button lock
- ④ Mode dial (OFF /  /  / CONNECT)
- ⑤ Cable connector
- ⑥ Battery-compartment lid
- ⑦ Battery compartment cover
- ⑧ Strap eyelet

Connection

Wired connection

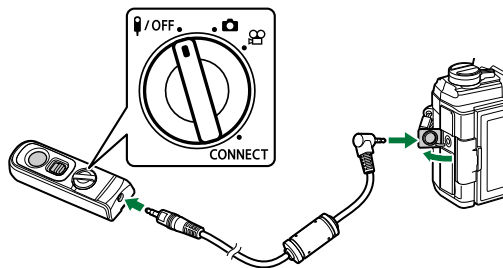

Rotate the mode dial of the remote control to **OFF** and connect the remote control to the camera via the supplied cable.

Photographs can be taken by pressing the shutter button.

Before recording movies, select **[REC]** for **[Shutter Function]**. [Video Menu > \[Button/Dial/Lever\] > \[Shutter Function\]](#) (P. 233)

ⓘ Wireless remote control is not available while the cable is connected.

🔒 To enable the shutter button for bulb photography or the like, slide the shutter button lock up.

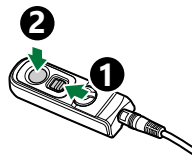

Wireless connection

For wireless connection, you must pair the camera and the remote control first.

1. Select **[Wi-Fi/Bluetooth Settings]** in the **Setup Menu** and press **▷**.
2. Highlight **[Wireless Shutter Setting]** and press **▷**.
3. Highlight **[Start Pairing]** and press the **OK** button.

4. When a message is displaying stating that pairing is in progress, rotate the mode dial on the remote control to **CONNECT** and keep it in this position.

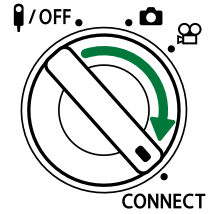
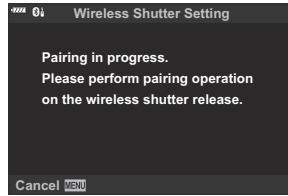

- Pairing starts when it is kept 3 seconds. Keep it in the **CONNECT** position until pairing is complete. If you rotate the mode dial before it is complete, the data transfer indicator flashes rapidly.
- The data transfer indicator lights when pairing starts.

5. When a message indicating pairing is complete is displayed, press the **OK** button.

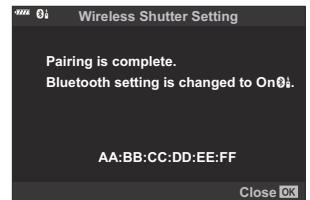



- The data transfer indicator goes out when pairing is complete.
 - **[Bluetooth]** (P. 361) will automatically be set to **[On]** when pairing is complete.
- ⓘ If you rotate the mode dial of the remote control or press the **MENU** button of the camera before the pairing completion message is displayed, the pairing process ends. Paired device information will be reset. Perform pairing again.
- ⓘ If you rotate the mode dial of a remote control that is not currently paired to **CONNECT** and keep it 3 seconds, or when pairing fails, the pairing information from previous connections will be reset. Perform pairing again.



Deleting pairing

1. Highlight **[Wi-Fi/Bluetooth Settings]** in the **⌵** Setup Menu and press **▷**.
2. Highlight **[Wireless Shutter Setting]** and press **▷**.
3. Select **[Delete Pairing]** and press the **OK** button.
4. Select **[Yes]** and press the **OK** button.

ⓘ When you have paired the camera with a remote control, you have to perform **[Delete Pairing]** to reset pairing information before you pair the camera with a new remote control.

Shooting from the remote control

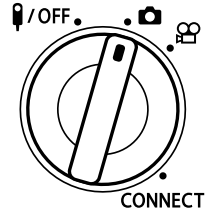

Before establishing a wireless connection between the camera and remote control, confirm that **[On **] is selected for **[Bluetooth]** (P. 361). When set to **[On **],  appears in the display and the camera will be on standby for wireless communication with the remote control as soon as it is turned on.

1. Rotate the mode dial of the remote control to  or .



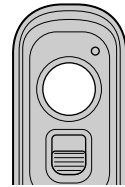



2. Press the shutter button on the remote control to take pictures.



- When the mode dial of the remote control is set to  (still photography mode): When you lightly press the shutter button of the remote control down to the first position (press the shutter button halfway), the AF confirmation mark (●) will be displayed, and a green frame (AF target) will be displayed in the focus location.
- When the mode dial of the remote control is set to  (movie recording mode): When you press the shutter button of the remote control, movie recording starts. Press the shutter button of the remote control again to stop movie recording.

Data transfer indicator of the remote control

Lights once	Remote control operation is sent to the camera correctly.
Flashes rapidly (1 second)	Remote control operation is not sent to the camera correctly. Shorten the distance between the camera and the remote control. If the problem is not solved, check the setting of the camera.
Flashes rapidly (3 seconds)	There is a problem regarding the pairing of the camera and remote control. Pair the devices again.
Does not light	This may occur in the following situations. <ul style="list-style-type: none">• The battery in the remote control is dead.• The mode dial of the remote control is in the /OFF position.• The camera and remote control are connected with a cable.

- ① You can connect to smartphones via [\[Device Connection\]](#) (P. 359) even when [\[On !\[\]\(c8dce68b26731c7aa5915072fc9d68dd_img.jpg\)\]](#) is selected for [\[Bluetooth\]](#) (P. 361). However, you cannot control the camera from the remote control when it is connected to a smartphone.
- ① Pairing and remote photography are not available when [\[Off\]](#) is selected for [\[Wireless Function\]](#) (P. 357).
- ① The camera does not enter sleep mode when a remote control is connected wirelessly.
- ① The camera will, however, enter sleep mode in accordance with the option selected for [\[Sleep\]](#) if the mode dial on the remote control is in the /OFF position.  [⚙ Custom Menu 12 > \[Sleep\]](#) (P. 296)
- ① The camera will not enter sleep mode when [\[On !\[\]\(7be5ea91065783fbb69e41ba5d9680f7_img.jpg\)\]](#) is selected for [\[Bluetooth\]](#) (P. 361) unless the mode dial on the remote control is in the /OFF position.
- ① If you operate the remote control while the camera is in sleep mode, it may take a longer time for the camera to resume operation.
- ① The camera cannot be controlled from the remote control while it is waking from sleep. Operate the remote control after the camera has resumed operation.
- ① Rotate the mode dial of the remote control to the /OFF position when you have finished using the remote control.

MAC address of the remote control

The MAC address of the remote control is printed on the warranty card provided with the remote control.

Precautions for using the remote control

- Do not tug on the battery compartment cover or use it to turn the battery-compartment lid.
- Do not pierce batteries with sharp objects.
- Do not drop or swing the remote control while holding the cable.
- Moisture on the cable or remote control connectors could interfere with wireless control and render wired connections unreliable.
- Confirm that the battery-compartment lid is free of foreign matter before closing it.
- Rotate the mode dial to **1/OFF** before connecting or disconnecting cables.

Connecting to TVs or External Displays via HDMI

Connecting the Camera to TVs or External Displays (HDMI)

Pictures can be displayed on televisions connected to the camera via HDMI. Use the television to display pictures to an audience. The TV remote can be used to control the display while the television is connected to the camera. No app or other software is required.

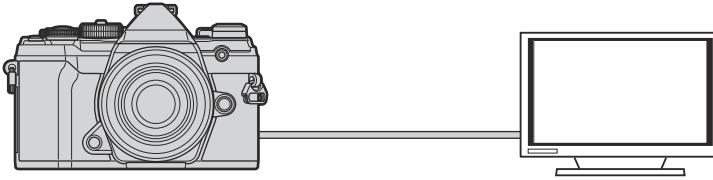

You can also film movies while the camera is connected to an external monitor or video recorder via HDMI.

ⓘ HDMI cables are available from third-party suppliers. Use an HDMI-certified cable.

Viewing Pictures on a TV (HDMI)

Photos and movies can be viewed on a high-definition TV connected directly to the camera by means of an HDMI cable. A remote control can be used to operate the display while it is connected to the camera.

HDMI Output

Choose the signal output to the HDMI device. You can adjust movie frame size and frame rate to match TV specifications and the video standards supported in your country or region. Match output settings to the input settings on the TV.

Output Size	The format for the video signal output via the HDMI connector can be chosen from the options below. [C4K] : 4K Digital Cinema (4096 × 2160) [4K] : 4K (3840 × 2160) priority [1080p] : Full High Definition (1080p) priority [720p] : High Definition (720p) priority [480p/576p] : 480p/576p
HDMI Control	The television remote control can be used to operate the camera in playback mode (P. 388). Choose from [Off] and [On] . When [On] is selected, the camera can be used for playback only.
Output Frame Rate	Choose a frame rate for the signal output via the HDMI connector according to whether the television supports NTSC (60p) or PAL (50p).

- **[HDMI Control]** and **[Output Frame Rate]** settings cannot be changed while the camera is connected to another device via HDMI.
- Audio can be output only on devices that support the audio format selected with the camera.
- The options available via **[HDMI Control]** vary with the device connected. See the device manual for details.

1. Press the **MENU** button to view the menus.

2. Display **⚙️** Custom Menu **D4** (Disp/⏻)/PC).

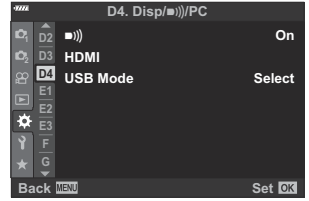

3. Highlight **[HDMI]** using the **△**/**▽** buttons and press the **▷** button.

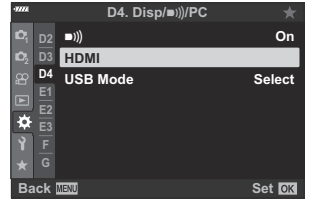

4. Highlight an item using the **△**/**▽** buttons and press the **▷** button.

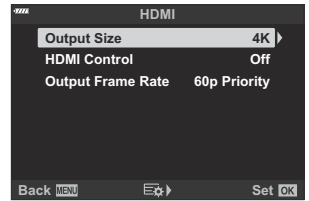

5. Highlight the desired option using the **△**/**▽** buttons and press the **OK** button.

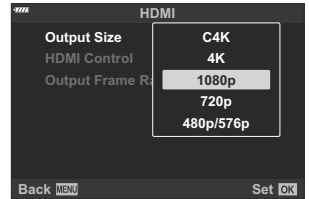

- Repeat Steps 4 and 5 as required.

6. Press the **MENU** button repeatedly to exit the menu.

Connecting the Camera to a TV



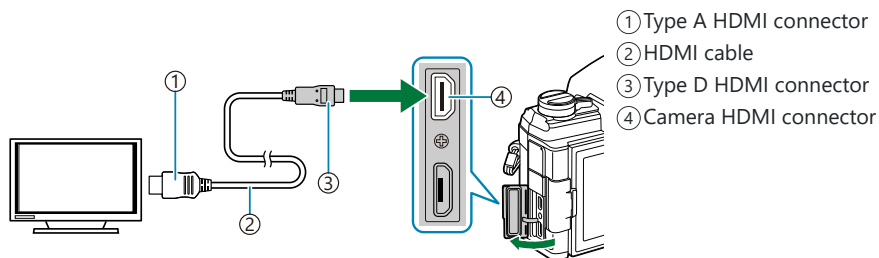

Connect the camera using an HDMI cable.

1. After confirming that the camera is off, connect it to the TV using an HDMI cable.



2. Switch the TV to HDMI input and turn the camera on.

- The TV will show the contents of the camera monitor. Press the  button to view pictures.

- If **[On]** is selected for **[HDMI Control]** (P. 388), the camera monitor will turn off when an HDMI cable is connected.
- For information on switching to HDMI input, see the manual provided with the TV.
- Depending on TV settings, the image may be cropped and some indicators may not be visible.
- HDMI cannot be used while the camera is connected to a computer via USB.
- If **[Record Mode]** is selected for  **[HDMI Output]** > **[Output Mode]** in the  **Video Menu** (P. 233), the signal will be output at the current movie frame size. No image will be displayed if the TV does not support the selected frame size. **[4K]** and **[C4K]** cannot be selected for  .
- The output format used when **[4K]** or **[C4K]** is selected in photo mode is 1080p priority.

Using a TV Remote (HDMI Control)

When connected to a TV via an HDMI cable, the camera can be operated using the television remote control.

- The television must support HDMI control. See the television manual for more information.

On	The television remote control can be used to operate the camera in playback mode. The camera can be used for playback only.
Off	The television remote control cannot be used to operate the camera. Indicators appear only in the TV display.

1. Press the **MENU** button to view the menus.
2. Highlight **[HDMI]** in **⚙ Custom Menu D4** and press the **▶** button.

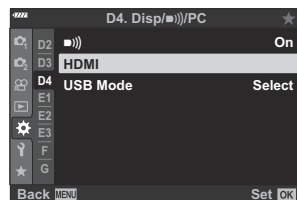

3. Highlight **[HDMI Control]** using the **△ ▽** buttons and press the **▶** button.

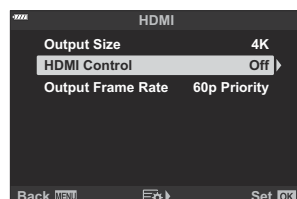

4. Highlight **[On]** using the **△ ▽** buttons and press the **OK** button.

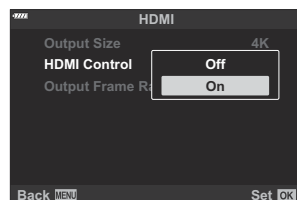

5. Press the **MENU** button repeatedly to exit the menus.

6. Connect the camera and TV via HDMI.

- Play pictures back using the TV remote. Follow the guide displayed on the TV screen.
- In single-frame playback, use the “red” button on the remote control to choose the information displayed and the “green” button to switch to the index display.

ⓘ Some functions may be unavailable on some televisions.

ⓘ The camera monitor turns off while the TV is used for playback.

Default Settings

Default Settings

Live Controls/LV Super Control Panel (P. 391)

 Shooting Menus (P. 396)

 Video Menu (P. 400)

 Playback Menu (P. 404)

 Setup Menu (P. 405)

 Custom Menus (P. 406)











Live Controls/LV Super Control Panel



*1: Can be added to **[Assign to Custom Mode]**.

*2: Default can be restored by selecting **[Full]** for **[Reset]**.













*3: Default can be restored by selecting **[Basic]** for **[Reset]**.





Shooting Mode: P, A, S, M, B

Item	Default	*1	*2	*3
ISO	Auto	✓	✓	✓
Flash Mode		✓	✓	✓
	±0	✓	✓	✓
Manual Value	 FULL (flash set to [MANUAL])	✓	✓	✓
 Image Stabilizer	S-IS AUTO	✓	✓	✓
 Image Stabilizer	M-IS 1	✓	✓	✓
WB	Auto ([On] selected for [WB AUTO Keep Warm Color])	✓	✓	✓
WB compensation A	±0	✓	✓	—
WB compensation G	±0	✓	✓	—
Kelvin	5400K ([CWB] selected for [WB])	✓	✓	—
AF Area	Center; single	✓	✓	✓
AF Mode	S-AF	✓	✓	✓
 Face Priority	Face Priority Off	✓	✓	—
		✓	✓	✓
Metering		✓	✓	✓
 	L F (High Res Shot: 50 F+RAW)	✓	✓	✓



Item	Default	*1	*2	*3
		✓	✓	✓
Picture Mode	Natural	✓	✓	✓
Sharpness	±0	✓	✓	—
Contrast	±0	✓	✓	—
Saturation	±0	✓	✓	—
Gradation	Gradation Normal	✓	✓	—
Effect	— ([i-Enhance] selected for [Picture Mode]: E Standard)	✓	✓	—
Color Filter	— ([Monochrome] selected for [Picture Mode]: N:None)	✓	✓	✓
Monochrome Color	— ([Monochrome] selected for [Picture Mode]: N:None)	✓	✓	✓
Aspect	4:3	✓	✓	✓
Color Space	sRGB	✓	✓	✓
Highlight&Shadow Control	<input checked="" type="checkbox"/> (±0)	✓	✓	✓
Movie 	On	✓	✓	✓

Shooting Mode: (Movie)

Item	Default	*1	*2	*3
ISO	[P] , [A] , or [S] selected for [ Mode] (movie exposure mode): Auto (fixed) [M] selected for [ Mode] (movie exposure mode): 200	—	✓	✓
Flash Mode	Flash Off (fixed)	—	—	—
	±0 (fixed)	—	—	—
 Image Stabilizer	S-IS Auto	✓	✓	✓
 Image Stabilizer	M-IS I	✓	✓	✓
WB	Auto ([On]) selected for [ AUTO Keep Warm Color]	—	✓	✓
WB compensation A	±0	—	✓	—
WB compensation G	±0	—	✓	—
Kelvin	5400K ([CWB]) selected for [WB]	—	✓	—
AF Area	Center; 9-target group	✓	✓	✓
AF Mode	C-AF	✓	✓	✓
 Face Priority	Face Priority Off	✓	✓	—
	 (fixed)	—	—	—
Metering	 (fixed)	—	—	—
 	I F	✓	✓	✓
 	K S 	✓	✓	✓
Picture Mode	Natural	✓	✓	✓

Item	Default	*1	*2	*3
Sharpness	±0	✓	✓	—
Contrast	±0	✓	✓	—
Saturation	±0	✓	✓	—
Gradation	Gradation Normal	✓	✓	—
Aspect	16:9 (fixed) C4K selected for [ ]: 17:9	—	—	—
Color Space	sRGB (fixed)	—	—	—
Highlight&Shadow Control	<input checked="" type="checkbox"/> (±0)	✓	✓	✓
 Mode	P	—	✓	—
Movie 	On	✓	✓	✓

Shooting Mode: RC

Item	Default	*1	*2	*3
 A group A	TTL	✓	✓	✓
 B group B	Off	✓	✓	✓
 C group C	Off	✓	✓	✓
 Camera Flash	Off	✓	✓	✓
Flash compensation	±0 (TTL, Auto)	✓	✓	✓
Flash level	1/1 (Manual)	✓	✓	✓
 /FP	 (Normal)	✓	✓	✓
 optical signal strength	Low	✓	✓	✓
Channel	1	✓	✓	✓



Shooting Menus

*1: Can be added to **[Assign to Custom Mode]**.

*2: Default can be restored by selecting **[Full]** for **[Reset]**.

*3: Default can be restored by selecting **[Basic]** for **[Reset]**.

Function		Default	*1	*2	*3
Reset / Custom Modes	Reset	Basic	—	✓	—
	Assign to Custom Mode	Shooting mode: P Image quality: L F+RAW	—	✓	—
	Custom Mode Save Settings	Reset	—	✓	—
	Recall from Custom Mode	—	—	✓	—
Picture Mode		Natural	✓	✓	✓
		L F (High Res Shot: 500 F+RAW)	✓	✓	✓
Image Aspect		4:3	✓	✓	✓
Digital Tele-converter		Off	✓	✓	✓
		<input type="checkbox"/>	✓	✓	✓

Function		Default	*1	*2	*3
Intrvl. Sh./Time Lapse		Off	—	✓	✓
	Number of Frames	99	—	✓	✓
	Start Waiting Time	00:00:01	—	✓	✓
	Interval Length	00:00:01	—	✓	✓
	Interval Mode	Time Priority	—	✓	✓
	Exposure Smoothing	On	—	✓	✓
	Time Lapse Movie	Off	—	✓	✓
Movie Settings	Movie Resolution	FullHD	—	✓	✓
	Frame Rate	10fps	—	✓	✓
High Res Shot	High Res Shot	 0 sec	✓	✓	—
	 Charge Time	0 sec	✓	✓	—
	Shooting Method	Handheld	✓	✓	—
Live ND Shooting		Off	✓	✓	✓
	ND Number	ND8(3EV)	✓	✓	—
	LV Simulation	On	✓	✓	—

Function		Default	*1	*2	*3
Bracketing		Off	✓	✓	✓
	AE BKT	3f 1.0 EV	✓	✓	✓
WB BKT	A–B	Off	✓	✓	✓
	G–M		✓	✓	✓
FL BKT		Off	✓	✓	✓
ISO BKT		Off	✓	✓	✓
ART BKT		Off	✓	✓	✓
Focus BKT		Off	✓	✓	✓
	Focus Stacking	Off	✓	✓	✓
	Set number of shots	[Off] selected for [Focus Stacking]: 99 [On] selected for [Focus Stacking]: 8	✓	✓	✓
	Set focus differential	5	✓	✓	✓
	⚡ Charge Time	0 sec	✓	✓	—
HDR		Off	✓	✓	✓
Multiple Exposure	Number of Frames	Off	—	✓	✓
	Auto Gain	Off	—	✓	✓
	Overlay	Off	—	✓	✓
Keystone Comp.		Off	✓	✓	✓

Function		Default	*1	*2	*3	
Anti-Shock [◆]/Silent [♥]	Anti-Shock [◆]	[◆] 0 sec	✓	✓	—	
	Silent [♥]	[♥] 0 sec	✓	✓	—	
	Noise Reduction [♥]	Off	✓	✓	—	
	Silent [♥] Mode Settings		—	✓	✓	—
		■))	Not Allow	✓	✓	—
		AF Illuminator	Not Allow	✓	✓	—
	Flash Mode	Not Allow	✓	✓	—	



















Video Menu

*1: Can be added to **[Assign to Custom Mode]**.









*2: Default can be restored by selecting **[Full]** for **[Reset]**.

*3: Default can be restored by selecting **[Basic]** for **[Reset]**.

Function		Default	*1	*2	*3	
Mode Settings	Mode	P	—	✓	—	
	Flicker Scan	Off	—	✓	✓	
Specification Settings	MOV 4K 30p	MOV 4K 30p	✓	✓	✓	
	M ISO-Auto Set	Upper Limit / Default	Upper Limit: 6400 Default: 200	✓	✓	✓
		M ISO-Auto	On	—	✓	—
	Noise Filter	Standard	✓	✓	✓	
	WB	Auto	—	✓	✓	
	All WB	A±0, G±0	—	✓	—	
	Keep Warm Color	On	—	✓	✓	
	Picture Mode	Off	✓	✓	—	
AF/IS Settings	AF Mode	C-AF	✓	✓	✓	
	C-AF Speed	±0	✓	✓	✓	
	C-AF Sensitivity	±0	✓	✓	✓	
	Image Stabilizer	M-IS ¹	✓	✓	✓	

Function			Default	*1	*2	*3
 Button/Dial/ Lever	 Button Function	 Off	Off	—	✓	—
		 View Selection	 View Selection	—	✓	—
		 Exposure 	Exposure 	—	✓	—
		 REC	 REC	—	✓	—
		 AEL/AFL	AEL/AFL	—	✓	—
		 ISO	ISO	—	✓	—
		 [ZOOM IN]	[ZOOM IN]	—	✓	—
		 [ZOOM OUT] (Electronic Zoom)	[ZOOM OUT] (Electronic Zoom)	—	✓	—
		 [WB]	[WB] (WB)	—	✓	—
		 Magnify	Magnify	—	✓	—
		 L-Fn	AF Stop	—	✓	—

Function		Default	*1	*2	*3	
Button/Dial/ Lever	Dial Function	P: Position 1	: :	—	✓	—
		P: Position 2	: VOL : VOL	—	✓	—
		A: Position 1	: : FNo.	—	✓	—
		A: Position 2	: VOL : VOL	—	✓	—
		S: Position 1	: : Shutter	—	✓	—
		S: Position 2	: VOL : VOL	—	✓	—
		M: Position 1	: FNo. : Shutter	—	✓	—
		M: Position 2	: VOL : ISO	—	✓	—
	Fn Lever Function		mode2	—	✓	—
		mode2	AF Mode/AF Target Mode/AF Target Point	—	✓	—
Shutter Function			—	✓	—	
Elec. Zoom Speed		Normal	—	✓	—	

Function		Default	*1	*2	*3	
Display Settings	 Control Settings	Live Control, Live SCP	—	✓	—	
	 Info Settings	Custom 1	—	✓	—	
	Red Frame during  REC	On	—	✓	—	
	Time Code Settings	Time Code Mode	Drop Frame	—	✓	—
		Count Up	Rec Run	—	✓	—
		Starting Time	0:00:00	—	✓	—
 View Assist	Off	—	✓	—		
Movie 		On	✓	✓	✓	
	Recording Volume	Built-in 	±0	—	✓	—
		MIC 	±0	—	✓	—
	 Volume Limiter	On	—	✓	—	
	Wind Noise Reduction	Off	—	✓	—	
	Recording Rate	48kHz/16bit	✓	✓	—	
	 Plug-in Power	Off	—	✓	—	
HDMI Output	Output Mode	Monitor Mode	—	✓	—	
	REC Bit	Off	✓	✓	—	
	Time Code	On	✓	✓	—	



Playback Menu

*1: Can be added to **[Assign to Custom Mode]**.

*2: Default can be restored by selecting **[Full]** for **[Reset]**.

*3: Default can be restored by selecting **[Basic]** for **[Reset]**.

Function		Default	*1	*2	*3
		On	✓	✓	✓
Edit	Sel. Image	RAW Data Edit	—	—	—
		JPEG Edit	—	—	—
		Movie Edit	—	—	—
			—	—	—
	Image Overlay		—	—	—
Print Order		—	—	—	—
Reset Protect		—	—	—	—
Reset share Order		—	—	—	—
Device Connection		—	—	—	—

Setup Menu

*1: Can be added to **[Assign to Custom Mode]**.

*2: Default can be restored by selecting **[Full]** for **[Reset]**.

*3: Default can be restored by selecting **[Basic]** for **[Reset]**.

Function		Default	*1	*2	*3
Card Setup		—	—	—	—
⏰ Settings	🕒	—	—	—	—
	Time Zone	—	—	—	—
🗣️		English	—	—	—
📶		🇯🇵 ±0, 🇺🇸 ±0, Natural	✓	✓	—
Image Review		Off	✓	✓	—
Wi-Fi/Bluetooth Settings	Wireless Functions	On	—	✓	—
	Bluetooth	Off	—	✓	—
	Wireless Shutter Setting	—	—	—	—
	Power-off Standby	Off	—	✓	—
	RAW+JPEG 🔄	JPEG	—	✓	—
	Connection Password	—	—	—	—
	Reset Settings	—	—	—	—
Firmware Version		—	—	—	—











Custom Menus

*1: Can be added to **[Assign to Custom Mode]**.



*2: Default can be restored by selecting **[Full]** for **[Reset]**.





*3: Default can be restored by selecting **[Basic]** for **[Reset]**.

A1 AF/MF

Function		Default	*1	*2	*3
	AF Mode	S-AF	✓	✓	✓
	AF+ MF	Off	✓	✓	✓
	AEL/AFL				
	S-AF	mode3	✓	✓	✓
	C-AF	mode4	✓	✓	✓
	MF	mode3	✓	✓	✓
	 AF	mode3	✓	✓	✓
	Half Way AF	Operative	✓	✓	✓
	Face Priority AF	 : On  : On	✓	✓	✓
	AF Scanner	mode2	✓	✓	✓
	C-AF Sensitivity	±0	✓	✓	✓
	C-AF Center Start	 (All Targets)	✓	✓	✓
	C-AF Center Priority	5, 9, or 25 targets	✓	✓	✓

A2 AF/MF

Function		Default	*1	*2	*3
	 Mode Settings	All; Small; 5-, 9-, or 25-target group	✓	✓	✓

Function		Default	*1	*2	*3
AF Area Pointer		On1	✓	✓	✓
[⋮] Set Home		AF Target Mode ([ALL]), AF Target Point	—	✓	✓
[⋮] Select Screen Settings		Set 1	✓	✓	✓
		[⋮]Mode	✓	✓	✓
		[⋮]Mode	✓	✓	✓
		⊞ Pos	✓	✓	✓
		⊞ Pos	✓	✓	✓
[⋮] Loop Settings	[⋮] Loop Selection	Off	✓	✓	✓
	Via [ALL]	No	✓	✓	✓
[⋮] Target Mode Settings		1×1; vertical and horizontal step size: 1	✓	✓	—
 Orientation Linked [⋮]		Off	✓	✓	—

A3 AF/MF

Function		Default	*1	*2	*3
AF Targeting Pad		Off	✓	✓	✓
AF Limiter		Off	✓	✓	✓
	Distance settings	Setting 1	✓	✓	✓
	Release Priority	On	✓	✓	✓
AF Illuminator		On	✓	✓	✓
 Face Priority		Off	✓	✓	—





















Function	Default	*1	*2	*3
AF Focus Adj. ¹	Off	✓	✓	✓































1 Using **[Reset]** to perform a full or standard reset does not affect saved values.



A4 AF/MF

Function	Default	*1	*2	*3
Starry Sky AF Setting	Speed	✓	✓	✓
Preset MF distance	999.9 m	✓	✓	✓
MF Assist	Magnify	✓	✓	—
	Peaking	✓	✓	—
	Focus Indicator	✓	✓	—
MF Clutch	Operative	✓	✓	✓
Focus Ring	↻	✓	✓	✓
Bulb/Time Focusing	On	✓	✓	✓
Reset Lens	Off	✓	✓	✓





B Button/Dial



Function		Default	*1	*2	*3
 Button Function		Sequential shooting/self-timer	✓	✓	—
		 View Selection	✓	✓	—
		Exposure 	✓	✓	—
		 REC	✓	✓	—
		AEL/AFL	✓	✓	—
		ISO	✓	✓	—
			✓	✓	—
		 (Flash Mode)	✓	✓	—
		 ( / )	✓	✓	—
		Preview	✓	✓	—
		AF Stop	✓	✓	—

Function			Default	*1	*2	*3
 Dial Function	P	Position 1	 :   : Ps	✓	✓	—
		Position 2	 : ISO  : WB	✓	✓	—
	A	Position 1	 :   : FNo.	✓	✓	—
		Position 2	 : ISO  : WB	✓	✓	—
	S	Position 1	 :   : Shutter	✓	✓	—
		Position 2	 : ISO  : WB	✓	✓	—
	M/B	Position 1	 : FNo.  : Shutter	✓	✓	—
		Position 2	 :   : ISO	✓	✓	—
	Menu		 :   :  /Value	—	✓	—
			 : Prev/Next  :  	—	✓	—
Dial Direction	Exposure	Dial1	✓	✓	—	
	Ps	Dial1	✓	✓	—	
 Fn Lever Function			mode2	—	✓	—
mode2		AF Mode/AF Target Mode/AF Target Point	—	✓	—	
Fn Lever/Power Lever			Fn	—	✓	—



Function	Default	*1	*2	*3
 Elec. Zoom Speed	Normal	✓	✓	—
  Function	<input checked="" type="checkbox"/>	—	✓	—

Release//Image Stabilizer









Function	Default	*1	*2	*3		
S-AF Release Priority	Off	✓	✓	✓		
C-AF Release Priority	On	✓	✓	✓		
 L Settings		Max fps	6 fps	✓	✓	✓
		Frame Count Limiter	Off	✓	✓	✓
		Max fps	10 fps	✓	✓	✓
		Frame Count Limiter	Off	✓	✓	✓
		Pre-shutter Frames	8 shots	✓	✓	✓
		Frame Count Limiter	25 shots	✓	✓	✓

Function			Default	*1	*2	*3
 H Settings		Max fps	10 fps	✓	✓	✓
		Frame Count Limiter	Off	✓	✓	✓
		Max fps	30 fps	✓	✓	✓
		Frame Count Limiter	Off	✓	✓	✓
	Pro Cap	Max fps	30 fps	✓	✓	✓
		Pre-shutter Frames	12 shots	✓	✓	✓
		Frame Count Limiter	25 shots	✓	✓	✓
	Flicker Reduction	Anti-Flicker LV	Auto	✓	✓	—
		Anti-Flicker Shooting	Off	✓	✓	—

Release//Image Stabilizer

Function			Default	*1	*2	*3
	Image Stabilizer		S-IS AUTO	✓	✓	✓
	Image Stabilizer		Fps Priority	✓	✓	—
	Half Way Rls With IS		On	—	✓	—
	Lens I.S. Priority		Off	✓	✓	✓

D1 Disp/PC

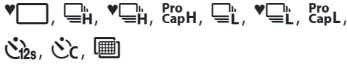
Function		Default	*1	*2	*3
 Control Settings		Live Guide	—	✓	—
	P/A/S/M/B	Live SCP	✓	✓	—
	ART	Art Menu	—	✓	—
	SCN	Scene Menu	—	✓	—
 /Info Settings	 Info	Image Only, Overall	✓	✓	✓
	 Info	Magnify Frame, Magnify Scroll, Select Frame	—	✓	—
	LV-Info	Image Only, Custom 1, Custom 2	✓	✓	—
	 Informations during half way	On	✓	✓	—
	LV OFF-Info	Shooting Information	✓	✓	—
	 Settings	25, Calendar	✓	✓	—
Picture Mode Settings		All On	✓	✓	—
 /  Settings			✓	✓	—
Multi Function Settings		All on except WB and ISO	✓	✓	—

D2 Disp/⏏)/PC

Function		Default	*1	*2	*3
Live View Boost	Manual Shooting	Off	✓	✓	✓
	Bulb/Time	On 2, Frame Rate Priority	✓	✓	✓
	Live Composite	Off	✓	✓	✓
	Others	Off	✓	✓	✓
Art LV Mode		mode1	✓	✓	—
LV Close Up Settings	LV Close Up Mode	mode2	✓	✓	—
	Live View Boost	Off	✓	✓	—
🎥🔍 Default Setting		Recently	—	✓	—
⚙️ Settings	🔒 Lock	Off	✓	✓	—
	Live View Boost	Off	✓	✓	—

D3 Disp/⏏)/PC

Function		Default	*1	*2	*3
Grid Settings	Display Color	Preset 1	✓	✓	—
	Displayed Grid	Off	✓	✓	—
	Apply Settings to EVF	On	✓	✓	—
Peaking Settings	Peaking Color	Red	✓	✓	—
	Highlight Intensity	Normal	✓	✓	—
	Image Brightness Adj.	Off	✓	✓	—

Function		Default	*1	*2	*3
Histogram Settings	Highlight	255	✓	✓	—
	Shadow	0	✓	✓	—
Mode Guide		Off	✓	✓	—
Selfie Assist		On	—	✓	—

D4 Disp/■)))/PC

Function		Default	*1	*2	*3
■))		On	✓	✓	✓
HDMI	Output Size	4K	—	✓	—
	HDMI Control	Off	—	✓	—
	Output Frame Rate	60p Priority	—	—	—
USB Mode		Select	—	✓	✓

E1 Exp/ISO/BULB/📷





Function		Default	*1	*2	*3
EV Step		1/3 EV	✓	✓	✓
ISO Step		1/3 EV	✓	✓	✓
📷 ISO-Auto Set	Upper Limit / Default	Upper Limit: 6400 Default: 200	✓	✓	✓
	Lowest S/S Setting	Auto	✓	✓	—
📷 ISO-Auto		P/A/S/M	✓	✓	—
📷 Noise Filter		Normal	✓	✓	✓

Function	Default	*1	*2	*3
 Low ISO Processing	Drive Priority	✓	✓	✓
Noise Reduct.	Auto	✓	✓	✓

E2 Exp/ISO/BULB/

Function	Default	*1	*2	*3
Bulb/Time Timer	8 min	✓	✓	✓
Live Composite Timer	3h	✓	✓	✓
Bulb/Time Monitor	-7	✓	✓	—
Live Bulb	Off	✓	✓	—
Live Time	0.5 sec	✓	✓	—
Composite Settings	1 sec	✓	✓	—
 Flicker Scan	Off	✓	✓	✓

E3 Exp/ISO/BULB/

Function	Default	*1	*2	*3	
Metering		✓	✓	✓	
AEL Metering	Auto	✓	✓	✓	
 Spot Metering	Spot, Spot Hilight, Spot Shadow	✓	✓	✓	
Exposure Shift		±0	✓	✓	—
		±0	✓	✓	—
		±0	✓	✓	—

F ⚡ Custom

Function	Default	*1	*2	*3
⚡ X-Sync.	1/250	✓	✓	✓
⚡ Slow Limit	Off	✓	✓	✓
⚡ +	Off	✓	✓	✓
⚡ +WB	Off	✓	✓	—
⚡ RC Mode	Off	✓	✓	✓

G /WB/Color

Function	Default	*1	*2	*3	
Set	1: L SF 2: L F 3: L N 4: M N	✓	✓	✓	
Pixel Count	M iddle	3200×2400	✓	✓	✓
	S mall	1280×960	✓	✓	✓
Shading Comp.	Off	✓	✓	✓	
WB	Auto	✓	✓	✓	
All	A±0, G±0	✓	✓	—	
AUTO Keep Warm Color	On	✓	✓	✓	
Color Space	sRGB	✓	✓	✓	

H1 Record/Erase

Function		Default	*1	*2	*3
File Name		Reset	✓	✓	—
Edit Filename		Off	✓	✓	—
dpi Settings		350 dpi	✓	✓	—
Copyright Settings ¹	Copyright Info.	Off	✓	✓	—
	Artist Name	—	—	—	—
	Copyright Name	—	—	—	—
Lens Info Settings ¹		Off	—	✓	—



1 Using **[Reset]** to perform a full or standard reset does not affect saved values.

H2 Record/Erase

Function		Default	*1	*2	*3
Quick Erase		Off	✓	✓	✓
RAW+JPEG Erase		RAW+JPEG	✓	✓	✓
Priority Set		No	✓	✓	✓















I EVF

Function		Default	*1	*2	*3
EVF Auto Switch		On2	—	✓	—
EVF Adjust	EVF Auto Luminance	Off	✓	✓	—
	EVF Adjust	ⓘ ±0, ⚙ ±0	✓	✓	—

Function		Default	*1	*2	*3
EVF Style		Style 3	—	✓	—
 Info Settings		Basic Information, Custom1, Custom2	✓	✓	—
EVF Grid Settings	Display Color	Preset 1	✓	✓	—
	Displayed Grid	Off	✓	✓	—
 Half Way Level		On	✓	✓	—
S-OVF		Off	✓	✓	✓

Utility

Function		Default	*1	*2	*3
Pixel Mapping		—	—	—	—

Function		Default	*1	*2	*3
Press-and-hold Time	End LV 	0.7 sec	✓	✓	—
	Reset LV  Frame	0.7 sec	✓	✓	—
	End 	0.7 sec	✓	✓	—
	Reset  Frame	0.7 sec	✓	✓	—
	Reset 	0.7 sec	✓	✓	—
	Reset 	0.7 sec	✓	✓	—
	Reset 	0.7 sec	✓	✓	—
	Reset 	0.7 sec	✓	✓	—
	Reset 	0.7 sec	✓	✓	—
	Call EVF Auto Switch	0.7 sec	✓	✓	—
	End  	0.7 sec	✓	✓	—
	End 	0.7 sec	✓	✓	—
	Reset 	0.7 sec	✓	✓	—
	Switch  Lock	0.7 sec	✓	✓	—
	Call BKT Settings	0.7 sec	✓	✓	—
	End Flicker Scan	0.7 sec	✓	✓	—
Level Adjust	—	—	✓	—	
Touchscreen Settings	On	—	✓	—	
Menu Recall	Recall	✓	✓	—	
Fisheye Compensation	Off	✓	✓	—	

J2 Utility

Function		Default	*1	*2	*3
Backlit LCD		Hold	✓	✓	✓
Sleep		1 min	✓	✓	✓
Auto Power Off		4h	✓	✓	✓
Quick Sleep Mode		Off	✓	✓	✓
	Backlit LCD	8 sec	✓	✓	—
	Sleep	10 sec	✓	✓	—
Certification		—	—	—	—

Memory Card Capacity

Memory Card Capacity: Photos

Figures are for a 64 GB SDXC card used to record photos with an aspect ratio of 4:3.

Record mode	Image size (Pixel Count)	Compression ratio	File format	File size (MB) (approx.)	Number of storable still pictures
50m F+RAW	(Tripod) 10368×7776	Lossless compression	ORF	(Tripod) 168.2 (Handheld) 117.1	(Tripod) 355 (Handheld) 489
	(Handheld) 8160×6120				
	8160×6120	1/4	JPEG		
	5184×3888	Lossless compression	ORI		
25m F+RAW	(Tripod) 10368×7776	Lossless compression	ORF	(Tripod) 157.4 (Handheld) 106.3	(Tripod) 359 (Handheld) 542
	(Handheld) 8160×6120				
	5760×4320	1/4	JPEG		
	5184×3888	Lossless compression	ORI		
50m F	8160×6120	1/4	JPEG	21.7	2529
25m F	5760×4320	1/4	JPEG	10.9	5033

Record mode	Image size (Pixel Count)	Compression ratio	File format	File size (MB) (approx.)	Number of storable still pictures
RAW	5184 × 3888	Lossless compression	ORF	21.5	2838
L SF		1/2.7	JPEG	13.1	4209
L F		1/4		8.9	6180
L N		1/8		4.6	11909
M SF	3200 × 2400	1/2.7		5.1	10614
M F		1/4		3.6	15258
M N		1/8		1.9	28721
M SF	1920 × 1440	1/2.7		2.0	27126
M F		1/4		1.4	37559
M N		1/8		0.9	61033
S SF	1280 × 960	1/2.7		1.0	54252
S SF		1/4		0.8	69752
S N		1/8		0.5	97654
S SF	1024 × 768	1/2.7	0.8	69752	
S SF		1/4	0.6	97654	
S N		1/8	0.3	244135	

- The number of storable still pictures may change according to the subject, whether or not print reservations have been made, and other factors. In certain instances, the number of storable still pictures displayed on the monitor will not change even when you take pictures or erase stored images.
- The actual file size varies according to the subject.
- The maximum number of storable still pictures displayed on the monitor is 9999.

Memory Card Capacity: Movies

Figures are for a 64 GB SDXC memory card.

Frame size	Compression	Frame rate	Capacity (approx.)
C4K	—	24p	33 minutes
4K	—	30p, 25p, 24p	1 hour 18 minutes
FHD	A-I	30p, 25p, 24p	39 minutes
	SF	60p, 50p, 30p, 25p, 24p	2 hours 35 minutes
	F		4 hours 31 minutes
	N		7 hours 37 minutes
HD	A-I	60p, 50p, 30p, 25p, 24p	1 hour 18 minutes
	SF		5 hours 13 minutes
	F		9 hours 52 minutes
	N		13 hours 59 minutes

- Figures are for footage recorded at the maximum frame rate. The actual bit rate varies with the frame rate and scene recorded.
- When an SDXC card is used, movies over 2 hours are recorded over multiple files (depending on shooting conditions, the camera may start recording to a new file before the 2-hour limit is reached).
- When an SD/SDHC card is used, movies over 4 GB in size are recorded over multiple files (depending on shooting conditions, the camera may start recording to a new file before the 4 GB limit is reached).

Cautions

Information about Dust and Water Resistant Features

- This camera has a water resistant specification of IPX3 (when used in combination with an IPX3 or higher water resistant lens supplied by our company).
- This camera has a dust resistant specification of IP5X (under our company's test conditions).

Precautions

- Dust and water resistant capabilities may be lost when the camera is subjected to shock.
- Examine the following components for the presence of dirt, dust, sand, or other foreign matter: the seals and surfaces of all covers, including those for the connectors and the battery and card compartments, the mounting surfaces on the camera and lens, and all connectors for accessories and the like. Remove any foreign matter with a clean, lint-free cloth.
- To ensure dust and water resistant capabilities, close the covers firmly and attach the lens before use.
- Do not operate the camera, open/close the covers, or attach/remove the lens when they are wet.
- Water resistant feature is ensured only when compatible lenses/accessories are attached. Check the compatibility.
For compatible accessories, visit our website.

Maintenance

- Wipe off water thoroughly with a dry cloth.
- Remove foreign materials such as dirt, dust or sand thoroughly.

Batteries

- The camera uses our lithium-ion battery. Never use any battery other than our genuine batteries.
- The camera's power consumption varies widely with usage and other conditions.
- As the following consume a lot of power even without shooting, the battery will be drained quickly.
 - Performing auto focus repeatedly by pressing the shutter button halfway in shooting mode.
 - Displaying images on the monitor for a prolonged period.
 - When connected to a computer.
 - Leaving wireless LAN/**Bluetooth**® enabled.
- When using a drained battery, the camera may turn off without the low battery warning being displayed.
- Remove the batteries before putting the camera into storage for periods of a month or more. Leaving the batteries in the camera for extended periods shortens their lives, potentially rendering them unusable.
- The normal charging time using the provided USB-AC adapter is approximately 4 hours (estimated).
- Do not use USB-AC adapters or chargers not specifically designated for use with batteries of the supplied type. Similarly, do not use the supplied USB-AC adapter with batteries (cameras) other than those of the designated type.
- There is a risk of explosion if the battery is replaced with the incorrect battery type.
- Dispose of the used battery following the instructions "[⚠ CAUTION](#)" (P. 462) in the instruction manual.

Using your USB-AC adapter abroad

- The USB-AC adapter can be used in most home electrical sources within the range of 100 V to 240 V AC (50/60 Hz) around the world. However, depending on the country or area you are in, the AC wall outlet may be shaped differently and the USB-AC adapter may require a plug adapter to match the wall outlet.
- Do not use third-party travel adapters as the USB-AC adapter may malfunction.

Information

Interchangeable lenses

Choose a lens according to the scene and your creative intent. Use lenses designed exclusively for the Micro Four Thirds system and bearing the M.ZUIKO DIGITAL label or the symbol shown here.



With an adapter, you can also use Four Thirds System lenses. The optional adapter is required.

- When you attach or remove the body cap and lens from the camera, keep the lens mount on the camera pointed downward. This helps prevent dust and other foreign matter from getting inside the camera.
- Do not remove the body cap or attach the lens in dusty places.
- Do not point the lens attached to the camera toward the sun. This may cause the camera to malfunction or even ignite due to the magnifying effect of sunlight focusing through the lens.
- Be careful not to lose the body cap and rear cap.
- Attach the body cap to the camera to prevent dust from getting inside when no lens is attached.

Lens and camera combinations

Lens	Camera	Attachment	AF	Metering
Micro Four Thirds system lens	Micro Four Thirds system camera	Yes	Yes	Yes
Four Thirds system lens		Attachment possible with mount adapter	Yes ¹	Yes

¹ Not available during movie recording or with starry sky AF.

MF Clutch Lenses

The “MF clutch” (manual focus clutch) mechanism on MF clutch lenses can be used to switch between auto and manual focus simply by repositioning the focus ring.

- Check the position of the MF clutch before shooting.
- Sliding the focus ring to the AF/MF position at the end of the lens selects autofocus, while sliding it to the MF position closer to the camera body selects manual focus, regardless of the focus mode chosen with the camera.

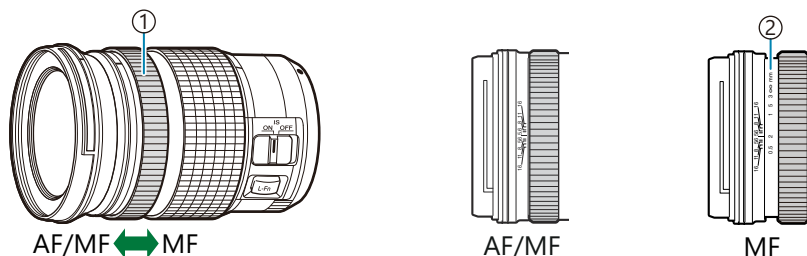

- ① Focus ring
- ② Focus distances visible

- ⚠ Selecting **[Inoperative]** for **[MF Clutch]** in **⚙ Custom Menu A4** (P. 273) disables manual focus even when the MF clutch is in the MF position.

Camera Displays for Lens SET and CALL Functions

The camera displays “SET ●” when the focus position is saved using the SET option and “CALL ●” when a saved focus position is restored using the CALL option. For more information on SET and CALL, see the lens manual.



Optional Accessories

Grip (ECG-5)

The grip helps you keep the camera steady when using large lenses. Make sure to turn the camera off when attaching and removing the grip.

Part names

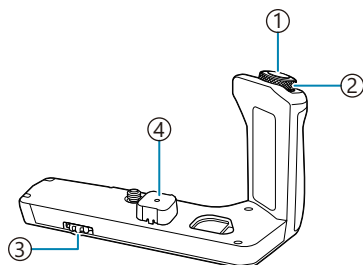

- ① Shutter button
- ② Front dial
- ③ Removal knob
- ④ Connector cap

Attaching the Grip

Before attaching the grip, remove the connector cover (a) from the bottom of the camera and the connector cap (b) from the ECG-5. Once attached, make sure the ECG-5 removal knob is tightly secured. Be sure to attach the connector cover to the camera and the connector cap to the ECG-5 when the ECG-5 is not in use.

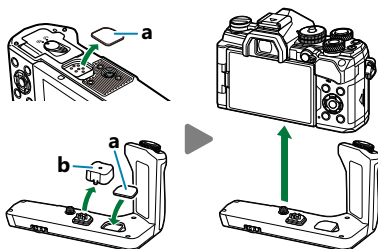

Store the connector cover (a) in the ECG-5

Main Specifications (ECG-5)

Dimensions	Approx. 128.4 mm (W) × 76 mm (H) × 60.2 mm (D) (5.1" × 3.0" × 2.4") (excluding protrusions)
Weight	Approx. 121 g (4.3 oz.) (excluding terminal cap)
Splash resistance (when attached to camera)	Type: Equivalent to IEC Standard publication 60529 IPX1

Precautions

- Do not use your nail to turn the removal knob. Doing so could result in injury.
- Only use the camera within the guaranteed operating temperature range.
- Do not use or store the product in dusty or humid areas.
- Do not touch the electrical contacts.
- Clean the grip and connector using a soft, dry cloth. Do not use damp cloths or organic solvents such as thinner or benzine.

Designated External Flash Units

When using an optional flash unit designed for use with the camera, you can choose the flash mode using camera controls and take pictures with the flash. See the documentation provided with the flash unit for information on flash features and their use.

Choose a flash unit to suit your needs, taking into consideration such factors as the output required and whether the unit supports macro photography. Flash units designed to communicate with the camera support a variety of flash modes, including TTL auto and super FP. Flash units can be mounted on the camera hot shoe or connected using a cable (available separately) and flash bracket. The camera also supports the following wireless flash control systems:

Radio-Controlled Flash Photography: CMD, ⚡CMD, RCV, and X-RCV Modes

The camera controls one or more remote flash units by means of radio signals. The range of locations in which flash units can be placed increases. Flash units can control other compatible units or be fitted with radio commander/receivers to allow the use of units that do not otherwise support radio flash control.

Wireless Remote-Control Flash Photography: RC Mode

The camera controls one or more remote flash units by means of optical signals. The flash mode can be selected using camera controls ([P. 149](#)).

Features Available with Compatible Flash Units

FL-700WR

Supported flash control modes	TTL-AUTO, MANUAL, FP TTL AUTO, FP MANUAL, MULTI, RC, SL MANUAL
GN (Guide Number, ISO 100)	GN 42 (75/150 mm ¹) GN 21 (12/24 mm ¹)
Supported wireless systems	CMD, ⚡CMD, RCV, X-RCV, RC

FL-900R

Supported flash control modes	TTL-AUTO, AUTO, MANUAL, FP TTL AUTO, FP MANUAL, MULTI, RC, SL AUTO, SL MANUAL
GN (Guide Number, ISO 100)	GN 58 (100/200 mm ¹) GN 27 (12/24 mm ¹)
Supported wireless systems	RC

STF-8

Supported flash control modes	TTL-AUTO, MANUAL, RC ²
GN (Guide Number, ISO 100)	GN 8.5
Supported wireless systems	RC ²

FL-LM3

Supported flash control modes	Varies with camera settings.
GN (Guide Number, ISO 100)	GN 9.1 (12/24 mm ¹)

- 1 Maximum lens focal length at which unit can provide flash coverage (figures following slashes are 35 mm format equivalent focal lengths).
- 2 Functions as commander (transmitter) only.

Wireless remote control flash photography

Wireless flash photography is available with compatible flash units that support wireless remote control (RC). The remote flash units are controlled via a unit mounted on the camera hot shoe. Settings can be adjusted separately for the camera-mounted unit and units in up to three other groups.

RC mode must be enabled on both the master and remote flash units (P. 432).

Enabling RC Mode

1. Set the remote flash units to RC mode and place them as desired.
 - Turn the external flash units on, press the **MODE** button, and select RC mode.
 - Select a channel and group for each external flash unit.
2. Select **[On]** for **[⚡ RC Mode]** in **⚙ Custom Menu F** (P. 287) and press the **OK** button.
 - The camera will exit to the shooting display.
 - A **RC** icon will be displayed.



3. Press the **OK** button.

- The RC mode super control panel will be displayed.

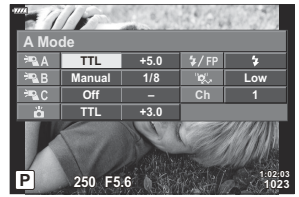

- The standard LV super control panel can be displayed by pressing the **INFO** button. The display will change each time the **INFO** button is pressed.

4. Adjust flash settings.

- Highlight items using the Δ ∇ \triangleleft \triangleright buttons and rotate the front dial to choose settings.

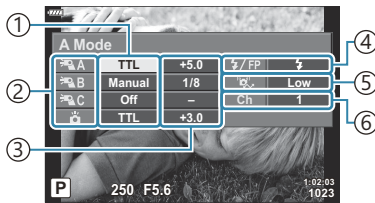

- ① Supported flash control modes
- ② Group
- ③ Flash compensation
- ④ Flash mode
- ⑤ Optical signal strength
- ⑥ Channel

Group	Choose a group. Changes to settings apply to all units in the selected group. Choose to adjust settings for the unit mounted on the camera.
Supported flash control modes	Choose a flash mode.
Flash compensation	Adjust flash output. When MANUAL is selected for flash mode, you can choose a value for manual flash output.
Optical signal strength	Choose the brightness of the optical control signals emitted by the flash units. Choose [HI] if you have placed flash units at close to the maximum distance from the camera. This setting applies to all groups.
Flash mode/ flash level	Choose (standard) or FP (super FP). Choose super FP for shutter speeds faster than the flash sync speed. This setting applies to all groups.
Channel	Choose the channel used for flash control. Change the channel if you find that other light sources in the area are interfering with remote flash control.

5. Set the unit mounted on the camera to **[TTL AUTO]**.
 - Flash control settings for the FL-LM3 can only be adjusted using the camera.

Positioning Remote Flash Units

1. Set the wireless RC flash units to RC mode.
 - After turning compatible flash units on, press the **MODE** button and choose RC mode.
 - Choose a group for each of the compatible flash units using flash controls and match the channel to that selected with the camera.
2. Position the flash units.
 - Position the wireless units with the remote sensors facing the camera.
3. Take pictures after confirming that the remote units and the unit on the camera are charged.

Wireless Flash Control Range

The illustration is intended as a guide only. The flash control range varies with the type of flash mounted on the camera and the conditions in the surrounding area.

Flash Control Range for Camera-Mounted FL-LM3 Flash Units

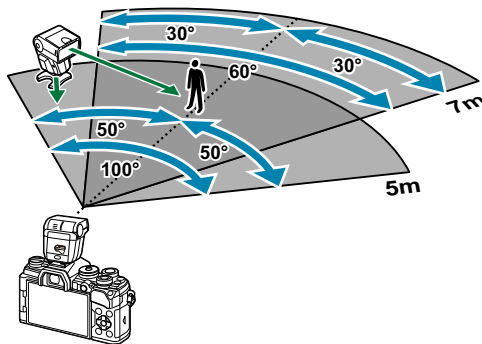

- We recommend that each group contain no more than 3 flash units.
- Wireless flash photography is not available in anti-shock mode or in rear-curtain slow sync mode when a shutter speed slower than 4 s is selected.
- Start wait times longer than 4 s cannot be selected in anti-shock and silent modes.

- Flash control signals may interfere with exposure if the subject is too close to the camera. This can be mitigated by reducing the brightness of the camera flash, for example by using a diffuser.

Other external flash units

Note the following when using a third-party flash unit mounted on the camera hot shoe:

- Using obsolete flash units that apply currents of more than about 250 V to the X-contact will damage the camera.
- Connecting flash units with signal contacts that do not conform to our specifications may damage the camera.
- Select mode **M**, choose a shutter speed no faster than the flash sync speed, and set [ ISO] to **[AUTO]**.
- Flash control can only be performed by manually setting the flash to the ISO sensitivity and aperture values selected with the camera. Flash brightness can be adjusted by adjusting either ISO sensitivity or aperture.
- Use a flash with an angle of illumination suited to the lens. Angle of illumination is usually expressed using 35-mm format equivalent focal lengths.

Principal Accessories

Converter lenses

Converter lenses attach to the camera lens for quick and easy fish-eye or macro photography. See our website for information on the lenses that can be used.

Eyecup (EP-16)

You can switch to a large-size eyecup.

Removal

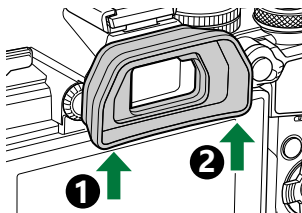

Accessories

For the latest information, please visit our website.

Power Supply

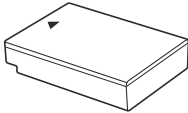

Lithium-ion battery
BLS-50

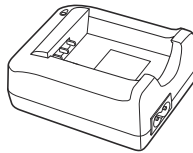

Lithium-ion Charger
BCS-5

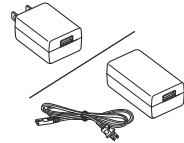

USB-AC Adapter
F-5AC

Viewfinder

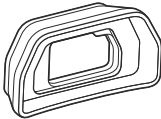

Eyecup
EP-16/EP-15

Remote Operation

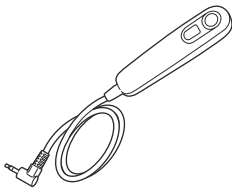

Remote Cable
RM-CB2

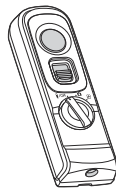

Remote Control
RM-WR1

Lens

Micro Four Thirds system lenses

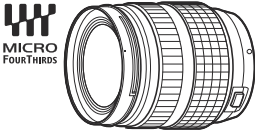

Four Thirds system lenses

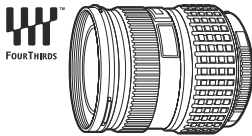

- An MMF-2 or MMF-3 Four Thirds Adapter is required when using this camera with Four Thirds system lenses.
- There are restrictions on the lenses that can be used with the adapter. Visit our website for details.

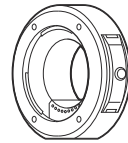

Four Thirds Adapter
MMF-2/MMF-3

Converter lenses

- **FCON-P01** (fisheye)
- **WCON-P01** (wide)
- **MCON-P01** (macro)
- **MCON-P02** (macro)

Visit our website for information on compatible lenses.

Flash

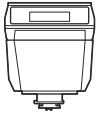

Electronic Flash
FL-LM3

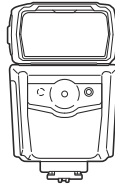

Electronic Flash
FL-900R

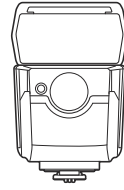

Electronic Flash
FL-700WR

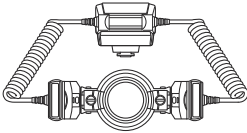

Macro Flash
STF-8

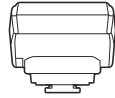

Wireless radiowave commander
FC-WR

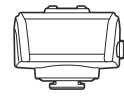

Wireless radiowave receiver
FR-WR

Grip

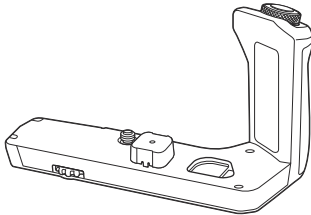

Grip
ECG-5

Case/Strap

- Camera case
- Strap

Connection Cable

- USB cable
- HDMI cable (available from third-party suppliers)

Memory Card

- SD
- SDHC
- SDXC

Memory cards are available from third-party suppliers.

Microphone

Microphones are available from third-party suppliers.

Software

Digital photo management and editing software

OM Workspace

Smartphone app

OM Image Share

Cleaning and storing the camera

Cleaning the camera

Turn off the camera and remove the battery before cleaning the camera.

- Do not use strong solvents such as benzene or alcohol, or a chemically treated cloth.

Exterior:

- Wipe gently with a soft cloth. If the camera is very dirty, soak the cloth in mild soapy water and wring well. Wipe the camera with the damp cloth and then dry it with a dry cloth. If you have used the camera at the beach, use a cloth soaked in clean water and well wrung.

Monitor:

- Wipe gently with a soft cloth.

Lens:

- Blow dust off the lens with a commercially available blower. For the lens, wipe gently with a lens cleaning paper.

Storage



- When not using the camera for a prolonged period, remove the battery and card. Store the camera in a cool, dry place that is well ventilated.
- Insert the battery periodically and test the camera's functions.
- Remove dust and other foreign matter from the body and rear caps before attaching them.
- Attach the body cap to the camera to prevent dust from getting inside when no lens is attached. Be sure to replace the front and rear lens caps before putting the lens away.
- Clean the camera after use.
- Do not store with insect repellent.
- Avoid storing the camera in places where chemicals are treated, in order to protect the camera from corrosion.
- Mold may form on the lens surface if the lens is left dirty.
- Check each part of the camera before use if it has not been used for a long time. Before taking important pictures, be sure to take a test shot and check that the camera works properly.

Inspecting and Cleaning the Image Sensor

This camera incorporates a dust reduction function to keep dust from getting on the image sensor and to remove any dust or dirt from the image sensor surface with ultrasonic vibrations. The dust reduction function operates when the camera is turned on. The dust reduction function operates at the same time as the pixel mapping, which checks the image sensor and image processing circuitry. Since dust reduction is activated every time the camera's power is turned on, the camera should be held upright for the dust reduction function to be effective.

Pixel Mapping - Checking the image processing functions

The pixel mapping feature allows the camera to check and adjust the image sensor and image processing functions. For best results, wait at least a minute after shooting and playback have ended before performing pixel mapping.

1. Highlight **[Pixel Mapping]** in  Custom Menu  (P. 295).
 2. Press the  button and then the **OK** button.
 - The **[Busy]** bar is displayed when pixel mapping is in progress. When pixel mapping is finished, the menu is restored.
- If you accidentally turn the camera off during pixel mapping, start again from Step 1.

Shooting tips and information

The camera does not turn on even when a battery is loaded

The battery is not fully charged

- Charge the battery using a USB-AC adapter or battery charger.

The battery is temporarily unable to function because of the cold

- Battery performance drops at low temperatures. Remove the battery and warm it by putting it in your pocket for a while.

A dialog prompting you to choose a language is displayed

The dialog is displayed in the following situations.



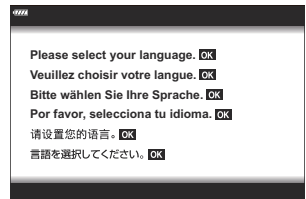



- The camera is turned on for the first time.
- You have not chosen a language.





See "Initial setup" (P. 34) for information on choosing a language.

No picture is taken when the shutter button is pressed

The camera has turned off automatically

- If **[On]** is selected for **[Quick Sleep Mode]**, the camera will enter sleep mode if no operations are performed for a set period. Press the shutter button halfway to exit sleep mode.   **Custom Menu**  **> [Quick Sleep Mode]** (P. 296)
- The camera automatically enters sleep mode to reduce the drain on the battery if no operations are performed for a set period of time.   **Custom Menu**  **> [Sleep]** (P. 296)

- If no operations are performed for a set time after the camera has entered sleep mode, the camera will turn off automatically.   Custom Menu  > **[Auto Power Off]** (P. 296)

The flash is charging

- On the monitor, the  mark blinks when charging is in progress. Wait for the blinking to stop, then press the shutter button.

Unable to focus

- The camera cannot focus on subjects that are too close to the camera or that are not suited to autofocus (the AF confirmation mark will blink in the monitor). Increase the distance to the subject or focus on a high contrast object at the same distance from the camera as your main subject, compose the shot, and shoot.

Subjects that are difficult to focus on

It may be difficult to focus with auto focus in the following situations.

- AF confirmation mark is blinking.

These subjects are not focused.

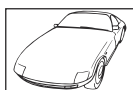

Subject with low contrast



Excessively bright light in center of frame

- AF confirmation mark lights up but the subject is not focused.



Subjects at different distances

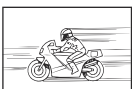



Fast-moving subject



Subject not inside AF area

Noise reduction is activated

- When shooting night scenes, shutter speeds are slower and noise tends to appear in images. The camera activates the noise-reduction process after shooting at slow shutter speeds. During which, shooting is not allowed. You can set **[Noise Reduct.]** to **[Off]**.   Custom Menu  > **[Noise Reduct.]** (P. 284)

The number of AF targets is reduced

The size and number of available AF targets vary with group target settings (P. 91) and the options chosen for **[Digital Tele-converter]** (P. 208) and **[Aspect]** (P. 138).

The date and time has not been set

The camera is used with the settings at the time of purchase

- The date and time of the camera is not set when purchased. Set the date and time before using the camera. 🖱️ [“Initial setup” \(P. 34\)](#)

The battery has been removed from the camera

- The date and time settings will be returned to the factory default settings if the camera is left without the battery for approximately 1 day (in-house measurements). The settings will be canceled more quickly if the battery was only loaded in the camera for a short time before being removed. Before taking important pictures, check that the date and time settings are correct.

Set functions are restored to their factory default settings

- Settings altered in **AUTO** (📷) and **SCN** modes are reset to default values when the mode dial is rotated to another setting or the camera is turned off.
- Settings altered in custom modes (**C-C4**) are reset to saved values when the mode dial is rotated to another setting or the camera is turned off. Note, however, that if **[Hold]** is selected for **[Reset / Custom Modes]** > **[Custom Mode Save Settings]** in 📷 Shooting Menu 1 when a custom mode is selected, changes to settings will automatically be saved to the selected mode. 🖱️ [“Updating Custom Modes Automatically” \(P. 81\)](#)

Pictures are “washed out”

This may occur when the picture is taken in backlight or semi-backlight conditions. This is due to a phenomenon called flare or ghosting. As far as possible, consider a composition where strong light source is not taken in the picture. Flare may occur even when a light source is not present in the picture. Use a lens hood to shade the lens from the light source. If a lens hood does not have effect, use your hand to shade the lens from the light.

Unknown bright dot(s) appear on the subject in the picture taken

This may be due to stuck pixel(s) on the image sensor. Perform **[Pixel Mapping]**. If the problem persists, repeat pixel mapping a few times. 📖 [“Pixel Mapping - Checking the image processing functions” \(P. 444\)](#)

Functions that cannot be selected from menus

Some items may not be selectable from the menus when using the arrow pad.

- Items that cannot be set with the current shooting mode.
- Items that cannot be set because of an item that has already been set:
 - Combinations of [\[!\[\]\(cdf2842d82858164c68c92720a337fb9_img.jpg\)\] \(P. 101\)](#) and [\[Noise Reduct.\] \(P. 284\)](#), etc.

Functions that cannot be set from the super control panel

Some functions may be unavailable depending on the current shooting settings. Check if the same function is displayed in gray in the menus.

The subject appears distorted

The following functions use an electronic shutter:



- [movie recording \(P. 82\)](#), [silent mode \(P. 106\)](#), [Pro Capture \(P. 107\)](#), [High Res Shot \(P. 109\)](#), [focus bracketing \(P. 216\)](#), [focus stacking \(P. 216\)](#), and [the live ND filter \(P. 213\)](#)

This may cause distortion if the subject is moving rapidly or the camera is moved abruptly. Avoid moving the camera abruptly during shooting or use standard sequential shooting.

Lines appear in photographs

The following functions use an electronic shutter, which may result in lines due to flicker and other phenomena associated with fluorescent and LED lighting:

- [movie recording \(P. 82\)](#), [silent mode \(P. 106\)](#), [Pro Capture \(P. 107\)](#), [High Res Shot \(P. 109\)](#), [focus bracketing \(P. 216\)](#), [focus stacking \(P. 216\)](#), and [the live ND filter \(P. 213\)](#)

Flicker can be reduced by choosing slower shutter speeds. You can also reduce flicker using flicker scan.  [Custom Menu](#)  > [\[Flicker Scan\]](#) (P. 343),  [Video Menu](#) > [\[Mode Settings\]](#) > [\[Flicker Scan\]](#) (P. 240)

Only the subject is displayed and no information is shown

The display has been switched to “image only”. Press the **INFO** button and switch to another display mode.







Focus mode cannot be changed from MF (manual focus)





The lens you are using may be equipped with the MF clutch mechanism. In this case, manual focus is selected when the focus ring is slid to the camera body side. Check the lens.  [“MF Clutch Lenses”](#) (P. 429)

Nothing is displayed on the monitor

When something, e.g. your face, hand or strap, comes close to the viewfinder, the monitor turns off and the viewfinder turns on.  [“Switching between displays”](#) (P. 40)

Error codes

Monitor indication	Possible cause/Corrective action
 No Card	No card inserted or card not recognized. Insert a card or remove and reinsert the current card.
 Card Error	There is a problem with the card. Insert the card again. If the problem persists, format the card. If the card cannot be formatted, it cannot be used.
 Write Protect	Writing to the card is prohibited. The card write-protect switch is set to the "LOCK" side. Return the switch to the unlocked position (P. 28).
 Card Full	The card is full and no additional pictures can be taken. Replace the card or erase unwanted pictures. Before deleting pictures, be sure any you wish to keep have been copied to a computer.
 Card Full	There is not enough space on the memory card to record additional pictures. Replace the card or erase unwanted pictures. Before deleting pictures, be sure any you wish to keep have been copied to a computer.
 No Picture	There are no pictures to play back. The card contains no pictures. Take pictures before beginning playback.
 Picture Error	The selected file is damaged and cannot be played back. Alternatively, the picture is in a format that is not supported by the camera. View the picture using computer imaging software or the like. If the picture cannot be displayed on a computer, the file may be corrupt.



Monitor indication	Possible cause/Corrective action
 <p>The Image Cannot Be Edited</p>	<p>Camera retouch features cannot be applied to pictures recorded with other devices.</p> <p>Retouch the picture on a computer or other device.</p>
<p>Y/M/D</p>	<p>The clock is not set.</p> <p>Set the clock (P. 34).</p>
	<p>The internal temperature of the camera has risen due to sequential shooting.</p> <p>Turn off the camera and wait for the internal temperature to cool.</p>
 <p>Internal camera temperature is too high. Please wait for cooling before camera use.</p>	<p>The internal temperature of the camera has risen due to sequential shooting.</p> <p>Wait a moment for the camera to turn off automatically. Allow the internal temperature of the camera to cool before resuming operations.</p>
 <p>Battery Empty</p>	<p>The battery is drained.</p> <p>Charge the battery.</p>
 <p>No Connection</p>	<p>The camera is not correctly connected to a computer, HDMI display, or other device.</p> <p>Reconnect the camera.</p>
<p>The lens is locked. Please extend the lens.</p>	<p>The lens of the retractable lens stays retracted.</p> <p>Extend the lens.</p>
<p>Please check the status of a lens.</p>	<p>An abnormality has occurred between the camera and the lens.</p> <p>Turn off the camera, check the connection with the lens, and turn the power on again.</p>

Specifications

Camera

Product type	
Product type	Digital camera with interchangeable Micro Four Thirds Standard lens system
Lens	M.ZUIKO DIGITAL, Micro Four Thirds System Lens
Lens mount	Micro Four Thirds mount
Equivalent focal length on a 35 mm film camera	Approx. twice the focal length of the lens
Image sensor	
Product type	4/3" Live MOS sensor
Total no. of pixels	Approx. 21.77 million pixels
No. of effective pixels	Approx. 20.37 million pixels
Screen size	17.4 mm (H) × 13.0 mm (V)
Aspect ratio	1.33 (4:3)
Viewfinder	
Type	Electronic viewfinder with eye sensor
No. of pixels	Approx. 2.36 million dots
Magnification	100%
Eye point	Approx. 27 mm (−1 m–1)

Live view	
Sensor	Uses Live MOS sensor
Magnification	100%
Monitor	
Product type	3.0" TFT color LCD, Vari-angle, touch screen
Total no. of pixels	Approx. 1.04 million dots (aspect ratio 3:2)
Shutter	
Product type	Computerized focal-plane shutter
Shutter speed	1/8000 – 60 sec., bulb photography, time photography
Flash sync speed	Up to 1/250 sec.
Auto focus	
Product type	Hi-Speed Imager AF
Focusing points	121 points
Selection of focusing point	Auto, Optional

Exposure control	
Metering system	TTL metering system (imager metering) Digital ESP metering/Center weighted averaging metering/Spot metering
Metered range	-2 to 20 EV (f/2.8, ISO 100 equivalent)
Shooting modes	 : Auto; P : Program AE (program shift available); A : Aperture priority AE; S : Shutter-priority AE; M : Manual; B : Bulb (bulb, time, and composite); C – C4 : Custom Modes;  : Movie; ART : Art Filter; SCN : Scene
ISO sensitivity	L64; L100; 200 – 25600 in steps of 1/3 or 1 EV
Exposure compensation	±5.0 EV in steps of 1/3, 1/2, or 1 EV
White balance	
Mode setting	Auto/Preset WB (7 settings)/Customized WB/One-touch WB (camera can store up to 4 settings)
Recording	
Memory	SD, SDHC and SDXC UHS-II compatible
Recording system	Digital recording, JPEG (DCF2.0), RAW Data
Compatible standards	Exif 2.31, Digital Print Order Format (DPOF)
Sound with still pictures	Wave format
Movie	MPEG-4 AVC/H.264
Audio	Stereo linear PCM, 16-bit; sampling frequency 48 kHz (wave format) Stereo linear PCM, 24-bit; sampling frequency 96 kHz (wave format)

Playback	
Display format	Single-frame playback; close-up playback; index display; calendar display
Drive	
Drive mode	Single frame; sequential; anti-shock; silent; Pro Capture; self-timer; High Res Shot
Sequential shooting	Up to 10 fps (📹) Up to 30 fps (♥📹, Pro CapH)
Self-timer	Operation time: 12 sec.; 2 sec.; custom
Flash	
Flash control mode	TTL-AUTO (TTL pre-flash mode); MANUAL
X-Sync.	Up to 1/250 sec.
Wireless LAN	
Compatible standards	IEEE 802.11b/g/n
Bluetooth®	
Compatible standards	Bluetooth Version 4.2 BLE
External connectors	
Micro USB; HDMI (Type D)	
Power supply	
Battery	Lithium-ion battery × 1
Energy saving function	Switch to sleep mode: 1 minute; Power OFF: 4 hours (can be customized)

Dimensions/weight

Dimensions

Approx. 125.3 mm (W) × 85.2 mm (H) × 49.7 mm (D) (4.9" × 3.4" × 2.0") (excluding protrusions)

Weight

Approx. 414 g (0.9 lb.) (including battery and memory card)

Operating environment

Temperature

-10 °C – 40 °C (14 °F - 104 °F) (operation)/ -20 °C – 60 °C (-4 °F – 140 °F) (storage)

Humidity

30% – 90% (operation)/10% – 90% (storage)

Water resistance

Type: IEC Standard publication 60529 IPX3 (applies if camera is used with one of our water-resistant lenses)

Lithium-ion battery

MODEL NO.	BLS-50
Product type	Rechargeable Lithium ion battery
Nominal voltage	DC 7.2 V
Nominal capacity	1210 mAh
No. of charge and discharge times	Approx. 500 times (varies with usage conditions)
Ambient temperature	0 °C – 40 °C (32 °F – 104 °F) (charging)
Dimensions	Approx. 35.5 mm (W) × 12.8 mm (H) × 55 mm (D) (1.4" × 0.5" × 2.2")
Weight	Approx. 46 g (0.1 lb.)

USB-AC adapter

MODEL NO.	F-5AC-1/F-5AC-2
Rated input	AC 100 V – 240 V (50/60 Hz)
Rated output	DC 5 V, 1500 mA
Ambient temperature	0 °C – 40 °C (32 °F – 104 °F) (operation)/–20 °C – 60 °C (–4 °F – 140 °F) (storage)







- SPECIFICATIONS ARE SUBJECT TO CHANGE WITHOUT ANY NOTICE OR OBLIGATION ON THE PART OF THE MANUFACTURER.
- Visit our website for the latest specifications.

The terms HDMI and HDMI High-Definition Multimedia Interface, and the HDMI Logo are trademarks or registered trademarks of HDMI Licensing Administrator, Inc. in the United States and other countries.



SAFETY PRECAUTIONS

SAFETY PRECAUTIONS

	CAUTION RISK OF ELECTRIC SHOCK DO NOT OPEN	
CAUTION: TO REDUCE THE RISK OF ELECTRICAL SHOCK, DO NOT REMOVE COVER (OR BACK). NO USER-SERVICEABLE PARTS INSIDE. REFER SERVICING TO QUALIFIED SERVICE PERSONNEL.		
	An exclamation mark enclosed in a triangle alerts you to important operating and maintenance instructions in the documentation provided with the product.	
 WARNING	If the product is used without observing the information given under this symbol, serious injury or death may result.	
 CAUTION	If the product is used without observing the information given under this symbol, injury may result.	
 NOTICE	If the product is used without observing the information given under this symbol, damage to the equipment may result.	
WARNING! TO AVOID THE RISK OF FIRE OR ELECTRICAL SHOCK, NEVER DISASSEMBLE, EXPOSE THIS PRODUCT TO WATER OR OPERATE IN A HIGH HUMIDITY ENVIRONMENT.		

General Precautions

Read All Instructions — Before you use the product, read all operating instructions. Save all manuals and documentation for future reference.

Power Source — Connect this product only to the power source described on the product label.

Foreign Objects — To avoid personal injury, never insert a metal object into the product.

Cleaning — Always unplug this product from the wall outlet before cleaning. Use only a damp cloth for cleaning. Never use any type of liquid or aerosol cleaner, or any type of organic solvent to clean this product.

Heat — Never use or store this product near any heat source such as a radiator, heat register, stove, or any type of equipment or appliance that generates heat, including stereo amplifiers.

Lightning — If a lightning storm occurs while using a USB-AC adapter, remove it from the wall outlet immediately.

Attachments — For your safety, and to avoid damaging the product, use only accessories recommended by our company.

Location — To avoid damage to the product, mount the product securely on a stable tripod, stand, or bracket.

WARNING

- **Do not use the camera near flammable or explosive gases.**
- **Rest your eyes periodically when using the viewfinder.**

Failure to observe this precaution could result in eyestrain, nausea, or sensations similar to motion sickness. The length and frequency of the required rest varies with the individual; use your own judgement. If you feel tired or unwell, avoid using the viewfinder and if necessary consult a physician.
- **Do not use the flash and LED (including AF illuminator) on people (infants, small children, etc.) at close range.**
 - You must be at least 1 m (3 ft.) away from the faces of your subjects. Firing the flash too close to the subject's eyes could cause a momentary loss of vision.
- **Do not look at the sun or strong lights with the camera.**
- **Keep young children, infants away from the camera.**
 - Always use and store the camera out of the reach of young children and infants to prevent the following dangerous situations which could cause serious injury:
 - Becoming entangled in the camera strap, causing strangulation.
 - Accidentally swallowing the battery, cards or other small parts.
 - Accidentally firing the flash into their own eyes or those of another child.
 - Accidentally being injured by the moving parts of the camera.
- **If you find that the USB-AC adapter or charger is extremely hot or notice any unusual odors, noise, or smoke around it, unplug the power plug from wall outlet immediately and stop using it. Then, contact an authorized distributor or service center.**
- **Stop using the camera immediately if you notice any unusual odors, noise, or smoke around it.**
 - Never remove the batteries with bare hands, which may cause a fire or burn your hands.
- Never hold or operate the camera with wet hands.

This may cause overheating, exploding, burning, electrical shocks, or malfunctions.
- **Do not leave the camera in places where it may be subject to extremely high temperatures.**
 - Doing so may cause parts to deteriorate and, in some circumstances, cause the camera to catch fire. Do not use the charger or USB-AC adapter if it is covered (such as a blanket). This could cause overheating, resulting in fire.
- **Handle the camera with care to avoid getting a low temperature burn.**
 - When the camera contains metal parts, overheating can result in a low-temperature burn. Pay attention to the following:
 - When used for a long period, the camera will get hot. If you hold on to the camera in this state, a low-temperature burn may be caused.
 - In places subject to extremely cold temperatures, the temperature of the camera's body may be lower than the environmental temperature. If possible, wear gloves when handling the camera in cold temperatures.
- To protect the high-precision technology contained in this product, never leave the camera in the places listed below, no matter if in use or storage:

- Places where temperatures and/or humidity are high or go through extreme changes. Direct sunlight, beaches, locked cars, or near other heat sources (stove, radiator, etc.) or humidifiers.
- In sandy or dusty environments.
- Near flammable items or explosives.
- In wet places, such as bathrooms or in the rain.
- In places prone to strong vibrations.
- The camera uses a lithium ion battery specified by our company. Charge the battery with the specified USB-AC adapter or charger. Do not use any other USB-AC adapters or chargers.
- Never incinerate or heat batteries in microwaves, on hot plates, or in pressure vessels, etc.
- Never leave the camera on or near electromagnetic devices.
This may cause overheating, burning, or exploding.
- Do not connect terminals with any metallic objects.
- Take precautions when carrying or storing batteries to prevent them from coming into contact with any metal objects such as jewelry, pins, fasteners, keys, etc.
The short circuit may cause overheating, exploding, or burning, which burn or damage you.
- To prevent causing battery leaks or damaging their terminals, carefully follow all instructions regarding the use of batteries. Never attempt to disassemble a battery or modify it in any way, solder, etc.
- If battery fluid gets into your eyes, flush your eyes immediately with clear, cold running water and seek medical attention immediately.
- If you cannot remove the battery from the camera, contact an authorized distributor or service center. Do not try to remove the battery by force.
Damage to the battery exterior (scratches, etc.) may produce heat or an explosion.
- Always store batteries out of the reach of small children and pets. If they accidentally swallow a battery, seek medical attention immediately.
- To prevent batteries from leaking, overheating, or causing a fire or explosion, use only batteries recommended for use with this product.
- If rechargeable batteries have not been recharged within the specified time, stop charging them and do not use them.
- Do not use batteries with scratches or damage to the casing, and do not scratch the battery.
- Never subject batteries to strong shocks or continuous vibration by dropping or hitting.
This may cause exploding, overheating, or burning.
- If a battery leaks, has unusual odor, becomes discolored or deformed, or becomes abnormal in any other way during operation, stop using the camera, and keep away from fire immediately.
- If a battery leaks fluid onto your clothing or skin, remove the clothing and flush the affected area with clean, running cold water immediately. If the fluid burns your skin, seek medical attention immediately.
- Never use lithium-ion batteries in a low-temperature environment. Doing so may cause generation of heat, ignition, or explosion.
- The lithium-ion battery is designed to be used only for the digital camera. Do not use the battery to other devices.
- **Do not allow children or animals/pets to handle or transport batteries (prevent dangerous behaviour such as licking, putting in mouth or chewing).**

Use Only Dedicated Rechargeable Battery, Battery Charger and USB-AC adapter

We strongly recommend that you use only the genuine rechargeable battery, battery charger, and USB-AC adapter specified by our company with this camera. Using a non-genuine rechargeable battery, battery charger and/or USB-AC adapter may result in fire or personal injury due to leakage, heating, ignition or damage to the battery. Our company does not assume any liability for accidents or damage that may result from the use of a battery, battery charger, and/or USB-AC adapter that are not specified genuine accessories.

CAUTION

- **Do not cover the flash with a hand while firing.**
- The included USB-AC adapter F-5AC is designed to be used only with this camera. Other cameras cannot be charged with this USB-AC adapter.
- Do not connect the included USB-AC adapter F-5AC to equipment other than this camera.
- Never store batteries where they will be exposed to direct sunlight, or subjected to high temperatures in a hot vehicle, near a heat source, etc.
- Keep batteries dry at all times.
- The battery may become hot during prolonged use. To avoid minor burns, do not remove it immediately after using the camera.
- This camera uses one of our lithium-ion batteries. Use the specified genuine battery. There is a risk of explosion if the battery is replaced with the incorrect battery type.
- Please recycle batteries to help save our planet's resources. When you throw away dead batteries, be sure to cover their terminals and always observe local laws and regulations.

NOTICE

- **Do not use or store the camera in dusty or humid places.**
 - **Use SD/SDHC/SDXC memory cards only. Never use other types of cards.**

If you accidentally insert another type of card into the camera, contact an authorized distributor or service center. Do not try to remove the card by force.
 - Regularly back up important data to a computer or other storage device to prevent accidental loss.
 - Our company accepts no liability for any loss of data associated with this device.
 - Be careful with the strap when you carry the camera. It could easily catch on stray objects and cause serious damage.
 - Before transporting the camera, remove a tripod and all other accessories made by other companies.
 - Never drop the camera or subject it to severe shocks or vibrations.
 - When attaching the camera to or removing it from a tripod, rotate the tripod screw, not the camera.
 - Do not touch electric contacts on cameras.
-

- Do not leave the camera pointed directly at the sun. This may cause lens or shutter curtain damage, color failure, ghosting on the image sensor, or may possibly cause fires.
- Do not leave the viewfinder exposed to a strong light source or direct sunlight. The heat may damage the viewfinder.
- Do not push or pull severely on the lens.
- Be sure to remove any water droplets or other moisture from the product before replacing the battery or opening or closing covers.
- Before storing the camera for a long period, remove the batteries. Select a cool, dry location for storage to prevent condensation or mold from forming inside the camera. After storage, test the camera by turning it on and pressing the shutter button to make sure that it is operating normally.
- The camera may malfunction if it is used in a location where it is subject to a magnetic/ electromagnetic field, radio waves, or high voltage, such as near a TV set, microwave, video game, loud speakers, large monitor unit, TV/radio tower, or transmission towers. In such cases, turn the camera off and on again before further operation.
- Always observe the operating environment restrictions described in the camera's manual.
- Insert the battery carefully as described in the operating instructions.
- Before loading, always inspect the battery carefully for leaks, discoloration, warping, or any other abnormality.
- Always unload the battery from the camera before storing the camera for a long period.
- When storing the battery for a long period, select a cool location for storage.
- For plug-in type USB-AC adapter:
Connect the plug-in type USB-AC adapter F-5AC correctly by plugging it vertically into the wall outlet.
- As the main plug of AC adapter is used to disconnect the AC adapter from the mains, connect it to an easily accessible AC outlet.
- Power consumption by the camera varies depending on which functions are used.
- During the conditions described below, power is consumed continuously and the battery becomes exhausted quickly.
 - The zoom is used repeatedly.
 - The shutter button is pressed halfway repeatedly in shooting mode, activating the auto focus.
 - A picture is displayed on the monitor for an extended period of time.
- Using an exhausted battery may cause the camera to turn off without displaying the battery level warning.
- If the battery's terminals get wet or greasy, camera contact failure may result. Wipe the battery well with a dry cloth before use.
- Always charge a battery when using it for the first time, or if it has not been used for a long period.
- When operating the camera with battery power at low temperatures, try to keep the camera and spare battery as warm as possible. A battery that has run down at low temperatures may be restored after it is warmed at room temperature.
- Before going on a long trip, and especially before traveling abroad, purchase extra batteries. A recommended battery may be difficult to obtain while traveling.

Using the wireless LAN/Bluetooth® functions

- **Turn off the camera in hospitals and other locations where medical equipment is present.**

The radio waves from the camera may adversely affect medical equipment, causing a malfunction that results in an accident. Be sure to disable wireless LAN/Bluetooth® functions in the vicinity of medical equipment (P. 357).

- **Turn off the camera when onboard aircraft.**

Using wireless devices onboard may hinder safe operation of the aircraft. Be sure to disable wireless LAN/Bluetooth® functions onboard aircraft (P. 357).

Monitor

- Do not push the monitor forcibly; otherwise the image may become vague, resulting in a playback mode failure or damage to the monitor.
- A strip of light may appear on the top/bottom of the monitor, but this is not a malfunction.
- When a subject is viewed diagonally in the camera, the edges may appear zigzagged on the monitor. This is not a malfunction; it will be less noticeable in playback mode.
- In places subject to low temperatures, the monitor may take a long time to turn on or its color may change temporarily.

When using the camera in extremely cold places, it is a good idea to occasionally place it in a warm place. The monitor exhibiting poor performance due to low temperatures will recover in normal temperatures.

- The monitor of this product is manufactured with high-quality accuracy, however, there may be a stuck or dead pixel on the monitor. These pixels do not have any influence on the image to be saved. Because of the characteristics, the unevenness of the color or brightness may also be found depending on the angle, but this is due to the structure of the monitor. This is not a malfunction.

Legal and Other Notices

- Our company makes no representations or warranties regarding any damages, or benefit expected by using this unit lawfully, or any request from a third person, which are caused by the inappropriate use of this product.
- Our company makes no representations or warranties regarding any damages or any benefit expected by using this unit lawfully which are caused by erasing picture data.

Disclaimer of Warranty

- Our company makes no representations or warranties, either expressed or implied, by or concerning any content of these written materials or software, and in no event shall be liable for any implied warranty of merchantability or fitness for any particular purpose or for any consequential, incidental or indirect damages (including but not limited to damages for loss of business profits, business interruption and loss of business information) arising from the use or inability to use these written materials or software or equipment. Some countries do not allow the exclusion or limitation of liability for consequential or incidental damages or of the implied warranty, so the above limitations may not apply to you.

- Our company reserves all rights to this manual.

Warning

Unauthorized photographing or use of copyrighted material may violate applicable copyright laws. Our company assumes no responsibility for unauthorized photographing, use or other acts that infringe upon the rights of copyright owners.

Copyright Notice

All rights reserved. No part of these written materials or this software may be reproduced or used in any form or by any means, electronic or mechanical, including photocopying and recording or the use of any type of information storage and retrieval system, without the prior written permission of our company. No liability is assumed with respect to the use of the information contained in these written materials or software, or for damages resulting from the use of the information contained therein. Our company reserves the right to alter the features and contents of this publication or software without obligation or advance notice.

Trademarks

- Microsoft and Windows are registered trademarks of Microsoft Corporation.
- SDXC Logo is a trademark of SD-3C, LLC.
- Apical logo is a registered trademark of Apical Limited.



- Micro Four Thirds, Four Thirds, and the Micro Four Thirds and Four Thirds logos are trademarks or registered trademarks of the OM Digital Solutions Corporation in Japan, the United States, the countries of the European Union, and other countries.
- Wi-Fi is a registered trademark of the Wi-Fi Alliance.
- The **Bluetooth**® word mark and logos are registered trademarks owned by the Bluetooth SIG, Inc. and any use of such marks by OM Digital Solutions Corporation is under license.
- The standards for camera file systems referred to in this manual are the "Design Rule for Camera File System/DCF" standards stipulated by the Japan Electronics and Information Technology Industries Association (JEITA).
- All other company and product names are registered trademarks and/or trademarks of their respective owners. "™" and "®" symbols may sometimes be omitted.

THIS PRODUCT IS LICENSED UNDER THE AVC PATENT PORTFOLIO LICENSE FOR THE PERSONAL AND NONCOMMERCIAL USE OF A CONSUMER TO (i) ENCODE VIDEO IN COMPLIANCE WITH THE AVC STANDARD ("AVC VIDEO") AND/OR (ii) DECODE AVC VIDEO THAT WAS ENCODED BY A CONSUMER ENGAGED IN A PERSONAL AND NON-COMMERCIAL ACTIVITY AND/OR WAS OBTAINED FROM A

VIDEO PROVIDER LICENSED TO PROVIDE AVC VIDEO. NO LICENSE IS GRANTED OR SHALL BE IMPLIED FOR ANY OTHER USE. ADDITIONAL INFORMATION MAY BE OBTAINED FROM MPEG LA, L.L.C. SEE [HTTP://WWW.MPEGLA.COM](http://www.mpegla.com)

The software in this camera may include third party software. Any third party software is subject to the terms and conditions, imposed by the owners or licensors of that software, under which software is provided to you.

Those terms and other third party software notices, if any, may be found in the software notice PDF file stored at

<https://cs.olympus-imaging.jp/en/support/imshow/digicamera/download/notice/notice.cfm>

date of issue 2022.10.



<https://om-digitalsolutions.com/>